



**Technical and Test Institute
for Construction Prague**

Prosecká 811/76a
190 00 Prague
Czech Republic
eota@tzus.cz



Member of



www.eota.eu

European Technical Assessment

ETA 22/0820 of 13/01/2023

(English language translation, the original version in Czech language)

Technical Assessment Body issuing the ETA: Technical and Test Institute
for Construction Prague

Trade name of the construction product

SCELLEMENT VINYLESTERE FIXH

**Product family to which the
construction product belongs**

Product area code: 33
Injection anchors for use in masonry

Manufacturer

SOGEDESCA
10 Rue General Plessier
Lyon, 69002
France

Manufacturing plant(s)

Plant A

**This European Technical Assessment
contains**

57 pages including 54 Annexes which form
an integral part of this assessment.

**This European Technical Assessment is
issued in accordance with regulation
(EU) No 305/2011, on the basis of**

EAD 330076-01-0604

Translations of this European Technical Assessment in other languages shall fully correspond to the original issued document and should be identified as such.

Communication of this European Technical Assessment, including transmission by electronic means, shall be in full (excepted the confidential Annex(es) referred to above). However, partial reproduction may be made, with the written consent of the issuing Technical Assessment Body - Technical and Test Institute for Construction Prague. Any partial reproduction has to be identified as such.

1. Technical description of the product

The SCHELEMENT VINYLESTERE FIXH for masonry is bonded anchor consisting of a cartridge with injection mortar, a steel element and a plastic sleeve. The steel elements are the commercial threaded rods with hexagon nut and washer. The steel elements are made of galvanized or zinc plated steel, stainless or high corrosion resistance steel.

The anchor is placed into a drilled hole filled with injection mortar. The steel element is anchored via the bond between metal part, injection mortar and masonry.

The illustration and the description of the product are given in Annex A.

2. Specification of the intended use in accordance with the applicable EAD

The performances given in Section 3 are only valid if the anchor is used in compliance with the specifications and conditions given in Annex B.

The provisions made in this European Technical Assessment are based on an assumed working life of the anchor of 50 years. The indications given on the working life cannot be interpreted as a guarantee given by the producer, but are to be regarded only as a means for choosing the products in relation to the expected economically reasonable working life of the works.

3. Performance of the product and references to the methods used for its assessment

3.1 Mechanical resistance and stability (BWR 1)

Essential characteristic	Performance
Characteristic values for resistance	Annex C 6 to C 40
Displacements	Annex C 5 to C 39
Durability	Annex B 1

3.2 Safety in case of fire (BWR 2)

Essential characteristic	Performance
Reaction to fire	Anchorage satisfy requirements for Class A1

3.3 Hygiene, health and environment (BWR 3)

No performance determined.

3.4 General aspects relating to fitness for use

Durability and serviceability are only ensured if the specifications of intended use according to Annex B 1 are taken into account.

4. Assessment and verification of constancy of performance (AVCP) system applied with reference to its legal base

According to the Decision 97/177/EC of the European Commission¹ the system of assessment verification of constancy of performance (see Annex V to Regulation (EU) No 305/2011) given in the following table applies.

Product	Intended use	Level or class	System
Injection anchors for use in masonry	For fixing and/or supporting to masonry, structural elements (which contributes to the stability of the construction works) or heavy units	-	1

¹ Official Journal of the European Communities L 073 of 14.03.1997

5. Technical details necessary for the implementation of the AVCP system, as provided in the applicable EAD

The factory production control shall be in accordance with the control plan which is a part of the technical documentation of this European Technical Assessment. The control plan is laid down in the context of the factory production control system operated by the manufacturer and deposited at Technický a zkušební ústav stavební Praha, s.p.² The results of factory production control shall be recorded and evaluated in accordance with the provisions of the control plan.

Issued in Prague on 13.01.2023

By

Ing. Jiří Studnička, Ph.D.
Head of the Technical Assessment Body

² The control plan is a confidential part of the documentation of the European Technical Assessment, but not published together with the ETA and only handed over to the approved body involved in the procedure of AVCP.

Installation in hollow brick

Threaded rod M8 up to M16 with sleeve

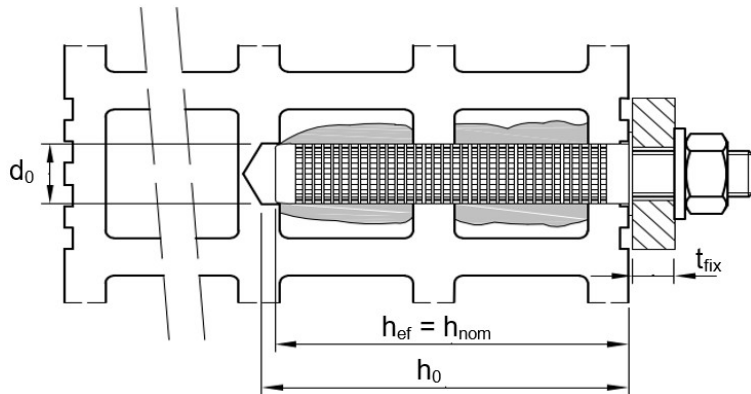

Installation in solid brick

Threaded rod M8 up to M16 with sleeve

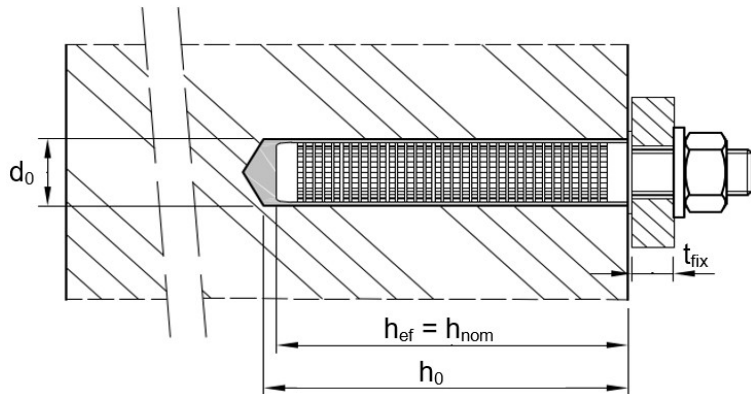

Threaded rod M8 up to M16 without sleeve

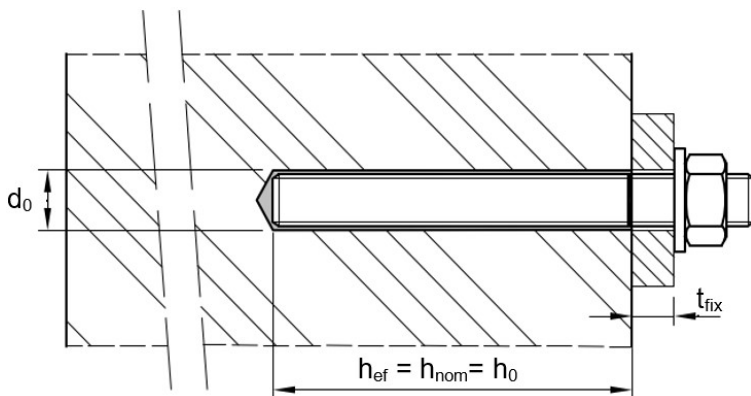

h_{ef} = effective anchorage depth

h_{nom} = overall anchor embedment depth

h_0 = drill hole depth

d_0 = nominal drill hole diameter

t_{fix} = thickness of fixture

SCELLEMENT VINYLESTERE FIXH for masonry

Product description
Installed condition

Annex A 1

Cartridge system

Coaxial Cartridge:

150 ml, 280 ml, 300 ml up to 333 ml and 380 ml up to 420 ml

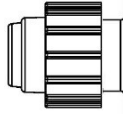

Imprint:

SCELLEMENT VINYLESTERE FIXH

Processing and safety instructions, shelf life, charge number, manufacturer's information, quantity information

Side-by-Side Cartridge:

235 ml, 345 ml up to 360 ml and 825 ml

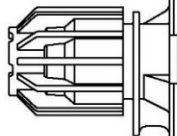

Imprint:

SCELLEMENT VINYLESTERE FIXH

Processing and safety instructions, shelf life, charge number, manufacturer's information, quantity information

Foil Tube Cartridge:

165 ml and 300 ml

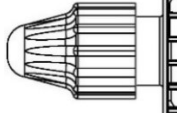

Imprint:

SCELLEMENT VINYLESTERE FIXH

Processing and safety instructions, shelf life, charge number, manufacturer's information, quantity information

Static mixer M17

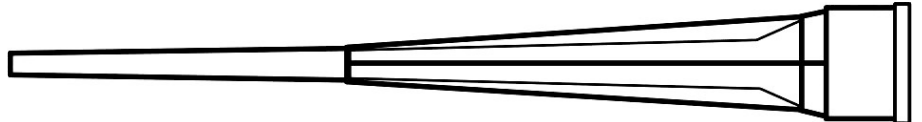

SCELLEMENT VINYLESTERE FIXH for masonry

Product description
Injection system

Annex A 2

Threaded rod M8 up to M16 with washer and hexagon nut

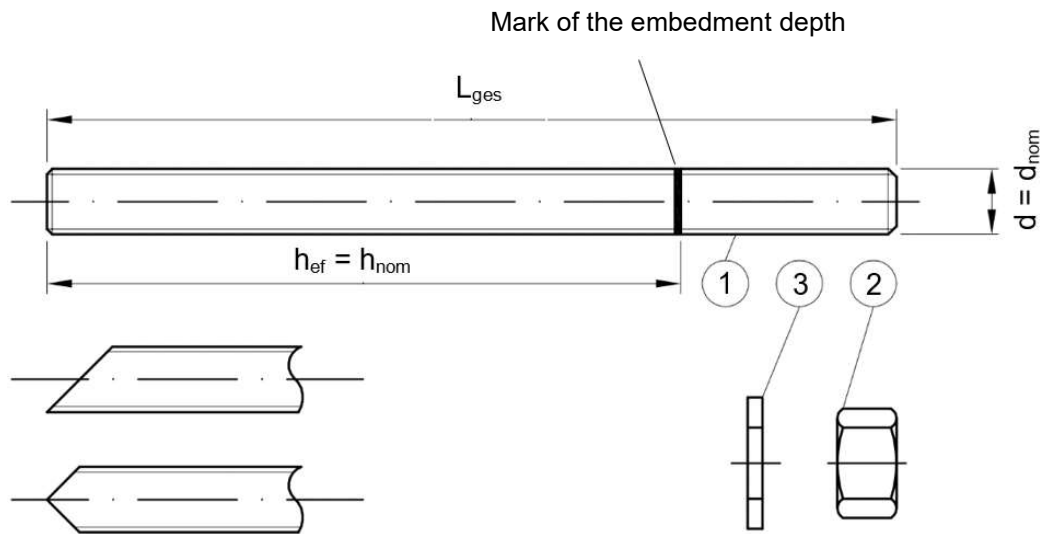

Commercial standard threaded rod with:

- Materials, dimensions and mechanical properties acc. Table A1
- Inspection certificate 3.1 acc. to EN 10204:2004. The document shall be stored.
- Marking of embedment depth

SCELLEMENT VINYLESTERE FIXH for masonry

Product description
Threaded rod

Annex A 3

Table A1: Materials						
Part	Designation	Material				
Steel, zinc plated (Steel acc. to EN ISO 683-4:2018 or EN 10263:2001)						
<ul style="list-style-type: none"> - zinc plated $\geq 5 \mu\text{m}$ acc. to EN ISO 4042:2018 or - hot-dip galvanized $\geq 40 \mu\text{m}$ acc. to EN ISO 1461:2009 and EN ISO 10684:2004+AC:2009 or - sherardized $\geq 45 \mu\text{m}$ acc. to EN ISO 17668:2016 						
1	Anchor rod	Property class	Characteristic steel ultimate tensile strength	Characteristic steel yield strength	Elongation at fracture	
		acc. to EN ISO 898-1:2013	4.6	$f_{uk} = 400 \text{ N/mm}^2$	$f_{yk} = 240 \text{ N/mm}^2$	$A_5 > 8\%$
			4.8	$f_{uk} = 400 \text{ N/mm}^2$	$f_{yk} = 320 \text{ N/mm}^2$	$A_5 > 8\%$
			5.6	$f_{uk} = 500 \text{ N/mm}^2$	$f_{yk} = 300 \text{ N/mm}^2$	$A_5 > 8\%$
			5.8	$f_{uk} = 500 \text{ N/mm}^2$	$f_{yk} = 400 \text{ N/mm}^2$	$A_5 > 8\%$
8.8	$f_{uk} = 800 \text{ N/mm}^2$	$f_{yk} = 640 \text{ N/mm}^2$	$A_5 > 8\%$			
2	Hexagon nut	acc. to EN ISO 898-2:2012	4	for anchor rod class 4.6 or 4.8		
			5	for anchor rod class 5.6 or 5.8		
			8	for anchor rod class 8.8		
3	Washer	Steel, zinc plated, hot-dip galvanized or sherardized (e.g.: EN ISO 887:2006, EN ISO 7089:2000, EN ISO 7093:2000 or EN ISO 7094:2000)				
Stainless steel A2 (Material 1.4301 / 1.4307 / 1.4311 / 1.4567 or 1.4541, acc. to EN 10088-1:2014)						
Stainless steel A4 (Material 1.4401 / 1.4404 / 1.4571 / 1.4362 or 1.4578, acc. to EN 10088-1:2014)						
High corrosion resistance steel (Material 1.4529 or 1.4565, acc. to EN 10088-1: 2014)						
1	Anchor rod ¹⁾	Property class	Characteristic steel ultimate tensile strength	Characteristic steel yield strength	Elongation at fracture	
		acc. to EN ISO 3506-1:2009	50	$f_{uk} = 500 \text{ N/mm}^2$	$f_{yk} = 210 \text{ N/mm}^2$	$A_5 > 8\%$
			70	$f_{uk} = 700 \text{ N/mm}^2$	$f_{yk} = 450 \text{ N/mm}^2$	$A_5 > 8\%$
80	$f_{uk} = 800 \text{ N/mm}^2$		$f_{yk} = 600 \text{ N/mm}^2$	$A_5 > 8\%$		
2	Hexagon nut ¹⁾	acc. to EN ISO 3506-1:2009	50	for anchor rod class 50		
			70	for anchor rod class 70		
			80	for anchor rod class 80		
3	Washer	A2: Material 1.4301, 1.4311 / 1.4307 / 1.4567 or 1.4541, EN 10088-1:2014 A4: Material 1.4401, 1.4404 / 1.4571 / 1.4362 or 1.4578, EN 10088-1:2014 HCR: Material 1.4529 or 1.4565, acc. to EN 10088-1: 2014 (e.g.: EN ISO 887:2006, EN ISO 7089:2000, EN ISO 7093:2000 or EN ISO 7094:2000)				
¹⁾ Property class 80 only for stainless steel A4 and HCR						
Plastic sieve sleeve						
Sieve sleeve BR			Polypropylene (PP)			
SCELLEMENT VINYLESTERE FIXH for masonry					Annex A 4	
Product description Materials						

Table A2: Perforated sleeve

BR 12x80
BR 16x85
BR 20x85

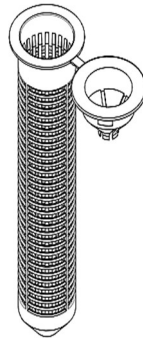
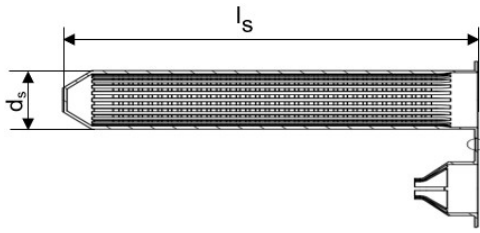

BR 16x130 / 330

For installations through insulation up to a thickness of 20 cm or push through installation

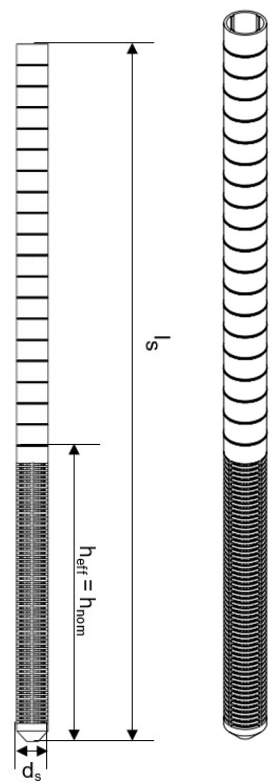

BR 16x130
BR 20x130
BR 20x200

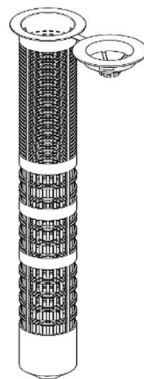
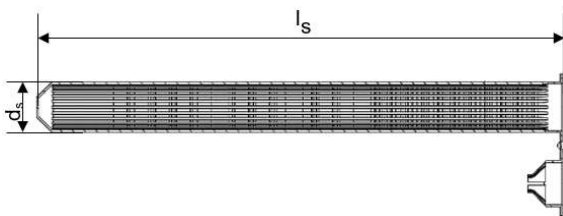

Table A3: Sleeve dimensions

sleeve			
Size [mm]	$d_s = d_{nom}$ [mm]	l_s [mm]	$h_{ef} = h_{nom}$ [mm]
BR 12x80	12	80	80
BR 16x85	16	85	85
BR 16x130	16	130	130
BR 16x130 / 330	16	330	130
BR 20x85	20	85	85
BR 20x130	20	130	130
BR 20x200	20	200	200

SCELLEMENT VINYLESTERE FIXH for masonry

Product description
Sleeves and steel parts

Annex A 5

Specifications of intended use

Anchorage subject to:	Static and quasi-static loads M8 to M16 (with and without perforated sleeve)	
Base material	Masonry group b: Solid brick masonry	Annex B2 and B3.
	Masonry group c: Hollow brick masonry	Annex B2 and B3
	Masonry group d: Autoclaved Aerated Concrete	Annex B2
	Mortar strength class of the masonry M2,5 at minimum according to EN 998-2:2010. For other bricks in solid masonry and in hollow masonry or in autoclaved aerated concrete, the characteristic resistance of the anchor may be determined by job site tests according to EOTA TR 053, Edition April 2016 under consideration of the β -factor according to Annex C1, Table C1.	
Hole drilling	See Annex C 5 – C 40	
Use category	Condition d/d: Installation and use in dry masonry Condition w/w: Installation and use in dry or wet masonry (incl. w/d installation in wet masonry and use in dry masonry)	
Temperature Range:	T _a : - 40°C to +40°C (max. short term temperature +40°C and max. long term temperature +24°C) T _b : - 40°C to +80°C (max. short term temperature +80°C and max. long term temperature +50°C)	

Use conditions (Environmental conditions):

- Dry and wet structures (regarding injection mortar).
- Structures subject to dry internal conditions (zinc coated steel, stainless steel or high corrosion resistant steel).
- Structures subject to external atmospheric exposure (including industrial and marine environment) and to permanently damp internal condition, if no particular aggressive conditions exist (stainless steel or high corrosion resistant steel).
- Structures subject to external atmospheric exposure and to permanently damp internal condition, if other particular aggressive conditions exist (high corrosion resistant steel).

Note: Particular aggressive conditions are e.g. permanent, alternating immersion in seawater or the splash zone of seawater, chloride atmosphere of indoor swimming pools or atmosphere with extreme chemical pollution (e.g. in desulphurization plants or road tunnels where de-icing materials are used).

Design:

- Verifiable calculation notes and drawings are prepared taking account the relevant masonry in the region of the anchorage, the loads to be transmitted and their transmission to the supports of the structure. The position of the anchor is indicated on the design drawings.
- The anchorages are designed in accordance with the EOTA TR 054, Edition April 2016, Design method A under the responsibility of an engineer experienced in anchorages and masonry work.

Installation:

- Anchor Installation carried out by appropriately qualified personnel and under the supervision of the person responsible for technical matters of the site.

SCELLEMENT VINYLESTERE FIXH for masonry

Intended use
Specifications

Annex B 1

Table B1: Overview brick types and properties with corresponding fastening elements (Anchors and Sleeves)

Naming Density [kg/dm ³] Dimensions LxBxH [mm]	Picture	Anchor rods	Perforated sleeve	Annex	Naming Density [kg/dm ³] Dimensions LxBxH [mm]	Picture	Anchor rods	Perforated sleeve	Annex
Autoclaved aerated concrete acc. to EN 771-4:2011+A1:2015									
AAC $\rho = 0,35-0,60$ $\geq 499 \times 240 \times 249$		M8 - M16	-	C5 - C10					
Light weight concrete brick acc. to EN 771-3:2011+A1:2015									
VBL $\rho = 0,63$ 240x300x113		M8 - M16	-	C35 - C36	Leca Lex harkko RUH-200 Kulma $\rho = 0,62$ 498x200x195		M8 - M16	12x80 16x85 16x130 20x85 20x130	C39 - C40
Hollow light weight concrete brick acc. to EN 771-3:2011+A1:2015									
Bloc creux B40 $\rho = 0,8$ 494x200x190		M8 - M16	12x80 16x85 16x130 20x85 20x130	C33 - C34	Leca Lex harkko RUH-200 Kulma $\rho = 0,62$ 498x200x195		M8 - M16	12x80 16x85 16x130 20x85 20x130	C37 - C38
Calcium silica bricks acc. to EN 771-2:2011+A1:2015									
KS-NF $\rho = 2,0$ 240x115x71		M8 - M16	12x80 16x85 16x130 20x85 20x130 20x200	C11 - C12	KS L-3DF $\rho = 1,4$ 240x175x113		M8 - M16	12x80 16x85 16x130 20x85 20x130 20x200	C13 - C14
KS L-12DF $\rho = 1,4$ 498x175x238		M8 - M16	12x80 16x85 16x130 20x130	C15 - C16					
SCELLEMENT VINYLESTERE FIXH for masonry							Annex B 2		
Intended use Brick types and properties with corresponding fastening elements									

Table B1: Overview brick types and properties with corresponding fastening elements (Anchors and Sleeves) (Continued)





Naming Density [kg/dm ³] Dimensions LxBxH [mm]	Picture	Anchor rods	Perforated sleeve	Annex	Naming Density [kg/dm ³] Dimensions LxBxH [mm]	Picture	Anchor rods	Perforated sleeve	Annex
Solid clay bricks acc. to EN 771-1:2011+A1:2015									
Mz-1DF ρ = 1,64 240x115x55		M8 - M16	12x80 16x85 16x130 20x85 20x130 20x200	C17 - C18					
Hollow clay bricks acc. to EN 771-1:2011+A1:2015									
HLz-16DF ρ = 0,83 497x240x238		M8 - M16	12x80 16x85 16x130 20x85 20x130 20x200	C19 - C20	Porotherm Homebric ρ = 0,68 500x200x299		M8 - M16	12x80 16x85 16x130 20x85 20x130	C21 - C22
BGV Thermo ρ = 0,62 500x200x314		M8 - M16	12x80 16x85 16x130 20x85 20x130	C23 - C24	Calibric Th ρ = 0,62 500x200x314		M8 - M16	12x80 16x85 16x130 20x85 20x130	C25 - C26
Urbanbrick ρ = 0,74 560x200x274		M8 - M16	12x80 16x85 16x130 20x85 20x130	C27 - C28	Blocchi Leggeri ρ = 0,55 250x120x250		M8 - M16	12x80 16x85 16x130 20x85 20x130 20x200	C29 - C30
Doppio Uni ρ = 0,92 250x120x120		M8 - M16	12x80 16x85 16x130 20x85 20x130 20x200	C31 - C32					
SCELLEMENT VINYLESTERE FIXH for masonry							Annex B 3		
Intended use Brick types and properties with corresponding fastening elements									

Table B2: Installation parameters in Autoclaved Aerated Concrete AAC and solid masonry (without sleeve)

Anchor size			M8	M10	M12	M16
Outer diameter of anchor	$d = d_{nom}$	[mm]	8	10	12	16
Nominal drill hole diameter	d_0	[mm]	10	12	14	18
Drill hole depth	h_0	[mm]	80	90	100	100
Effective anchorage depth	h_{ef}	[mm]	80	90	100	100
Minimum wall thickness	h_{min}	[mm]	$h_{ef} + 30$			
Diameter of clearance hole in the fixture	Prepositioned installation	$d_f \leq$	9	12	14	18
	Push through installation	d_f	12	14	16	20
Maximum torque moment	$\max T_{inst} \leq$	[Nm]	See Annexes C 5 - C 40			
Minimum spacing	s_{min}	[mm]				
Minimum edge distance	c_{min}	[mm]				

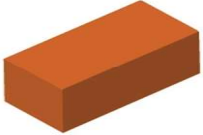
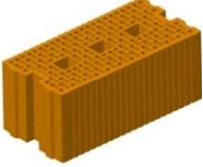
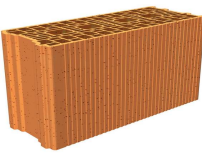
Table B3: Installation parameters in solid and hollow masonry (with sleeve)

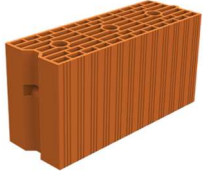

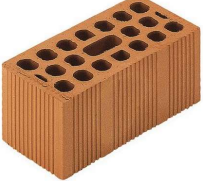

Anchor size			M8	M8 / M10			M12 / M16		
Sleeve BR		[mm]	12x80	16x85	16x130	16x130/330	20x85	20x130	20x200
Outer diameter of anchor	$d_s = d_{nom}$	[mm]	12	16	16	16	20	20	20
Nominal drill hole diameter	d_0	[mm]	12	16	16	16	20	20	20
Drill hole depth	h_0	[mm]	85	90	135	$135 + t_{fix}$	90	135	205
Effective anchorage depth	h_{ef}	[mm]	80	85	130	130	85	130	200
Minimum wall thickness	h_{min}	[mm]	115	115	195	195	115	195	240
Diameter of clearance hole in the fixture	Prepositioned installation	$d_f \leq$	9	9 (M8) / 12 (M10)			14 (M12) / 18 (M16)		
	Push through installation	d_f	14	18			22		
Maximum torque moment	$\max T_{inst} \leq$	[Nm]	See Annexes C 5 - C 40						
Minimum spacing	s_{min}	[mm]							
Minimum edge distance	c_{min}	[mm]							

SCELLEMENT VINYLESTERE FIXH for masonry

Intended use
Installation parameters

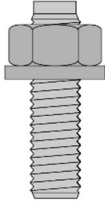
Annex B 4

Table B4: Parameters for cleaning and setting accessories

					
Anchor rod	Perforated sleeve	d_0 Drill bit - \varnothing HD, CA	d_b Brush - \varnothing		$d_{b,min}$ min. Brush - \varnothing
[mm]		[mm]		[mm]	[mm]
Autoclaved Aerated Concrete ACC and solid masonry (without sleeve)					
M8	-	10	SC10	12	10,5
M10	-	12	SC12	14	12,5
M12	-	14	SC16	18	16,5
M16	-	18	SC18	20	18,5
Solid and hollow masonry (with sleeve)					
M8	BR 12x80	12	SC12	14	12,5
M8 / M10	BR 16x85	16	SC16	18	16,5
	BR 16x130				
	BR 16x130/330				
M12 / M16	BR 20x85	20	SC20	22	20,5
	BR 20x130				
	BR 20x200				

Cleaning and installation tools

Hand pump



Compressed air tool



Brush SC



Brush extension SL



SCELLEMENT VINYLESTERE FIXH for masonry

Intended use
Cleaning and installation accessories

Annex B 5

Table B5: Working and curing time

Temperature in base material	Maximum working time	Minimum curing time
T	t_{work}	t_{cure}
- 5 °C to - 1 °C	90 min	6 h
+ 0 °C to + 4 °C	45 min	3 h
+ 5 °C to + 9 °C	25 min	2 h
+ 10 °C to + 14 °C	20 min	100 min
+ 15 °C to + 19 °C	15 min	80 min
+ 20 °C to + 29 °C	6 min	45 min
+ 30 °C to + 34 °C	4 min	25 min
+ 35 °C to + 39 °C	2 min	20 min
Cartridge temperature	+5°C up to +40°C	

SCELLEMENT VINYLESTERE FIXH for masonry**Intended use**
Working and curing time**Annex B 6**

Installation instructions

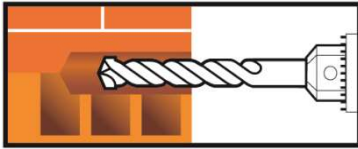

1. Drill a hole to the required embedment depth with drilling method according to Annex C 5 - C 40.
Drill bit diameter according to Table B4.

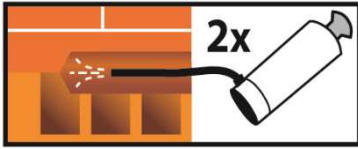

- 2a. Blow the bore hole clean minimum 2x from the bottom or back by hand pump or compressed air tool (Annex B 5).

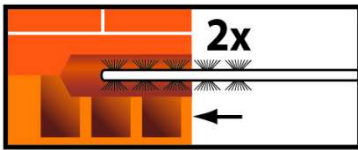

- 2b. Attach the brush SC according to Table B4 to a drilling machine or a cordless screwdriver.
Brush the bore hole minimum 2x with brush over the entire embedment depth in a twisting motion (if necessary, use a brush extension SL).

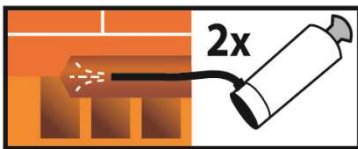

- 2c. Finally blow the bore hole clean minimum 2x from the bottom or back by hand pump or compressed air tool (Annex B 5).

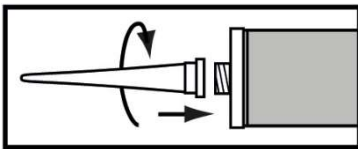

3. Screw on static-mixing nozzle M17, and load the cartridge into an appropriate dispensing tool.
If necessary, cut off the foil tube clip before use.
For every working interruption longer than the maximum working time t_{work} (Annex B 6) as well as for new cartridges, a new static-mixer shall be used.

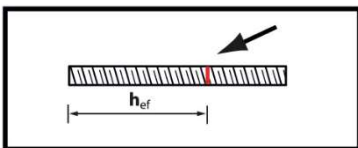

4. Mark embedment depth on the anchor rod.
The anchor rod shall be free of dirt, grease, oil or other foreign material.

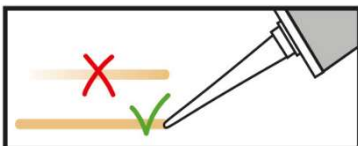

5. Not proper mixed mortar is not sufficient for fastening.
Dispense and discard mortar until an uniform grey colour is shown (at least 3 full strokes; for foil tube cartridges at least 6 full strokes).

SCELLEMENT VINYLESTERE FIXH for masonry

Intended use
Installation instruction

Annex B 7

Installation instructions (continuation)

Installation without sleeve

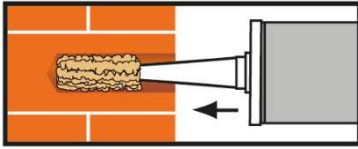

6. Starting at bottom of the hole and fill the hole up to approximately two-thirds with adhesive. (If necessary, a mixer nozzle extension shall be used.) Slowly withdraw of the static mixing nozzle avoid creating air pockets. Observe the temperature related working time t_{work} (Annex B 6).

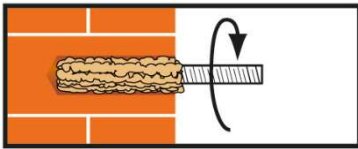

7. Insert the anchor rod while turning slightly up to the embedment mark.

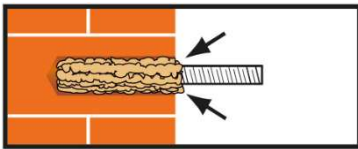

8. Annular gap between anchor rod and base material must be completely filled with mortar. For push through installation the annular gap between anchor rod and fixture must be filled with mortar. Otherwise, the installation must be repeated starting from step 6 before the maximum working time t_{work} has expired.

Installation with sleeve

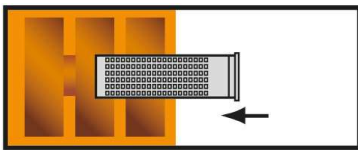

6. Insert the perforated sleeve flush with the surface of the masonry. Only use sleeves that have the right length. Never cut the sleeve in anchoring area (h_{ef}). For installation through insulation, the sleeve BR 16x130/330 can be cutted at the top end according to the insulation thickness.

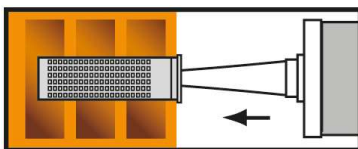

7. Starting from the bottom or back fill the sleeve with adhesive. (If necessary, a mixer nozzle extension shall be used.) Refer to the cartridge label or the technical data sheet for the exact amount of mortar. For push through installation the sleeve within the fixture must also be fully filled with mortar. Observe the temperature related working time t_{work} (Annex B 6).

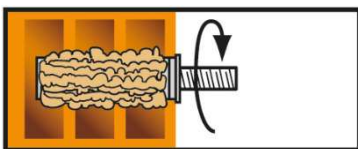

8. Insert the anchor rod with a slight twist up to the mark.

SCELLEMENT VINYLESTERE FIXH for masonry

Intended use
Installation instruction (continuation)

Annex B 8

Installation instructions (continuation)



9. Temperature related curing time t_{cure} (Annex B 6) must be observed. Do not move or load the fastener during curing time.

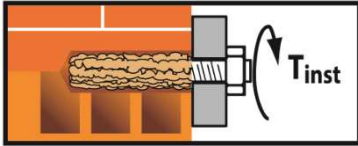

10. Install the fixture by using a calibrated torque wrench. Observe maximum installation torque according to Annex C 5 – C 40.

SCELLEMENT VINYLESTERE FIXH for masonry

Intended use
Installation instruction (continuation)

Annex B 9

Table C1: β -factors for job-site testing under tension loading

Brick	Installation & Use conditions	Anchor size	β -factor	
			T _a : 24°C / 40°C	T _b : 50°C / 80°C
AAC Annex C 5 to Annex C 10	d/d	M8	0,82	0,70
		M10		
		M12	0,70	0,60
		M16		
	w/w	M8	0,82	0,70
		M10	0,63	0,54
		M12	0,48	0,41
		M16		
All bricks Annex C 11 to Annex C 40	d/d w/d w/w	For all anchors	0,72	0,50

SCELLEMENT VINYLESTERE FIXH for masonry

Performances
 β -factors for job site testing under tension load

Annex C 1

Table C2: Characteristic tension, shear resistance and bending moment of threaded rod

Threaded rod			M8	M10	M12	M16	
Cross section area	A_s	[mm ²]	36,6	58	84,3	157	
Characteristic tension resistance, Steel failure 1)							
Steel, Property class 4.6 and 4.8	$N_{RK,s}$	[kN]	15 (13)	23 (21)	34	63	
Steel, Property class 5.6 and 5.8	$N_{RK,s}$	[kN]	18 (17)	29 (27)	42	78	
Steel, Property class 8.8	$N_{RK,s}$	[kN]	29 (27)	46 (43)	67	125	
Stainless steel A2, A4 and HCR, class 50	$N_{RK,s}$	[kN]	18	29	42	79	
Stainless steel A2, A4 and HCR, class 70	$N_{RK,s}$	[kN]	26	41	59	110	
Stainless steel A4 and HCR, class 80	$N_{RK,s}$	[kN]	29	46	67	126	
Characteristic tension resistance, Partial factor 2)							
Steel, Property class 4.6 and 5.6	$\gamma_{Ms,N}$	[-]	2,0				
Steel, Property class 4.8, 5.8 and 8.8	$\gamma_{Ms,N}$	[-]	1,5				
Stainless steel A2, A4 and HCR, class 50	$\gamma_{Ms,N}$	[-]	2,86				
Stainless steel A2, A4 and HCR, class 70	$\gamma_{Ms,N}$	[-]	1,87				
Stainless steel A4 and HCR, class 80	$\gamma_{Ms,N}$	[-]	1,6				
Characteristic shear resistance, Steel failure 1)							
Without lever arm	Steel, Property class 4.6 and 4.8	$V_{RK,s}^0$	[kN]	7 (7)	12 (11)	17	31
	Steel, Property class 5.6 and 5.8	$V_{RK,s}^0$	[kN]	9 (8)	15 (13)	21	39
	Steel, Property class 8.8	$V_{RK,s}^0$	[kN]	15 (13)	23 (21)	34	63
	Stainless steel A2, A4 and HCR, class 50	$V_{RK,s}^0$	[kN]	9	15	21	39
	Stainless steel A2, A4 and HCR, class 70	$V_{RK,s}^0$	[kN]	13	20	30	55
	Stainless steel A4 and HCR, class 80	$V_{RK,s}^0$	[kN]	15	23	34	63
With lever arm	Steel, Property class 4.6 and 4.8	$M_{RK,s}^0$	[Nm]	15 (13)	30 (27)	52	133
	Steel, Property class 5.6 and 5.8	$M_{RK,s}^0$	[Nm]	19 (16)	37 (33)	65	166
	Steel, Property class 8.8	$M_{RK,s}^0$	[Nm]	30 (26)	60 (53)	105	266
	Stainless steel A2, A4 and HCR, class 50	$M_{RK,s}^0$	[Nm]	19	37	66	167
	Stainless steel A2, A4 and HCR, class 70	$M_{RK,s}^0$	[Nm]	26	52	92	232
	Stainless steel A4 and HCR, class 80	$M_{RK,s}^0$	[Nm]	30	59	105	266
Characteristic shear resistance, Partial factor 2)							
Steel, Property class 4.6 and 5.6	$\gamma_{Ms,V}$	[-]	1,67				
Steel, Property class 4.8, 5.8 and 8.8	$\gamma_{Ms,V}$	[-]	1,25				
Stainless steel A2, A4 and HCR, class 50	$\gamma_{Ms,V}$	[-]	2,38				
Stainless steel A2, A4 and HCR, class 70	$\gamma_{Ms,V}$	[-]	1,56				
Stainless steel A4 and HCR, class 80	$\gamma_{Ms,V}$	[-]	1,33				

1) Values are only valid for the given stress area A_s . Values in brackets are valid for undersized threaded rods with smaller stress area A_s for hot-dip galvanised threaded rods according to EN ISO 10684:2004+AC:2009.

2) in absence of national regulation

SCELLEMENT VINYLESTERE FIXH for masonry

Performances

Characteristic tension, shear resistance and bending moment of threaded rod

Annex C 2

Spacing and edge distances

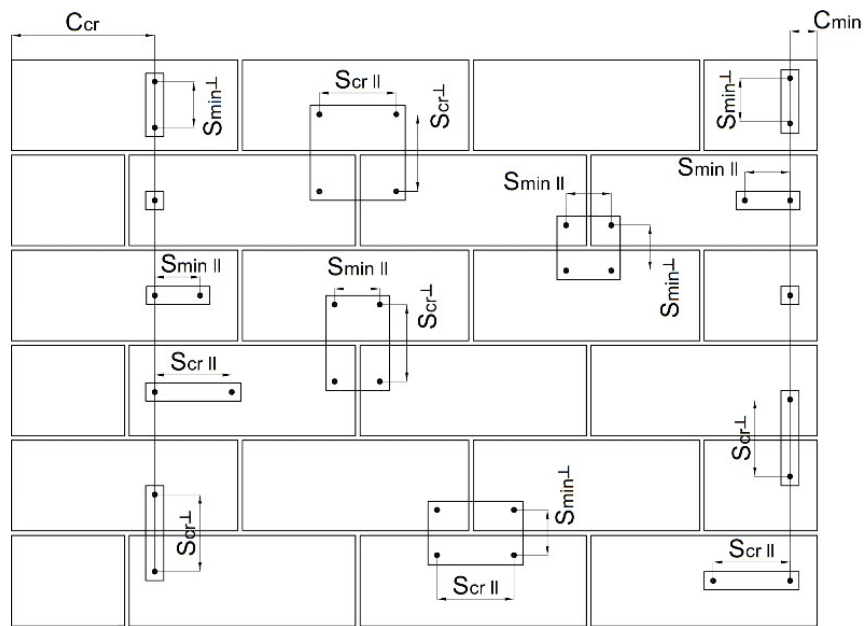

- C_{cr} = Characteristic edge distance
- C_{min} = Minimum edge distance
- $S_{scr II}; (S_{min II})$ = Characteristic (minimum) spacing for anchors placed parallel to horizontal joint
- $S_{scr \perp}; (S_{min \perp})$ = Characteristic (minimum) spacing for anchors placed perpendicular to horizontal joint

Anchor position	Load direction				
	Tension load	Shear load parallel to free edge V_{II}	Shear load perpendicular to free edge V_{\perp}		
Anchors parallel to horizontal joint $S_{scr II}; (S_{min II})$			$\alpha_{g II, VII}$		$\alpha_{g II, V\perp}$
Anchors vertical to horizontal joint $S_{scr \perp}; (S_{min \perp})$			$\alpha_{g \perp, VII}$		$\alpha_{g \perp, V\perp}$

- $\alpha_{g II, N}$ = Group factor for anchors parallel to horizontal joint under tension load
- $\alpha_{g \perp, N}$ = Group factor for anchors perpendicular to horizontal joint under tension load
- $\alpha_{g II, VII}$ = Group factor for anchors parallel to horizontal joint under shear load parallel to the free edge
- $\alpha_{g \perp, VII}$ = Group factor for anchors perpendicular to horizontal joint under shear load parallel to the free edge
- $\alpha_{g II, V\perp}$ = Group factor for anchors parallel to horizontal joint under shear load perpendicular to the free edge
- $\alpha_{g \perp, V\perp}$ = Group factor for anchors perpendicular to hor. joint under shear load perpendicular to the free edge

Group of 2 anchors: $N_{Rk}^{g,N} = \alpha_{g,N} * N_{Rk,b}$
 $V_{Rk}^{g,V} = \alpha_{g,V} * V_{Rk,b}$

Group of 4 anchors: $N_{Rk}^{g,II,N} = \alpha_{g II, N} * \alpha_{g \perp, N} * N_{Rk,b}$
 $V_{Rk}^{g,II,V} = \alpha_{g II, V} * \alpha_{g \perp, V} * V_{Rk,b}$

Equations depend on anchor position and load direction (see table above).

SCELLEMENT VINYLESTERE FIXH for masonry

Performances
Edge distance and anchor spacing

Annex C 3

Group factor, valid for all brick types						
Group factor for anchor group in case of tension loading						
Configuration		with $c \geq$	with $s \geq$			
II: anchors placed parallel to horizontal joint		C_{cr}	S_{cr}	$\alpha_{g II, N}$	[-]	2,0
I: anchors placed perpendicular to horizontal joint		C_{cr}	S_{cr}	$\alpha_{g \perp, N}$		2,0
Group factor for anchor group in case of shear loading parallel to free edge						
Configuration		with $c \geq$	with $s \geq$			
II: anchors placed parallel to horizontal joint		C_{cr}	S_{cr}	$\alpha_{g II, VII}$	[-]	2,0
I: anchors placed perpendicular to horizontal joint		C_{cr}	S_{cr}	$\alpha_{g \perp, VII}$		2,0
Group factor for anchor group in case of shear loading perpendicular to free edge						
Configuration		with $c \geq$	with $s \geq$			
II: anchors placed parallel to horizontal joint		C_{cr}	S_{cr}	$\alpha_{g II, VI \perp}$	[-]	2,0
I: anchors placed perpendicular to horizontal joint		C_{cr}	S_{cr}	$\alpha_{g \perp, VI \perp}$		2,0
SCELLEMENT VINYLESTERE FIXH for masonry				Annex C 4		
Performances Group factor						

Brick type: Autoclaved Aerated Concrete – AAC2

Table C3: Description

Brick type	Autoclaved Aerated Concrete AAC2	
Bulk density [kg/dm ³]	0,35	
Compressive strength [N/mm ²]	2	
Code	EN 771-4	
Producer (country code)	e.g. Ytong (CZ)	
Brick dimensions [mm]	599 x 375 x 249	
Drilling method	Rotary drilling	

Table C4: Installation parameter (Edge and spacing distances)

Anchor size	Effective anchorage depth	Edge distance	Spacing	Maximum installation torque
	h_{ef}	$c_{min} = c_{cr}$	$s_{cr} = s_{min \parallel} = s_{min \perp}$	$\max T_{inst}$
		[mm]		[Nm]
M8	80	120	240	2
M10	90	135	270	
M12	100	150	300	
M16	100	150	300	

Table C5: Displacement

h_{ef}	N	δ_{N0}	$\delta_{N\infty}$	V	δ_{V0}	$\delta_{V\infty}$
[mm]	[kN]	[mm]	[mm]	[kN]	[mm]	[mm]
80	$\frac{N_{Rk}}{1,4 \cdot \gamma_M}$	0,29	0,58	$\frac{V_{Rk}}{1,4 \cdot \gamma_M}$	1,23	1,84
90		0,23	0,46		0,87	1,31
100		0,39	0,79		1,29	1,94

SCELLEMENT VINYLESTERE FIXH for masonry

Performance Autoclaved Aerated Concrete – AAC2

Brick description

Installation parameters, Displacements

Annex C 5

Brick type: Autoclaved Aerated Concrete – AAC2

Table C6: Characteristic values of resistance under tension and shear loads

Anchor size	Effective anchorage depth	Characteristic resistance				
		Use category				
		d/d		w/d w/w		d/d w/d w/w
		40°C / 24°C	80°C / 50°C	40°C / 24°C	80°C / 50°C	For all temperature range
		$N_{Rk}^{1)}$	$N_{Rk}^{1)}$	$N_{Rk}^{1)}$	$N_{Rk}^{1)}$	$V_{Rk,b}^{2)}$
h_{ef}	[kN]					
[mm]						
Compressive strength $f_b \geq 2 \text{ N/mm}^2$						
M8	80	0,9	0,9	0,9	0,9	1,5
M10	90	0,9	0,9	0,9	0,75	2,0
M12	100	1,5	1,5	1,2	0,9	2,5
M16	100	1,5	1,5	1,2	0,9	3,5

¹⁾ For design according TR 054: $N_{Rk} = N_{Rk,p} = N_{Rk,b}$; $N_{Rk,s}$ according to Table C2 Annex C2; Calculation $N_{Rk,pb}$ see TR 054

²⁾ For $V_{Rk,s}$ see Annex C 2, Table C2; Calculation of $V_{Rk,pb}$ and $V_{Rk,c}$ see TR 054

SCELLEMENT VINYLESTERE FIXH for masonry

Performance Autoclaved Aerated Concrete – AAC2
Characteristic values of resistance under tension and shear load

Annex C 6

Brick type: Autoclaved Aerated Concrete AAC4

Table C7: Description

Brick type	Autoclaved Aerated Concrete AAC4	
Bulk density [kg/dm ³]	0,50	
Compressive strength [N/mm ²]	4	
Code	EN 771-4	
Producer (country code)	e.g. Ytong (CZ)	
Brick dimensions [mm]	499 x 375 x 249	
Drilling method	Rotary drilling	

Table C8: Installation parameter (Edge and spacing distances)

Anchor size	Effective anchorage depth	Edge distance	Spacing	Maximum installation torque
	h_{ef}	$c_{min} = c_{cr}$	$s_{cr} = s_{min \parallel} = s_{min \perp}$	$\max T_{inst}$
		[mm]		[Nm]
M8	80	120	240	2
M10	90	135	270	
M12	100	150	300	
M16	100	150	300	

Table C9: Displacement

h_{ef}	N	δ_{N0}	$\delta_{N\infty}$	V	δ_{V0}	$\delta_{V\infty}$
[mm]	[kN]	[mm]	[mm]	[kN]	[mm]	[mm]
80	$\frac{N_{Rk}}{1,4 \cdot \gamma_M}$	0,23	0,47	$\frac{V_{Rk}}{1,4 \cdot \gamma_M}$	1,23	1,84
90		0,58	1,17		0,87	1,31
100		0,10	0,21		1,29	1,94

SCELLEMENT VINYLESTERE FIXH for masonry

Performance Autoclaved Aerated Concrete – AAC4

Brick description

Installation parameters, Displacement

Annex C 7

Brick type: Autoclaved Aerated Concrete AAC4

Table C10: Characteristic values of resistance under tension and shear loads

Anchor size	Effective anchorage depth	Characteristic resistance				
		Use category				
		d/d		w/d w/w		d/d w/d w/w
		40°C / 24°C	80°C / 50°C	40°C / 24°C	80°C / 50°C	For all temperature range
		$N_{Rk}^{1)}$	$N_{Rk}^{1)}$	$N_{Rk}^{1)}$	$N_{Rk}^{1)}$	$V_{Rk,b}^{2)}$
h_{ef}	[kN]					
[mm]						
Compressive strength $f_b \geq 4 \text{ N/mm}^2$						
M8	80	0,9	0,9	0,9	0,9	1,5
M10	90	2,5	2,0	1,5	1,5	2,0
M12	100	2,5	2,0	2,0	1,5	2,5
M16	100	3,5	3,0	2,0	2,0	3,5

¹⁾ For design according TR 054: $N_{Rk} = N_{Rk,p} = N_{Rk,b}$; $N_{Rk,s}$ according to Table C2 Annex C2; Calculation $N_{Rk,pt}$ see TR 054

²⁾ For $V_{Rk,s}$ see Annex C 2, Table C2; Calculation of $V_{Rk,pt}$ and $V_{Rk,c}$ see TR 054

SCELLEMENT VINYLESTERE FIXH for masonry

Performance Autoclaved Aerated Concrete – AAC4
Characteristic values of resistance under tension and shear load

Annex C 8

Brick type: Autoclaved Aerated Concrete AAC6

Table C11: Description

Brick type	Autoclaved Aerated Concrete AAC6	
Bulk density [kg/dm ³]	0,60	
Compressive strength [N/mm ²]	6	
Code	EN 771-4	
Producer (country code)	e.g. Porit (DE)	
Brick dimensions [mm]	499 x 240 x 249	
Drilling method	Rotary drilling	

Table C12: Installation parameter (Edge and spacing distances)

Anchor size	Effective anchorage depth	Edge distance	Spacing	Maximum installation torque
	h_{ef}	$c_{min} = c_{cr}$	$s_{cr} = s_{min \parallel} = s_{min \perp}$	$\max T_{inst}$
		[mm]		[Nm]
M8	80	120	240	2
M10	90	135	270	
M12	100	150	300	
M16	100	150	300	

Table C13: Displacement

h_{ef}	N	δ_{N0}	$\delta_{N\infty}$	V	δ_{V0}	$\delta_{V\infty}$
[mm]	[kN]	[mm]	[mm]	[kN]	[mm]	[mm]
80	$\frac{N_{Rk}}{1,4 \cdot \gamma_M}$	0,54	1,09	$\frac{V_{Rk}}{1,4 \cdot \gamma_M}$	0,32	0,48
90		0,85	1,69		1,49	2,23
100		0,10	0,19		1,67	2,50

SCELLEMENT VINYLESTERE FIXH for masonry

Performance Autoclaved Aerated Concrete – AAC6

Brick description

Installation parameters, Displacements

Annex C 9

Brick type: Autoclaved Aerated Concrete AAC6

Table C14: Characteristic values of resistance under tension and shear loads

Anchor size	Effective anchorage depth	Characteristic resistance				
		Use category				
		d/d		w/d w/w		d/d w/d w/w
		40°C / 24°C	80°C / 50°C	40°C / 24°C	80°C / 50°C	For all temperature range
		$N_{Rk}^{1)}$	$N_{Rk}^{1)}$	$N_{Rk}^{1)}$	$N_{Rk}^{1)}$	$V_{Rk,b}^{2)}$
h_{ef}	[kN]					
[mm]						
Compressive strength $f_b \geq 6 \text{ N/mm}^2$						
M8	80	2,0	2,0	2,0	2,0	5,5
M10	90	3,0	2,5	2,5	2,0	9,0
M12	100	4,5	3,5	3,0	2,5	9,0
M16	100	5,5	4,5	3,5	3,0	11,0

¹⁾ For design according TR 054: $N_{Rk} = N_{Rk,p} = N_{Rk,b}$; $N_{Rk,s}$ according to Table C2 Annex C2; Calculation $N_{Rk,pt}$ see TR 054

²⁾ For $V_{Rk,s}$ see Annex C 2, Table C2; Calculation of $V_{Rk,pt}$ and $V_{Rk,c}$ see TR 054

SCELLEMENT VINYLESTERE FIXH for masonry

Performance Autoclaved Aerated Concrete – AAC6
Characteristic values of resistance under tension and shear load

Annex C 10

Brick type: Calcium silicate solid brick KS-NF

Table C15: Description

Brick type	Calcium silicate solid brick KS-NF	
Bulk density [kg/dm ³]	2,0	
Compressive strength [N/mm ²]	10, 20 or 27	
Code	EN 771-2	
Producer (country code)	e.g. Wemding (DE)	
Brick dimensions [mm]	240 x 115 x 71	
Drilling method	Hammer drilling	

Table C16: Installation parameter (Edge and spacing distances)

Anchor size	Sleeve	Embedment depth	Edge distance	Spacing	Maximum installation torque
		h_{ef}	$c_{min} = c_{cr}$	$s_{cr} = s_{min \parallel} = s_{min \perp}$	max T_{inst}
		[mm]			[Nm]
M8	-	80	120	240	10
M10	-	90	135	270	20
M12 / M16	-	100	150	300	
M8	BR 12x80	80	120	240	10
	BR 16x85	85	127	255	
M10	BR 16x85	85	127	255	20
M8 / M10	BR 16x130	130	195	390	
	BR 16x130/330	130	195	390	
M12 / M16	BR 20x85	85	127	255	
	BR 20x130	130	195	390	
	BR 20x200	200	300	600	

Table C17: Displacement

h_{ef}	N	δ_{N0}	$\delta_{N\infty}$	V	δ_{V0}	$\delta_{V\infty}$
[mm]	[kN]	[mm]	[mm]	[kN]	[mm]	[mm]
80	$\frac{N_{Rk}}{1,4 \cdot \gamma_M}$	0,08	0,16	$\frac{V_{Rk}}{1,4 \cdot \gamma_M}$	3,07	4,61
85		0,26	0,52		1,46	2,19
90		0,09	0,18		1,50	2,25
100		0,10	0,20		1,03	1,53
130 ; 200		0,22	0,44		1,16	1,74

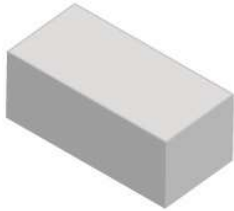
SCELLEMENT VINYLESTERE FIXH for masonry

Performance Calcium solid brick KS-NF

Brick description
Installation parameters, Displacements

Annex C 11

Brick type: Calcium silicate solid brick KS-NF

Table C18: Characteristic values of resistance under tension and shear loads

Anchor size	Sleeve	Effective anchorage depth	Characteristic resistance		
			Use category		
			d/d w/d w/w		
			40°C / 24°C	80°C / 50°C	For all temperature range
h _{ef}	N _{Rk} ¹⁾	N _{Rk} ¹⁾	V _{Rk,b} ²⁾		
[mm]	[kN]				
Compressive strength $f_b \geq 10 \text{ N/mm}^2$					
M8	-	80	3,0	2,0	3,0
M10	-	90	3,0	2,0	3,0
M12	-	100	4,0	2,5	3,5
M16	-	100	3,0	2,0	3,5
M8	BR 12x80	80	2,5	2,0	2,5
	BR 16x85	85	2,5	2,0	3,0
	BR16x130 / BR16x130/330	130	4,0	2,5	4,0
M10	BR 16x85	85	2,5	2,0	3,0
	BR16x130/330	130	4,5	3,0	4,0
M12 / M16	BR 20x85	85	2,5	2,0	3,0
	BR 20x130 / BR 20x200	130 / 200	4,5	2,5	4,0
Compressive strength $f_b \geq 20 \text{ N/mm}^2$					
M8	-	80	4,5	3,0	4,5
M10	-	90	4,5	3,0	4,5
M12	-	100	5,5	3,5	5,0
M16	-	100	4,5	3,0	5,0
M8	BR 12x80	80	4,0	2,5	4,0
	BR 16x85	85	4,0	2,5	4,5
	BR16x130 / BR16x130/330	130	6,0	3,5	5,5
M10	BR 16x85	85	4,0	2,5	4,5
	BR 16x130/330	130	6,0	4,0	5,5
M12 / M16	BR 20x85	85	4,0	2,5	5,0
	BR 20x130 / BR 20x200	130 / 200	6,0	4,0	5,5
Compressive strength $f_b \geq 27 \text{ N/mm}^2$					
M8	-	80	5,5	3,5	5,0
M10	-	90	5,5	3,5	5,5
M12	-	100	6,5	4,5	6,0
M16	-	100	5,5	3,5	6,0
M8	BR 12x80	80	4,5	3,0	4,5
	BR 16x85	85	4,5	3,0	5,5
	BR16x130 / BR16x130/330	130	6,5	4,5	6,5
M10	BR 16x85	85	4,5	3,0	5,5
	BR 16x130/330	130	6,5	4,5	6,5
M12 / M16	BR 20x85	85	4,5	3,0	5,5
	BR 20x130 / BR 20x200	130 / 200	6,5	4,5	6,5

1) For design according TR 054: $N_{Rk} = N_{Rk,p} = N_{Rk,b}$; $N_{Rk,s}$ according to Table C2 Annex C2; Calculation $N_{Rk,pb}$ see TR 054

2) For $V_{Rk,s}$ see Annex C 2, Table C2; Calculation of $V_{Rk,pb}$ and $V_{Rk,c}$ see TR 054

SCELLEMENT VINYLESTERE FIXH for masonry

Performance Calcium solid brick KS-NF

Characteristic values of resistance under tension and shear load

Annex C 12

Brick type: Calcium silicate hollow brick KS L-3DF

Table C19: Description

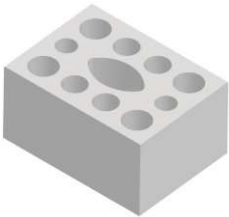
Brick type	Calcium silicate hollow brick KS L-3DF	
Bulk density [kg/dm ³]	1,4	
Compressive strength [N/mm ²]	8, 12 or 14	
Code	EN 771-2	
Producer (country code)	e.g. Wemding (DE)	
Brick dimensions [mm]	240 x 175 x 113	
Drilling method	Rotary drilling	

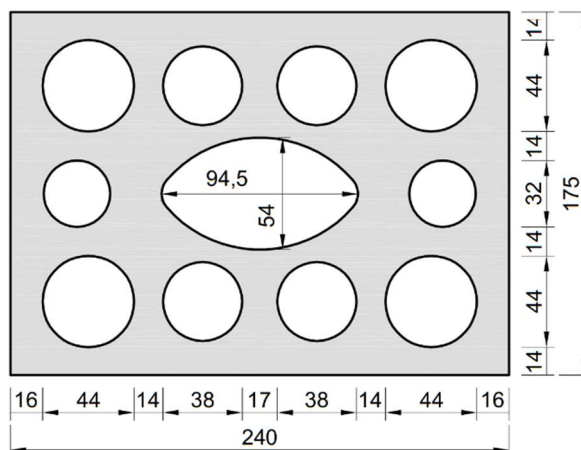

Table C20: Installation parameter (Edge and spacing distances)

Anchor size	Sleeve	Embedment depth	Edge distance	Spacing		Maximum installation torque
				$S_{cr} = S_{min II}$	$S_{min \perp}$	
		h_{ef}	$C_{min} = C_{cr}$	[mm]		$\max T_{inst}$
						[Nm]
M8	BR 12x80	80	100	240	113	8
M8 / M10	BR 16x85	85				
	BR 16x130	130				
	BR 16x130/330	130				
M12 / M16	BR 20x85	85	120	240	113	8
	BR 20x130	130				
	BR 20x200	200				

Table C21: Displacement

h_{ef}	N	δ_{N0}	$\delta_{N\infty}$	V	δ_{V0}	$\delta_{V\infty}$
[mm]	[kN]	[mm]	[mm]	[kN]	[mm]	[mm]
80	$\frac{N_{Rk}}$	0,36	0,73	$\frac{V_{Rk}}$	0,82	1,23
85		1,62	3,24		1,83	2,75
130 ; 200	$1,4 \bullet \gamma_M$	1,70	3,40	$1,4 \bullet \gamma_M$	1,98	2,98

SCELLEMENT VINYLESTERE FIXH for masonry

Performance Calcium hollow brick KS L-3DF

Brick description
Installation parameters, Displacements

Annex C 13

Brick type: Calcium silicate hollow brick KS L-3DF

Table C22: Characteristic values of resistance under tension and shear loads

Anchor size	Sleeve	Effective anchorage depth	Characteristic resistance		
			Use category		
			d/d w/d w/w		
			40°C / 24°C	80°C / 50°C	For all temperature range
h_{ef}	$N_{Rk}^{1)}$	$N_{Rk}^{1)}$	$V_{Rk,b}^{2)}$		
	[mm]	[kN]			
Compressive strength $f_b \geq 8 \text{ N/mm}^2$					
M8	BR 12x80	80	1,5	0,9	2,0
	BR 16x85	85	1,5	0,9	2,5
	BR 16x130	130	2,5	1,5	3,0
	BR 16x130/330	130	2,5	1,5	3,0
M10	BR 16x85	85	1,5	0,9	2,5
	BR 16x130	130	2,5	1,5	3,0
	BR 16x130/330	130	2,5	1,5	3,0
M12	BR 20x85	85	1,5	0,9	3,0
	BR 20x130 / BR 20x200	130 / 200	2,5	1,5	3,0
M16	BR 20x85	85	1,5	0,9	3,0
	BR 20x130 / BR 20x200	130 / 200	2,5	1,5	4,0
Compressive strength $f_b \geq 12 \text{ N/mm}^2$					
M8	BR 12x80	80	2,0	1,2	2,5
	BR 16x85	85	2,0	1,2	3,5
	BR 16x130	130	3,5	2,0	4,5
	BR 16x130/330	130	3,5	2,0	4,5
M10	BR 16x85	85	2,0	1,2	3,5
	BR 16x130	130	3,5	2,0	4,5
	BR 16x130/330	130	3,5	2,0	4,5
M12	BR 20x85	85	2,0	1,2	3,5
	BR 20x130 / BR 20x200	130 / 200	3,5	2,0	4,5
M16	BR 20x85	85	2,0	1,2	3,5
	BR 20x130 / BR 20x200	130 / 200	3,5	2,0	5,0
Compressive strength $f_b \geq 14 \text{ N/mm}^2$					
M8	BR 12x80	80	2,5	1,5	3,0
	BR 16x85	85	2,5	1,5	4,0
	BR 16x130	130	4,0	3,0	5,0
	BR 16x130/330	130	4,0	3,0	5,0
M10	BR 16x85	85	2,5	1,5	4,0
	BR 16x130	130	4,0	3,0	5,0
	BR 16x130/330	130	4,0	3,0	5,0
M12	BR 20x85	85	2,5	1,5	4,5
	BR 20x130 / BR 20x200	130 / 200	4,0	3,0	5,0
M16	BR 20x85	85	2,5	1,5	4,5
	BR 20x130 / BR 20x200	130 / 200	4,0	3,0	6,0

¹⁾ For design according TR 054: $N_{Rk} = N_{Rk,p} = N_{Rk,b}$; $N_{Rk,s}$ according to Table C2 Annex C2; Calculation $N_{Rk,pb}$ see TR 054

²⁾ For $V_{Rk,s}$ see Annex C 2, Table C2; Calculation of $V_{Rk,pb}$ and $V_{Rk,c}$ see TR 054

SCELLEMENT VINYLESTERE FIXH for masonry

Performance Calcium hollow brick KS L-3DF

Characteristic values of resistance under tension and shear load

Annex C 14

Brick type: Calcium silicate hollow brick KS L-12DF

Table C23: Description

Brick type	Calcium silicate hollow brick KS L-12DF	
Bulk density [kg/dm ³]	1,40	
Compressive strength [N/mm ²]	10, 12 or 16	
Code	EN 771-2	
Producer (country code)	e.g. Wemding (DE)	
Brick dimensions [mm]	498 x 175 x 238	
Drilling method	Rotary drilling	

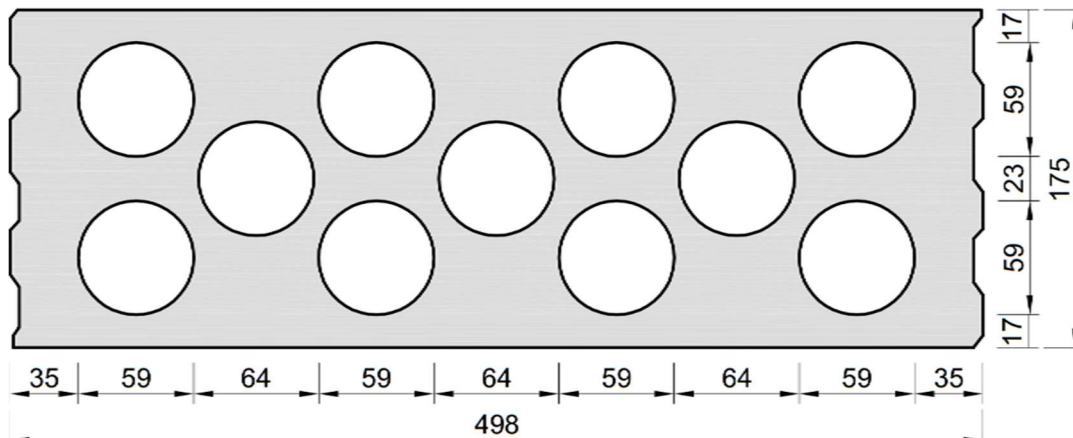

Table C24: Installation parameter (Edge and spacing distances)

Anchor size	Sleeve	Embedment depth h_{ef}	Edge distance $c_{min} = c_{cr}$	Spacing		Maximum installation torque $\max T_{inst}$
				$s_{cr} = s_{min \parallel}$	$s_{min \perp}$	
				[mm]		[Nm]
M8	BR 12x80	80	100	498	238	2
M8 / M10	BR 16x85	85				4
	BR 16x130	130				
	BR 16x130/330	130				
M12 / M16	BR 20x85	85	120	498	238	4
	BR 20x130	130				

Table C25: Displacement

h_{ef}	N	δ_{N0}	$\delta_{N\infty}$	V	δ_{V0}	$\delta_{V\infty}$
[mm]	[kN]	[mm]	[mm]	[kN]	[mm]	[mm]
80	$\frac{N_{Rk}}{1,4 \cdot \gamma_M}$	0,21	0,42	$\frac{V_{Rk}}{1,4 \cdot \gamma_M}$	1,77	2,66
85		0,13	0,26		3,89	5,83
130		0,22	0,44		4,35	6,52

SCELLEMENT VINYLESTERE FIXH for masonry

Performance Calcium hollow brick KS L-12DF

Brick description
Installation parameters, Displacement

Annex C 15

Brick type: Calcium silicate hollow brick KS L-12DF

Table C26: Characteristic values of resistance under tension and shear loads

Anchor size	Sleeve	Effective anchorage depth	Characteristic resistance		
			Use category		
			d/d	w/d	w/w
			40°C / 24°C	80°C / 50°C	For all temperature range
h_{ef}	$N_{Rk}^{1)}$	$N_{Rk}^{1)}$	$V_{Rk,b}^{2)}$		
[mm]	[kN]				
Compressive strength $f_b \geq 10 \text{ N/mm}^2$					
M8	BR 12x80	80	0,4	0,3	3,0
	BR 16x85	85	1,2	0,9	6,0
	BR 16x130	130	3,5	2,5	7,0
	BR 16x130/330	130	3,5	2,5	7,0
M10	BR 16x85	85	1,2	0,9	6,0
	BR 16x130	130	3,5	2,5	7,0
	BR 16x130/330	130	3,5	2,5	7,0
M12 / M16	BR 20x85	85	1,2	0,9	6,0
	BR 20x130 / BR 20x200	130 / 200	3,5	2,5	7,0
Compressive strength $f_b \geq 12 \text{ N/mm}^2$					
M8	BR 12x80	80	0,4	0,3	3,5
	BR 16x85	85	1,5	0,9	7,0
	BR 16x130	130	4,5	3,0	8,0
	BR 16x130/330	130	4,5	3,0	8,0
M10	BR 16x85	85	1,5	0,9	7,0
	BR 16x130	130	4,5	3,0	8,0
	BR 16x130/330	130	4,5	3,0	8,0
M12 / M16	BR 20x85	85	1,5	0,9	7,0
	BR 20x130 / BR 20x200	130 / 200	4,5	3,0	8,0
Compressive strength $f_b \geq 16 \text{ N/mm}^2$					
M8	BR 12x80	80	0,5	0,4	4,0
	BR 16x85	85	2,0	1,2	9,0
	BR 16x130	130	5,5	3,5	10,0
	BR 16x130/330	130	5,5	3,5	10,0
M10	BR 16x85	85	2,0	1,2	9,0
	BR 16x130	130	5,5	3,5	10,0
	BR 16x130/330	130	5,5	3,5	10,0
M12 / M16	BR 20x85	85	2,0	1,2	8,5
	BR 20x130 / BR 20x200	130 / 200	5,5	3,5	10,0

¹⁾ For design according TR 054: $N_{Rk} = N_{Rk,p} = N_{Rk,b}$; $N_{Rk,s}$ according to Table C2 Annex C2; Calculation $N_{Rk,pb}$ see TR 054

²⁾ For $V_{Rk,s}$ see Annex C 2, Table C2; Calculation of $V_{Rk,pb}$ and $V_{Rk,c}$ see TR 054

SCELLEMENT VINYLESTERE FIXH for masonry

Performance Calcium hollow brick KS L-12DF

Characteristic values of resistance under tension and shear load

Annex C 16

Brick type: Clay solid brick Mz-DF

Table C27: Description

Brick type	Clay solid brick Mz-DF	
Bulk density [kg/dm³]	1,64	
Compressive strength [N/mm²]	10, 20 or 28	
Code	EN 771-1	
Producer (country code)	e.g. Unipor (DE)	
Brick dimensions [mm]	240 x 115 x 55	
Drilling method	Hammer drilling	

Table C28: Installation parameter (Edge and spacing distances)

Anchor size	Sleeve	Embedment depth	Edge distance	Spacing	Maximum installation torque
		h_{ef}	$c_{min} = c_{cr}$	$s_{cr} = s_{min \parallel} = s_{min \perp}$	$\max T_{inst}$
		[mm]			[Nm]
M8	-	80	120	240	6
	BR 12x80	80	120	240	
	BR 16x85	85	127	255	
M10	-	90	135	270	10
M12 / M16	-	100	150	300	
M10	BR 16x85	85	127	255	8
	BR 16x130	130	195	390	
	BR 16x130/330	130	195	390	
M12 / M16	BR 20x85	85	127	255	
	BR 20x130	130	195	390	
	BR 20x200	200	300	600	

Table C29: Displacement

h_{ef}	N	δ_{N0}	$\delta_{N\infty}$	V	δ_{V0}	$\delta_{V\infty}$
[mm]	[kN]	[mm]	[mm]	[kN]	[mm]	[mm]
80	$\frac{N_{Rk}}{1,4 \cdot \gamma_M}$	0,12	0,24	$\frac{V_{Rk}}{1,4 \cdot \gamma_M}$	2,27	3,41
85		0,13	0,26		1,22	1,83
90		0,06	0,13		0,71	1,06
100		0,18	0,35		0,43	0,64
130 ; 200		0,42	0,85		1,22	1,83

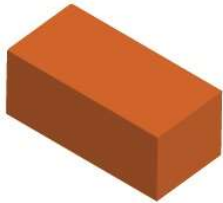
SCELLEMENT VINYLESTERE FIXH for masonry

Performance Clay solid brick Mz-DF

Brick description
Installation parameters, Displacements

Annex C 17

Brick type: Clay solid brick Mz-DF

Table C30: Characteristic values of resistance under tension and shear loads

Anchor size	Sleeve	Effective anchorage depth	Characteristic resistance		
			Use category		
			d/d	w/d	w/w
			40°C / 24°C	80°C / 50°C	For all temperature range
		h_{ef}	$N_{Rk}^{1)}$	$N_{Rk}^{1)}$	$V_{Rk,b}^{2)}$
		[mm]	[kN]		
Compressive strength $f_b \geq 10 \text{ N/mm}^2$					
M8	-	80	1,5	1,2	3,0
M10	-	90	1,5	1,2	3,5
M12	-	100	1,5	0,9	5,0
M16	-	100	2,5	1,5	5,0
M8	BR 12x80	80	2,0	1,5	3,0
	BR 16x85	85	2,0	1,5	3,0
	BR 16x130 / BR 16x130/330	130	3,0	2,0	3,0
M10	BR 16x85	85	2,0	1,5	3,5
	BR 16x130 / BR 16x130/330	130	3,0	2,0	3,5
M12 / M16	BR 20x85	85	2,0	1,5	3,5
	BR 20x130 / BR 20x200	130 / 200	3,0	2,0	3,5
Compressive strength $f_b \geq 20 \text{ N/mm}^2$					
M8	-	80	2,5	1,5	4,5
M10	-	90	2,5	1,5	5,5
M12	-	100	2,0	1,5	7,5
M16	-	100	3,5	2,5	7,5
M8	BR 12x80	80	3,0	2,0	4,0
	BR 16x85	85	3,0	2,0	4,5
	BR 16x130 / BR 16x130/330	130	4,0	2,5	4,5
M10	BR 16x85	85	3,0	2,0	5,0
	BR 16x130 / BR 16x130/330	130	4,5	3,0	5,0
M12 / M16	BR 20x85	85	3,0	2,0	5,0
	BR 20x130 / BR 20x200	130 / 200	4,5	3,0	5,0
Compressive strength $f_b \geq 28 \text{ N/mm}^2$					
M8	-	80	3,0	2,0	5,5
M10	-	90	3,0	2,0	6,5
M12	-	100	2,5	1,5	9,0
M16	-	100	4,5	3,0	9,0
M8	BR 12x80	80	3,5	2,5	5,0
	BR 16x85	85	3,5	2,5	5,0
	BR 16x130 / BR 16x130/330	130	5,0	3,5	5,0
M10	BR 16x85	85	3,5	2,5	6,0
	BR 16x130 / BR 16x130/330	130	5,0	3,5	6,0
M12 / M16	BR 20x85	85	3,5	2,5	6,0
	BR 20x130 / BR 20x200	130 / 200	5,0	3,5	6,0

¹⁾ For design according TR 054: $N_{Rk} = N_{Rk,p} = N_{Rk,b}$; $N_{Rk,s}$ according to Table C2 Annex C2; Calculation $N_{Rk,pb}$ see TR 054

²⁾ For $V_{Rk,s}$ see Annex C 2, Table C2; Calculation of $V_{Rk,pb}$ and $V_{Rk,c}$ see TR 054

SCELLEMENT VINYLESTERE FIXH for masonry

Performance Clay solid brick Mz-DF

Characteristic values of resistance under tension and shear load

Annex C 18

Brick type: Clay hollow brick HLz-16DF

Table C31: Description

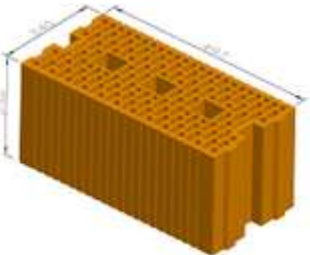
Brick type	Clay hollow brick HLz-16DF	
Bulk density [kg/dm ³]	0,83	
Compressive strength [N/mm ²]	6, 9, 12 or 14	
Code	EN 771-1	
Producer (country code)	e.g. Unipor (DE)	
Brick dimensions [mm]	497 x 238 x 240	
Drilling method	Rotary drilling	

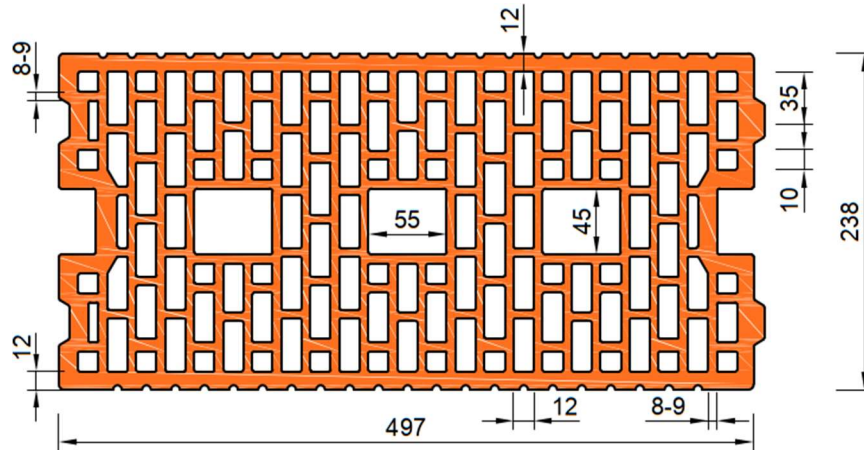

Table C32: Installation parameter (Edge and spacing distances)

Anchor size	Sleeve	Embedment depth	Edge distance	Spacing		Maximum installation torque
		h_{ef}	$C_{min} = C_{cr}$	$S_{cr} = S_{min \parallel}$	$S_{min \perp}$	$\max T_{inst}$
				[mm]		[Nm]
M8	BR 12x80	80	100	497	238	6
M8 / M10	BR 16x85	85				
	BR 16x130	130				
	BR 16x130/330	130				
M12 / M16	BR 20x85	85	120	497	238	6
	BR 20x130	130				
	BR 20x200	200				

Table C33: Displacement

h_{ef}	N	δ_{N0}	$\delta_{N\infty}$	V	δ_{V0}	$\delta_{V\infty}$
[mm]	[kN]	[mm]	[mm]	[kN]	[mm]	[mm]
80	$\frac{N_{Rk}}{1,4 \cdot \gamma_M}$	0,27	0,55	$\frac{V_{Rk}}{1,4 \cdot \gamma_M}$	1,02	1,53
85		0,55	1,10		2,14	3,22
130 ; 200		0,19	0,38		2,26	3,39

SCELLEMENT VINYLESTERE FIXH for masonry

Performance Clay hollow brick HLz-16DF

Brick description
Installation parameters, Displacements

Annex C 19

Brick type: Clay hollow brick HLz-16DF

Table C34: Characteristic values of resistance under tension and shear loads

Anchor size	Sleeve	Effective anchorage depth	Characteristic resistance		
			Use category		
			d/d	w/d	w/w
			40°C / 24°C	80°C / 50°C	For all temperature range
h_{ef}	$N_{Rk}^{1)}$	$N_{Rk}^{1)}$	$V_{Rk,b}^{2)}$		
[mm]	[kN]				
Compressive strength $f_b \geq 6 \text{ N/mm}^2$					
M8	BR 12x80	80	1,2	0,75	2,5
	BR 16x85	85	1,5	1,2	4,0
	BR 16x130	130	2,5	1,5	4,0
	BR 16x130/330	130	2,5	1,5	4,0
M10	BR 16x85	85	1,5	1,2	4,0
	BR 16x130	130	2,5	1,5	6,0
	BR 16x130/330	130	2,5	1,5	6,0
M12 / M16	BR 20x85	85	2,0	1,5	4,0
	BR 20x130 / BR 20x200	130/ 200	2,5	1,5	6,0
Compressive strength $f_b \geq 9 \text{ N/mm}^2$					
M8	BR 12x80	80	1,2	0,9	3,0
	BR 16x85	85	2,0	1,5	4,5
	BR 16x130	130	3,0	2,0	5,0
	BR 16x130/330	130	3,0	2,0	5,0
M10	BR 16x85	85	2,0	1,5	5,0
	BR 16x130	130	3,0	2,0	7,0
	BR 16x130/330	130	3,0	2,0	7,0
M12 / M16	BR 20x85	85	2,5	2,0	5,0
	BR 20x130 / BR 20x200	130/ 200	3,0	2,0	7,0
Compressive strength $f_b \geq 12 \text{ N/mm}^2$					
M8	BR 12x80	80	1,5	1,2	3,5
	BR 16x85	85	2,5	1,5	5,5
	BR 16x130	130	3,5	2,5	6,0
	BR 16x130/330	130	3,5	2,5	6,0
M10	BR 16x85	85	2,5	1,5	6,0
	BR 16x130	130	3,5	2,5	8,0
	BR 16x130/330	130	3,5	2,5	8,0
M12 / M16	BR 20x85	85	3,5	2,0	6,0
	BR 20x130 / BR 20x200	130/ 200	3,5	2,5	8,0
Compressive strength $f_b \geq 14 \text{ N/mm}^2$					
M8	BR 12x80	80	1,5	1,2	4,0
	BR 16x85	85	2,5	2,0	6,0
	BR 16x130	130	3,5	2,5	6,5
	BR 16x130/330	130	3,5	2,5	6,5
M10	BR 16x85	85	2,5	2,0	6,0
	BR 16x130	130	3,5	2,5	9,0
	BR 16x130/330	130	3,5	2,5	9,0
M12 / M16	BR 20x85	85	3,5	2,0	6,0
	BR 20x130 / BR 20x200	130/ 200	3,5	2,5	9,0

¹⁾ For design according TR 054: $N_{Rk} = N_{Rk,p} = N_{Rk,b}$; $N_{Rk,s}$ according to Table C2 Annex C2; Calculation $N_{Rk,pb}$ see TR 054

²⁾ For $V_{Rk,s}$ see Annex C 2, Table C2; Calculation of $V_{Rk,pb}$ and $V_{Rk,c}$ see TR 054

SCELLEMENT VINYLESTERE FIXH for masonry

Performance Clay hollow brick HLz-16DF

Characteristic values of resistance under tension and shear load

Annex C 20

Brick type: Clay hollow brick Porotherm Homebric

Table C35: Description

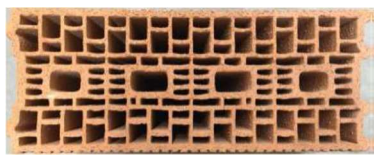
Brick type	Clay hollow brick Porotherm Homebric	
Bulk density [kg/dm³]	0,68	
Compressive strength [N/mm²]	6, 8 or 10	
Code	EN 771-1	
Producer (country code)	e.g. Wienerberger (FR)	
Brick dimensions [mm]	500 x 200 x 299	
Drilling method	Rotary drilling	

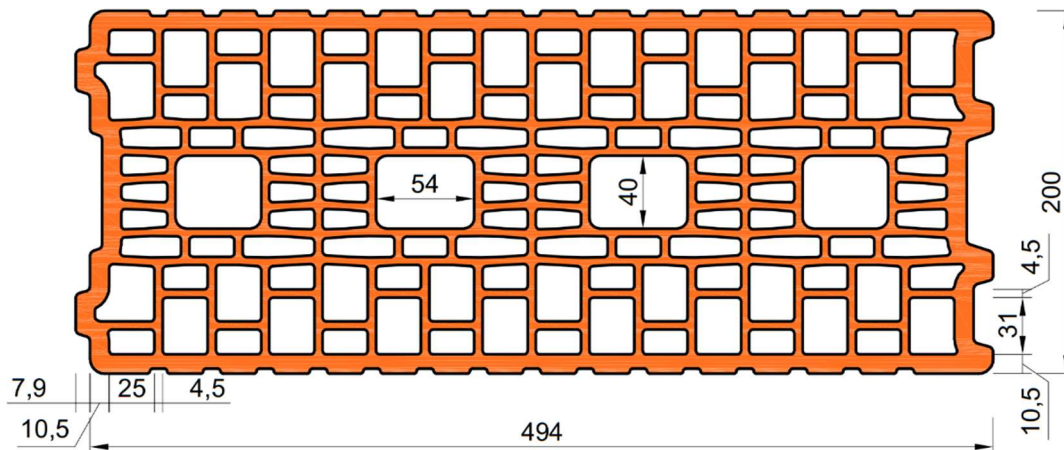

Table C36: Installation parameter (Edge and spacing distances)

Anchor size	Sleeve	Embedment depth	Edge distance	Spacing		Maximum installation torque
				$C_{min} = C_{cr}$	$S_{cr} = S_{min \parallel}$	
		h_{ef}	[mm]			[Nm]
M8	BR 12x80	80	100	500	299	2
M8 / M10	BR 16x85	85				6
	BR 16x130	130				
M12 / M16	BR 16x130/330	130	120	500	299	6
	BR 20x85	85				
	BR 20x130	130				

Table C37: Displacement

h_{ef}	N	δ_{N0}	$\delta_{N\infty}$	V	δ_{V0}	$\delta_{V\infty}$
[mm]	[kN]	[mm]	[mm]	[kN]	[mm]	[mm]
80	$\frac{N_{Rk}}{1,4 \cdot \gamma_M}$	0,65	1,29	$\frac{V_{Rk}}{1,4 \cdot \gamma_M}$	1,26	1,89
85		0,52	1,04		1,89	2,84
130		0,45	0,90		1,48	2,23

SCELLEMENT VINYLESTERE FIXH for masonry

Performance Clay hollow brick Porotherm Homebric

Brick description
Installation parameters, Displacements

Annex C 21

Brick type: Clay hollow brick Porotherm Homebric

Table C38: Characteristic values of resistance under tension and shear loads

Anchor size	Sleeve	Effective anchorage depth	Characteristic resistance		
			Use category d/d w/d w/w		
			40°C / 24°C	80°C / 50°C	For all temperature range
			$N_{Rk}^{1)}$	$N_{Rk}^{1)}$	$V_{Rk,b}^{2)}$
h_{ef}	[kN]				
[mm]					
Compressive strength $f_b \geq 6 \text{ N/mm}^2$					
M8	BR 12x80	80	0,9	0,75	2,0
	BR 16x85	85	1,2	0,75	2,0
	BR 16x130	130	1,5	0,9	2,5
	BR 16x130/330	130	1,5	0,9	2,5
M10	BR 16x85	85	1,2	0,75	2,0
	BR 16x130	130	1,5	0,9	2,5
	BR 16x130/330	130	1,5	0,9	2,5
M12	BR 20x85	85	1,2	0,75	3,0
	BR 20x130	130	1,5	0,9	3,0
M16	BR 20x85	85	1,2	0,75	3,0
	BR 20x130	130	1,5	0,9	3,0
Compressive strength $f_b \geq 8 \text{ N/mm}^2$					
M8	BR 12x80	80	1,2	0,9	2,5
	BR 16x85	85	1,2	0,9	2,5
	BR 16x130	130	1,5	1,2	3,0
	BR 16x130/330	130	1,5	1,2	3,0
M10	BR 16x85	85	1,2	0,9	2,5
	BR 16x130	130	1,5	1,2	3,0
	BR 16x130/330	130	1,5	1,2	3,0
M12	BR 20x85	85	1,2	0,9	3,5
	BR 20x130	130	1,5	1,2	3,5
M16	BR 20x85	85	1,2	0,9	3,5
	BR 20x130	130	1,5	1,2	3,5
Compressive strength $f_b \geq 10 \text{ N/mm}^2$					
M8	BR 12x80	80	1,2	0,9	3,0
	BR 16x85	85	1,5	0,9	3,0
	BR 16x130	130	2,0	1,2	3,5
	BR 16x130/330	130	2,0	1,2	3,5
M10	BR 16x85	85	1,5	0,9	3,0
	BR 16x130	130	2,0	1,2	3,5
	BR 16x130/330	130	2,0	1,2	3,5
M12	BR 20x85	85	1,5	0,9	4,0
	BR 20x130	130	2,0	1,2	4,0
M16	BR 20x85	85	1,5	0,9	4,0
	BR 20x130	130	2,0	1,2	4,0

1) For design according TR 054: $N_{Rk} = N_{Rk,p} = N_{Rk,b}$; $N_{Rk,s}$ according to Table C2 Annex C2; Calculation $N_{Rk,pb}$ see TR 054

2) For $V_{Rk,s}$ see Annex C 2, Table C2; Calculation of $V_{Rk,pb}$ and $V_{Rk,c}$ see TR 054

SCELLEMENT VINYLESTERE FIXH for masonry

Performance Clay hollow brick Porotherm Homebric
Characteristic values of resistance under tension and shear load

Annex C 22

Brick type: Clay hollow brick BGV Thermo

Table C39: Description

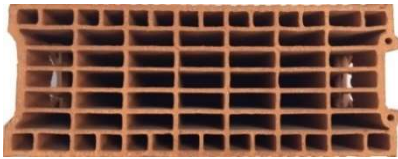
Brick type	Clay hollow brick BGV Thermo	
Bulk density [kg/dm ³]	0,62	
Compressive strength [N/mm ²]	4, 6 or 10	
Code	EN 771-1	
Producer (country code)	e.g. Leroux (FR)	
Brick dimensions [mm]	500 x 200 x 314	
Drilling method	Rotary drilling	

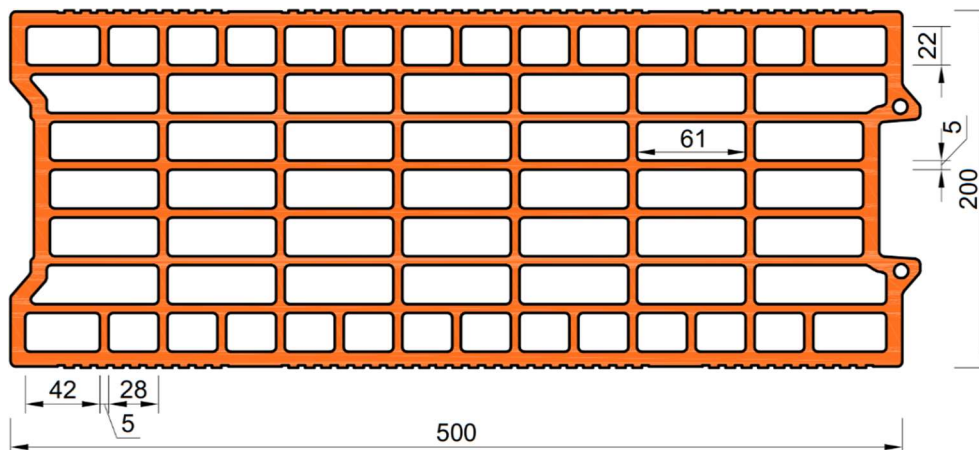

Table C40: Installation parameter (Edge and spacing distances)

Anchor size	Sleeve	Embedment depth	Edge distance	Spacing		Maximum installation torque
				$S_{cr} = S_{min \parallel}$	$S_{min \perp}$	
		h_{ef}	$C_{min} = C_{cr}$	[mm]		$\max T_{inst}$
						[Nm]
M8	BR 12x80	80	100	500	314	2
M8 / M10	BR 16x85	85				4
	BR 16x130	130				
M12 / M16	BR 16x130/330	130	120	500	314	4
	BR 20x85	85				
	BR 20x130	130				

Table C41: Displacement

h_{ef}	N	δ_{N0}	$\delta_{N\infty}$	V	δ_{V0}	$\delta_{V\infty}$
[mm]	[kN]	[mm]	[mm]	[kN]	[mm]	[mm]
80	$\frac{N_{Rk}}{1,4 \cdot \gamma_M}$	0,27	0,54	$\frac{V_{Rk}}{1,4 \cdot \gamma_M}$	1,21	1,81
85		0,39	0,77		2,00	3,01
130		0,16	0,32		1,60	2,39

SCELLEMENT VINYLESTERE FIXH for masonry

Performance Clay hollow brick BGV Thermo

Brick description
Installation parameters, Displacements

Annex C 23

Brick type: Clay hollow brick BGV Thermo

Table C42: Characteristic values of resistance under tension and shear loads

Anchor size	Sleeve	Effective anchorage depth	Characteristic resistance		
			Use category d/d w/d w/w		
			40°C / 24°C	80°C / 50°C	For all temperature range
			$N_{RK}^{1)}$	$N_{RK}^{1)}$	$V_{RK,b}^{2)}$
		[mm]	[kN]		
Compressive strength $f_b \geq 4 \text{ N/mm}^2$					
M8	BR 12x80	80	0,5	0,4	2,0
	BR 16x85	85	0,75	0,5	2,0
	BR 16x130	130	0,9	0,75	2,5
	BR 16x130/330	130	0,9	0,75	2,5
M10	BR 16x85	85	0,75	0,5	2,0
	BR 16x130	130	1,2	0,75	2,5
	BR 16x130/330	130	1,2	0,75	2,5
M12	BR 20x85	85	0,75	0,5	2,0
	BR 20x130	130	1,2	0,75	2,5
M16	BR 20x85	85	0,9	0,6	2,0
	BR 20x130	130	1,2	0,75	2,5
Compressive strength $f_b \geq 6 \text{ N/mm}^2$					
M8	BR 12x80	80	0,6	0,5	2,0
	BR 16x85	85	0,9	0,6	2,5
	BR 16x130	130	1,2	0,9	3,0
	BR 16x130/330	130	1,2	0,9	3,0
M10	BR 16x85	85	0,9	0,6	2,5
	BR 16x130	130	1,5	0,9	3,0
	BR 16x130/330	130	1,5	0,9	3,0
M12	BR 20x85	85	0,9	0,6	3,0
	BR 20x130	130	1,5	0,9	3,0
M16	BR 20x85	85	1,2	0,75	3,0
	BR 20x130	130	1,5	0,9	3,0
Compressive strength $f_b \geq 10 \text{ N/mm}^2$					
M8	BR 12x80	80	0,9	0,6	3,0
	BR 16x85	85	1,2	0,9	3,5
	BR 16x130	130	1,5	1,2	4,0
	BR 16x130/330	130	1,5	1,2	4,0
M10	BR 16x85	85	1,2	0,9	3,5
	BR 16x130	130	1,5	1,2	4,0
	BR 16x130/330	130	1,5	1,2	4,0
M12	BR 20x85	85	1,2	0,75	3,5
	BR 20x130	130	1,5	1,2	4,0
M16	BR 20x85	85	1,5	0,9	3,5
	BR 20x130	130	1,5	1,2	4,0

¹⁾ For design according TR 054: $N_{RK} = N_{RK,p} = N_{RK,b}$; $N_{RK,s}$ according to Table C2 Annex C2; Calculation $N_{RK,pb}$ see TR 054

²⁾ For $V_{RK,s}$ see Annex C 2, Table C2; Calculation of $V_{RK,pb}$ and $V_{RK,c}$ see TR 054

SCELLEMENT VINYLESTERE FIXH for masonry

Performance Clay hollow brick BGV Thermo
Characteristic values of resistance under tension and shear load

Annex C 24

Brick type: Clay hollow brick Calibric Th

Table C43: Description

Brick type	Clay hollow brick Calibric Th	
Bulk density [kg/dm ³]	0,62	
Compressive strength [N/mm ²]	6, 9 or 12	
Code	EN 771-1	
Producer (country code)	e.g. Terreal (FR)	
Brick dimensions [mm]	500 x 200 x 314	
Drilling method	Rotary drilling	

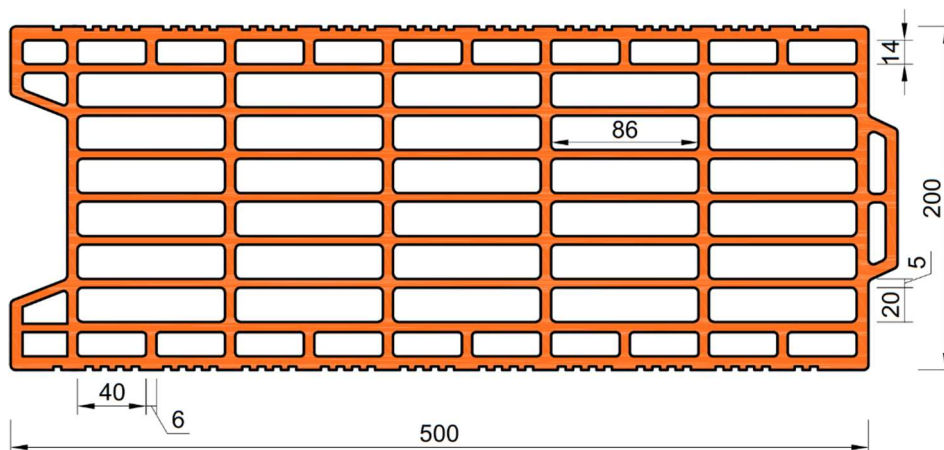

Table C44: Installation parameter (Edge and spacing distances)

Anchor size	Sleeve	Embedment depth	Edge distance	Spacing		Maximum installation torque
				$S_{cr} = S_{min \parallel}$	$S_{min \perp}$	
		h_{ef}	$C_{min} = C_{cr}$	[mm]		$\max T_{inst}$
						[Nm]
M8	BR 12x80	80	100	500	314	2
M8 / M10	BR 16x85	85				
	BR 16x130 BR 16x130/330	130				
M12 / M16	BR 20x85	85	120	500	314	2
	BR 20x130	130				

Table C45: Displacement

h_{ef}	N	δ_{N0}	$\delta_{N\infty}$	V	δ_{V0}	$\delta_{V\infty}$
[mm]	[kN]	[mm]	[mm]	[kN]	[mm]	[mm]
80	$\frac{N_{Rk}}{1,4 \cdot \gamma_M}$	0,48	0,96	$\frac{V_{Rk}}{1,4 \cdot \gamma_M}$	1,18	1,78
85		0,49	0,98		2,20	3,30
130		0,37	0,74		2,31	3,46

SCELLEMENT VINYLESTERE FIXH for masonry

Performance Clay hollow brick Calibric Th

Brick description
Installation parameters, Displacements

Annex C 25

Brick type: Clay hollow brick Calibric Th

Table C46: Characteristic values of resistance under tension and shear loads

Anchor size	Sleeve	Effective anchorage depth	Characteristic resistance		
			Use category		
			d/d w/d w/w		
			40°C / 24°C	80°C / 50°C	For all temperature range
h_{ef}	$N_{Rk}^{1)}$	$N_{Rk}^{1)}$	$V_{Rk,b}^{2)}$		
[mm]	[kN]				
Compressive strength $f_b \geq 6 \text{ N/mm}^2$					
M8	BR 12x80	80	0,75	0,5	2,5
	BR 16x85	85	0,75	0,5	3,5
	BR 16x130	130	0,9	0,6	3,5
	BR 16x130/330	130	0,9	0,6	3,5
M10	BR 16x85	85	0,75	0,5	3,5
	BR 16x130	130	0,9	0,6	3,5
	BR 16x130/330	130	0,9	0,6	3,5
M12	BR 20x85	85	0,75	0,5	6,0
	BR 20x130	130	0,9	0,6	6,0
M16	BR 20x85	85	1,2	0,75	6,0
	BR 20x130	130	1,2	0,75	6,0
Compressive strength $f_b \geq 9 \text{ N/mm}^2$					
M8	BR 12x80	80	0,9	0,6	3,5
	BR 16x85	85	0,9	0,6	4,5
	BR 16x130	130	1,2	0,75	4,5
	BR 16x130/330	130	1,2	0,75	4,5
M10	BR 16x85	85	0,9	0,6	4,5
	BR 16x130	130	1,2	0,9	4,5
	BR 16x130/330	130	1,2	0,9	4,5
M12	BR 20x85	85	0,9	0,6	7,5
	BR 20x130	130	1,2	0,9	7,5
M16	BR 20x85	85	1,5	0,9	7,5
	BR 20x130	130	1,5	0,9	7,5
Compressive strength $f_b \geq 12 \text{ N/mm}^2$					
M8	BR 12x80	80	0,9	0,75	4,0
	BR 16x85	85	0,9	0,75	5,5
	BR 16x130	130	1,2	0,9	5,5
	BR 16x130/330	130	1,2	0,9	5,5
M10	BR 16x85	85	0,9	0,75	5,5
	BR 16x130	130	1,5	0,9	5,5
	BR 16x130/330	130	1,5	0,9	5,5
M12	BR 20x85	85	0,9	0,75	8,5
	BR 20x130	130	1,5	0,9	8,5
M16	BR 20x85	85	1,5	1,2	8,5
	BR 20x130	130	1,5	1,2	8,5

1) For design according TR 054: $N_{Rk} = N_{Rk,p} = N_{Rk,b}$; $N_{Rk,s}$ according to Table C2 Annex C2; Calculation $N_{Rk,pb}$ see TR 054

2) For $V_{Rk,s}$ see Annex C 2, Table C2; Calculation of $V_{Rk,pb}$ and $V_{Rk,c}$ see TR 054

SCELLEMENT VINYLESTERE FIXH for masonry

Performance Clay hollow brick Calibric Th
Characteristic values of resistance under tension and shear load

Annex C 26

Brick type: Clay hollow brick Urbanbric

Table C47: Description

Brick type	Clay hollow brick Urbanbric	
Bulk density [kg/dm ³]	0,74	
Compressive strength [N/mm ²]	6 or 9	
Code	EN 771-1	
Producer (country code)	e.g. Imerys (FR)	
Brick dimensions [mm]	560 x 200 x 274	
Drilling method	Rotary drilling	

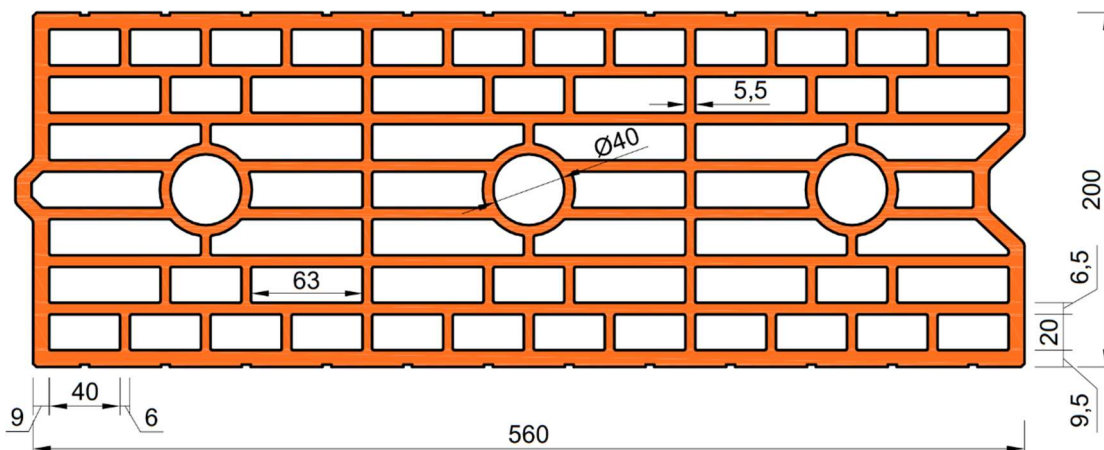

Table C48: Installation parameter (Edge and spacing distances)

Anchor size	Sleeve	Embedment depth	Edge distance	Spacing		Maximum installation torque
		h_{ef}	$C_{min} = C_{cr}$	$S_{cr} = S_{min \parallel}$	$S_{min \perp}$	$\max T_{inst}$
				[mm]		[Nm]
M8	BR 12x80	80	100	560	274	2
M8 / M10	BR 16x85	85				
	BR 16x130	130				
	BR 16x130/330	130				
M12 / M16	BR 20x85	85	120	560	274	2
	BR 20x130	130				

Table C49: Displacement

h_{ef}	N	δ_{N0}	$\delta_{N\infty}$	V	δ_{V0}	$\delta_{V\infty}$
[mm]	[kN]	[mm]	[mm]	[kN]	[mm]	[mm]
80	$\frac{N_{Rk}}{1,4 \cdot \gamma_M}$	0,34	0,67	$\frac{V_{Rk}}{1,4 \cdot \gamma_M}$	0,71	1,06
85		0,52	1,04		1,37	2,06
130		0,62	1,24		1,62	2,44

SCELLEMENT VINYLESTERE FIXH for masonry

Performance Clay hollow brick Urbanbric

Brick description
Installation parameters, Displacements

Annex C 27

Brick type: Clay hollow brick Urbanbric

Table C50: Characteristic values of resistance under tension and shear loads

Anchor size	Sleeve	Effective anchorage depth	Characteristic resistance		
			Use category d/d w/d w/w		
			40°C / 24°C	80°C / 50°C	For all temperature range
			$N_{RK}^{1)}$	$N_{RK}^{1)}$	$V_{RK,b}^{2)}$
		h_{ef}	[kN]		
		[mm]			
Compressive strength $f_b \geq 6 \text{ N/mm}^2$					
M8	BR 12x80	80	0,9	0,75	3,0
M8 / M10	BR 16x85	85	1,2	0,75	3,5
	BR 16x130	130	1,5	1,2	3,5
	BR 16x130/330	130	1,5	1,2	3,5
M12 / M16	BR 20x85	85	1,2	0,75	4,0
	BR 20x130	130	1,5	1,2	4,0
Compressive strength $f_b \geq 9 \text{ N/mm}^2$					
M8	BR 12x80	80	1,2	0,9	3,5
M8 / M10	BR 16x85	85	1,5	0,9	4,0
	BR 16x130	130	2,0	1,5	4,5
	BR 16x130/330	130	2,0	1,5	4,5
M12 / M16	BR 20x85	85	1,5	0,9	5,0
	BR 20x130	130	2,0	1,5	5,0

1) For design according TR 054: $N_{RK} = N_{RK,p} = N_{RK,b}$; $N_{RK,s}$ according to Table C2 Annex C2; Calculation $N_{RK,pb}$ see TR 054

2) For $V_{RK,s}$ see Annex C 2, Table C2; Calculation of $V_{RK,pb}$ and $V_{RK,c}$ see TR 054

SCELLEMENT VINYLESTERE FIXH for masonry

Performance Clay hollow brick Urbanbric
Characteristic values of resistance under tension and shear load

Annex C 28

Brick type: Clay hollow brick Blocchi Leggeri

Table C51: Description

Brick type	Clay hollow brick Blocchi Leggeri	
Bulk density [kg/dm³]	0,55	
Compressive strength [N/mm²]	4, 6 or 8	
Code	EN 771-1	
Producer (country code)	e.g. Wienerberger (IT)	
Brick dimensions [mm]	250 x 120 x 250	
Drilling method	Rotary drilling	

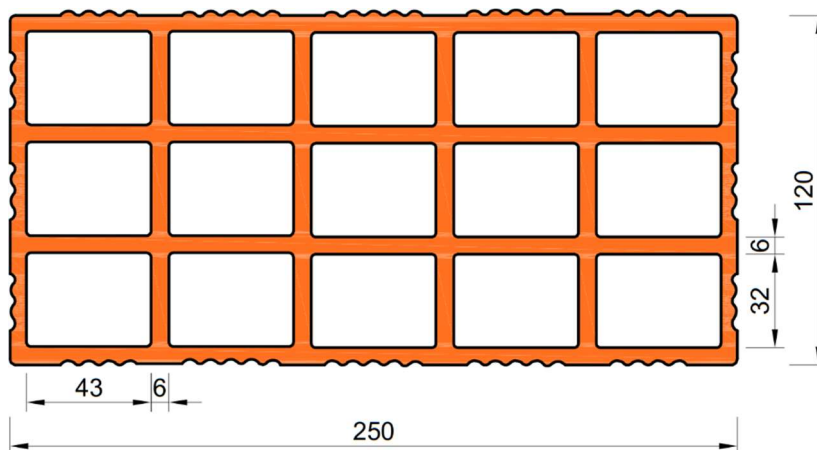

Table C52: Installation parameter (Edge and spacing distances)

Anchor size	Sleeve	Embedment depth	Edge distance	Spacing		Maximum installation torque
				$S_{cr} = S_{min \parallel}$	$S_{min \perp}$	
		h_{ef}	$C_{min} = C_{cr}$	[mm]		$\max T_{inst}$
						[Nm]
M8	BR 12x80	80	100	250	250	4
M8 / M10	BR 16x85	85				
	BR 16x130	130				
	BR 16x130/330	130				
M12 / M16	BR 20x85	85	120	250	250	4
	BR 20x130	130				
	BR 20x200	200				

Table C53: Displacement

h_{ef}	N	δ_{N0}	$\delta_{N\infty}$	V	δ_{V0}	$\delta_{V\infty}$
[mm]	[kN]	[mm]	[mm]	[kN]	[mm]	[mm]
80	$\frac{N_{Rk}}{1,4 \cdot \gamma_M}$	0,32	0,64	$\frac{V_{Rk}}{1,4 \cdot \gamma_M}$	1,16	1,74
85		0,26	0,53		2,52	3,78
130 ; 200		0,32	0,64		2,52	3,78

SCELLEMENT VINYLESTERE FIXH for masonry

Performance Clay hollow brick Blocchi Leggeri

Brick description
Installation parameters, Displacements

Annex C 29

Brick type: Clay hollow brick Blocchi Leggeri

Table C54: Characteristic values of resistance under tension and shear loads

Anchor size	Sleeve	Effective anchorage depth	Characteristic resistance		
			Use category d/d w/d w/w		
			40°C / 24°C	80°C / 50°C	For all temperature range
			$N_{Rk}^{1)}$	$N_{Rk}^{1)}$	$V_{Rk,b}^{2)}$
		[mm]	[kN]		
Compressive strength $f_b \geq 4 \text{ N/mm}^2$					
M8	BR 12x80	80	0,4	0,3	2,0
M8 / M10	BR 16x85	85	0,4	0,3	2,0
	BR 16x130	130	0,5	0,3	2,0
	BR 16x130/330	130	0,5	0,3	2,0
M12 / M16	BR 20x85	85	0,4	0,3	2,0
	BR 20x130	130	0,5	0,3	2,0
	BR 20x200	200	0,5	0,3	2,0
Compressive strength $f_b \geq 6 \text{ N/mm}^2$					
M8	BR 12x80	80	0,5	0,3	2,0
M8 / M10	BR 16x85	85	0,5	0,3	2,0
	BR 16x130	130	0,6	0,4	2,0
	BR 16x130/330	130	0,6	0,4	2,0
M12 / M16	BR 20x85	85	0,5	0,3	2,5
	BR 20x130	130	0,6	0,4	2,5
	BR 20x200	200	0,6	0,4	2,5
Compressive strength $f_b \geq 8 \text{ N/mm}^2$					
M8	BR 12x80	80	0,6	0,4	2,5
M8 / M10	BR 16x85	85	0,6	0,4	2,5
	BR 16x130	130	0,6	0,5	2,5
	BR 16x130/330	130	0,6	0,5	2,5
M12 / M16	BR 20x85	85	0,6	0,4	3,0
	BR 20x130	130	0,6	0,5	3,0
	BR 20x200	200	0,6	0,5	3,0

1) For design according TR 054: $N_{Rk} = N_{Rk,p} = N_{Rk,b}$; $N_{Rk,s}$ according to Table C2 Annex C2; Calculation $N_{Rk,pt}$ see TR 054

2) For $V_{Rk,s}$ see Annex C 2, Table C2; Calculation of $V_{Rk,pt}$ and $V_{Rk,c}$ see TR 054

SCELLEMENT VINYLESTERE FIXH for masonry

Performance Clay hollow brick Blocchi Leggeri
Characteristic values of resistance under tension and shear load

Annex C 30

Brick type: Clay hollow brick Doppio Uni

Table C55: Description

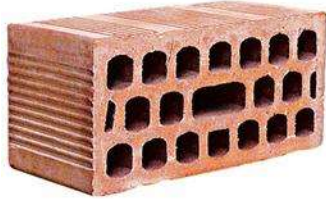
Brick type	Clay hollow brick Doppio Uni	
Bulk density [kg/dm ³]	0,92	
Compressive strength [N/mm ²]	10, 16, 20 or 28	
Code	EN 771-1	
Producer (country code)	e.g. Wienerberger (IT)	
Brick dimensions [mm]	250 x 120 x 120	
Drilling method	Rotary drilling	

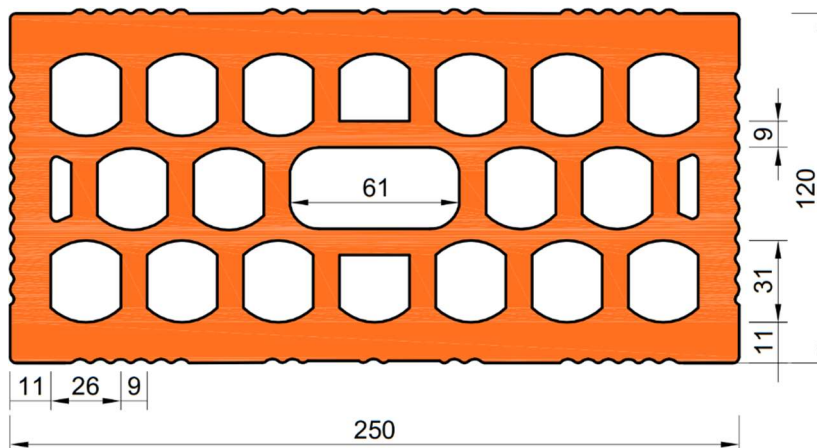

Table C56: Installation parameter (Edge and spacing distances)

Anchor size	Sleeve	Embedment depth	Edge distance	Spacing		Maximum installation torque
		h_{ef}	$C_{min} = C_{cr}$	$S_{cr} = S_{min \parallel}$	$S_{min \perp}$	$\max T_{inst}$
				[mm]		[Nm]
M8	BR 12x80	80	100	250	120	4
M8 / M10	BR 16x85	85				
	BR 16x130	130				
	BR 16x130/330	130				
M12 / M16	BR 20x85	85	120	250	120	4
	BR 20x130	130				
	BR 20x200	200				

Table C57: Displacement

h_{ef}	N	δ_{N0}	$\delta_{N\infty}$	V	δ_{V0}	$\delta_{V\infty}$
[mm]	[kN]	[mm]	[mm]	[kN]	[mm]	[mm]
80	$\frac{N_{Rk}}{1,4 \cdot \gamma_M}$	0,54	1,08	$\frac{V_{Rk}}{1,4 \cdot \gamma_M}$	1,63	2,45
85		0,17	0,34		1,75	2,63
130 ; 200		0,54	1,08		1,75	2,63

SCELLEMENT VINYLESTERE FIXH for masonry

Performance Clay hollow brick Doppio Uni

Brick description
Installation parameters, Displacements

Annex C 31

Brick type: Clay hollow brick Doppio Uni

Table C58: Characteristic values of resistance under tension and shear loads

Anchor size	Sleeve	Effective anchorage depth	Characteristic resistance		
			Use category		
			d/d w/d w/w		
			40°C / 24°C	80°C / 50°C	For all temperature range
h_{ef} [mm]	$N_{Rk}^{1)}$	$N_{Rk}^{1)}$	$V_{Rk,b}^{2)}$		
[kN]					
Compressive strength $f_b \geq 10 \text{ N/mm}^2$					
M8	BR 12x80	80	0,9	0,6	2,0
M8 / M10	BR 16x85	85	0,9	0,6	2,0
	BR 16x130	130	0,9	0,6	2,0
	BR 16x130/330	130	0,9	0,6	2,0
M12 / M16	BR 20x85	85	1,2	0,75	2,0
	BR 20x130	130	1,2	0,75	2,0
	BR 20x200	200	1,2	0,75	2,0
Compressive strength $f_b \geq 16 \text{ N/mm}^2$					
M8	BR 12x80	80	0,9	0,75	2,5
M8 / M10	BR 16x85	85	1,2	0,9	2,5
	BR 16x130	130	1,2	0,9	2,5
	BR 16x130/330	130	1,2	0,9	2,5
M12 / M16	BR 20x85	85	1,5	0,9	2,5
	BR 20x130	130	1,5	0,9	2,5
	BR 20x200	200	1,5	0,9	2,5
Compressive strength $f_b \geq 20 \text{ N/mm}^2$					
M8	BR 12x80	80	1,2	0,75	3,0
M8 / M10	BR 16x85	85	1,2	0,9	3,0
	BR 16x130	130	1,5	0,9	3,0
	BR 16x130/330	130	1,5	0,9	3,0
M12 / M16	BR 20x85	85	1,5	0,9	3,0
	BR 20x130	130	1,5	0,9	3,0
	BR 20x200	200	1,5	0,9	3,0
Compressive strength $f_b \geq 28 \text{ N/mm}^2$					
M8	BR 12x80	80	1,5	0,9	3,5
M8 / M10	BR 16x85	85	1,5	1,2	3,5
	BR 16x130	130	1,5	1,2	3,5
	BR 16x130/330	130	1,5	1,2	3,5
M12 / M16	BR 20x85	85	2,0	1,2	3,5
	BR 20x130	130	2,0	1,2	3,5
	BR 20x200	200	2,0	1,2	3,5

¹⁾ For design according TR 054: $N_{Rk} = N_{Rk,p} = N_{Rk,b}$; $N_{Rk,s}$ according to Table C2 Annex C2; Calculation $N_{Rk,pt}$ see TR 054

²⁾ For $V_{Rk,s}$ see Annex C 2, Table C2; Calculation of $V_{Rk,pt}$ and $V_{Rk,c}$ see TR 054

SCELLEMENT VINYLESTERE FIXH for masonry

Performance Clay hollow brick Doppio Uni
Characteristic values of resistance under tension and shear load

Annex C 32

Brick type: Hollow Light weight concrete Bloc creux B40

Table C59: Description

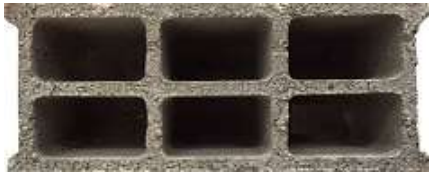
Brick type	Hollow light weight concrete Bloc creux B40	
Bulk density [kg/dm³]	0,8	
Compressive strength [N/mm²]	4	
Code	EN 771-3	
Producer (country code)	e.g. Sepa (FR)	
Brick dimensions [mm]	494 x 200 x 190	
Drilling method	Rotary drilling	

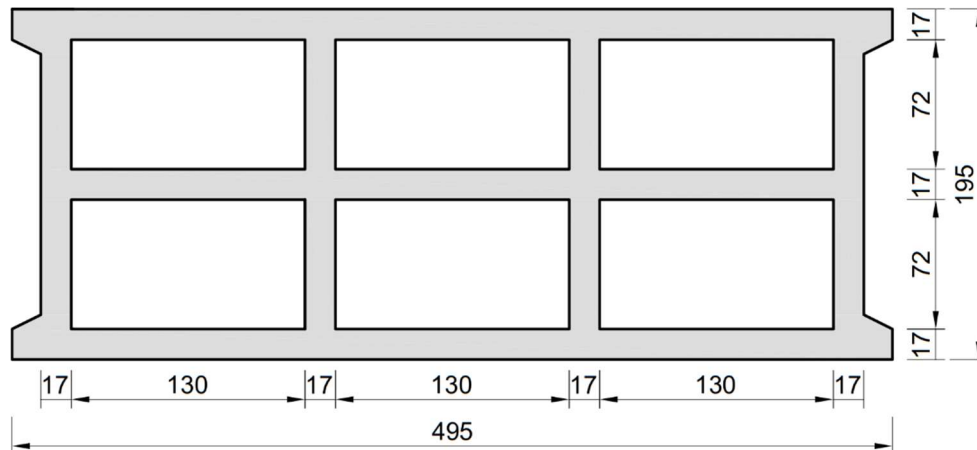

Table C60: Installation parameter (Edge and spacing distances)

Anchor size	Sleeve	Embedment depth	Edge distance	Spacing		Maximum installation torque			
				h_{ef}	$C_{min} = C_{cr}$		$S_{cr} = S_{min II}$	$S_{min \perp}$	$\max T_{inst}$
				[mm]				[Nm]	
M8	BR 12x80	80	100	494	190	2			
M8 / M10	BR 16x85	85							
	BR 16x130	130							
	BR 16x130/330	130							
M12 / M16	BR 20x85	85	120	494	190	2			
	BR 20x130	130							

Table C61: Displacement

h_{ef}	N	δ_{N0}	$\delta_{N\infty}$	V	δ_{V0}	$\delta_{V\infty}$
[mm]	[kN]	[mm]	[mm]	[kN]	[mm]	[mm]
80	$\frac{N_{Rk}}{1,4 \cdot \gamma_M}$	0,14	0,29	$\frac{V_{Rk}}{1,4 \cdot \gamma_M}$	0,25	0,37
85		0,45	0,90		0,98	1,47
130		0,61	1,22		1,10	1,65

SCELLEMENT VINYLESTERE FIXH for masonry

Performance hollow light weight concrete Bloc creux B40

Brick description
Installation parameters, Displacements

Annex C 33

Brick type: Hollow Light weight concrete Bloc creux B40

Table C62: Characteristic values of resistance under tension and shear loads

Anchor size	Sleeve	Effective anchorage depth	Characteristic resistance		
			Use category d/d w/d w/w		
			40°C / 24°C	80°C / 50°C	For all temperature range
			$N_{Rk}^{1)}$	$N_{Rk}^{1)}$	$V_{Rk,b}^{2)}$
	h_{ef} [mm]		[kN]		
Compressive strength $f_b \geq 4 \text{ N/mm}^2$					
M8	BR 12x80	80	0,4	0,3	1,2
	BR 16x85	85	0,6	0,5	3,0
	BR 16x130	130	2,0	1,5	3,5
	BR 16x130/330	130	2,0	1,5	3,5
M10	BR 16x85	85	0,6	0,5	3,0
	BR 16x130	130	2,0	1,5	3,5
	BR 16x130/330	130	2,0	1,5	3,5
M12	BR 20x85	85	0,9	0,6	3,0
	BR 20x130	130	2,0	1,5	3,5
M16	BR 20x85	85	0,9	0,6	3,0
	BR 20x130	130	2,0	1,5	3,5

1) For design according TR 054: $N_{Rk} = N_{Rk,p} = N_{Rk,b}$; $N_{Rk,s}$ according to Table C2 Annex C2; Calculation $N_{Rk,pb}$ see TR 054

2) For $V_{Rk,s}$ see Annex C 2, Table C2; Calculation of $V_{Rk,pb}$ and $V_{Rk,c}$ see TR 054

SCELLEMENT VINYLESTERE FIXH for masonry

Performance hollow light weight concrete Bloc creux B40
Characteristic values of resistance under tension and shear load

Annex C 34

Brick type: Solid light weight concrete brick

Table C63: Description

Brick type	Solid light weight concrete brick	
Bulk density [kg/dm ³]	0,63	
Compressive strength [N/mm ²]	2	
Code	EN 771-3	
Producer (country code)	e.g. Bisotherm (DE)	
Brick dimensions [mm]	300 x 123 x 248	
Drilling method	Rotary drilling	

Table C64: Installation parameter (Edge and spacing distances)

Anchor size	Sleeve	Embedment depth	Edge distance	Spacing	Maximum installation torque
		h_{ef}	$C_{min} = C_{cr}$	$S_{cr} = S_{min \parallel} = S_{min \perp}$	$\max T_{inst}$
		[mm]			[Nm]
M8	-	80	120	240	6
M10	-	90	135	270	
M12	-	100	150	300	10
M16	-	100	150	300	14

Table C65: Displacement

h_{ef}	N	δ_{N0}	$\delta_{N\infty}$	V	δ_{V0}	$\delta_{V\infty}$
[mm]	[kN]	[mm]	[mm]	[kN]	[mm]	[mm]
80	$\frac{N_{Rk}}$	0,64	1,28	$\frac{V_{Rk}}$	0,50	0,75
90		0,70	1,41		0,68	1,03
100	$1,4 \cdot \gamma_M$	0,21	0,42	$1,4 \cdot \gamma_M$	0,54	0,81

SCELLEMENT VINYLESTERE FIXH for masonry

Performance Solid light weight concrete LAC

Brick description

Installation parameters, Displacements

Annex C 35

Brick type: Solid light weight concrete brick

Table C66: Characteristic values of resistance under tension and shear loads

Anchor size	Sleeve	Effective anchorage depth	Characteristic resistance		
			Use category		
			d/d w/d w/w		
			40°C / 24°C	80°C / 50°C	For all temperature range
h_{ef}	$N_{Rk}^{1)}$	$N_{Rk}^{1)}$	$V_{Rk,b}^{2)}$		
[mm]	[kN]				
Compressive strength $f_b \geq 2 \text{ N/mm}^2$					
M8	-	80	2,0	1,5	3,0
M10	-	90	2,0	1,5	3,5
M12	-	100	2,0	1,5	4,0
M16	-	100	2,0	1,5	4,0

1) For design according TR 054: $N_{Rk} = N_{Rk,p} = N_{Rk,b}$; $N_{Rk,s}$ according to Table C2 Annex C2; Calculation $N_{Rk,pb}$ see TR 054

2) For $V_{Rk,s}$ see Annex C 2, Table C2; Calculation of $V_{Rk,pb}$ and $V_{Rk,c}$ see TR 054

SCELLEMENT VINYLESTERE FIXH for masonry

Performance Solid light weight concrete LAC
Characteristic values of resistance under tension and shear load

Annex C 36

Brick type: Hollow light weight concrete brick – Leca Lex harkko RUH-200

Table C67: Description

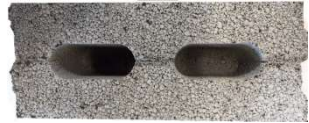
Brick type	Hollow light weight concrete Leca Lex harkko RUH-200	
Bulk density [kg/dm³]	0,7	
Compressive strength [N/mm²]	2,7	
Code	EN 771-3	
Producer (country code)	e.g. Saint-Gobain Weber (Fin)	
Brick dimensions [mm]	498 x 200 x 195	
Drilling method	Rotary drilling	

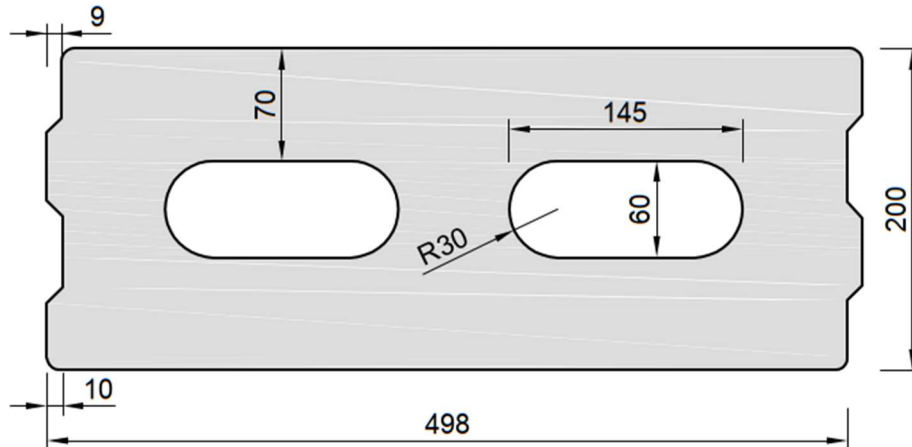

Table C68: Installation parameter (Edge and spacing distances)

Anchor size	Sleeve	Embedment depth	Edge distance	Spacing		Maximum installation torque
				$S_{cr} = S_{min \parallel}$	$S_{min \perp}$	
		h_{ef}	$C_{min} = C_{cr}$	[mm]		$\max T_{inst}$
						[Nm]
M8	BR 12x80	80	120	498	195	8
M8 / M10	BR 16x85	85	127			
	BR 16x130	130	195			
	BR 16x130/330	130	195			
M12 / M16	BR 20x85	85	127			
	BR 20x130	130	195			

Table C69: Displacement

h_{ef}	N	δ_{N0}	$\delta_{N\infty}$	V	δ_{V0}	$\delta_{V\infty}$
[mm]	[kN]	[mm]	[mm]	[kN]	[mm]	[mm]
80	$\frac{N_{Rk}}{1,4 \cdot \gamma_M}$	0,11	0,22	$\frac{V_{Rk}}{1,4 \cdot \gamma_M}$	0,47	0,70
85		0,11	0,23		0,38	0,57
130		0,10	0,20		0,56	0,85

SCELLEMENT VINYLESTERE FIXH for masonry

Performance LECA LEX harkko RUH-200 Hollow
Brick description
Installation parameters, Displacements

Annex C 37

Brick type: Hollow light weight concrete brick – Leca Lex harkko RUH-200

Table C70: Characteristic values of resistance under tension and shear loads

Anchor size	Sleeve	Effective anchorage depth	Characteristic resistance		
			Use category		
			d/d w/d w/w		
			40°C / 24°C	80°C / 50°C	For all temperature range
h_{ef}	$N_{Rk}^{1)}$	$N_{Rk}^{1)}$	$V_{Rk,b}^{2)}$		
[mm]	[kN]				
Compressive strength $f_b \geq 2,7 \text{ N/mm}^2$					
M8	BR 12x80	80	2,0	1,2	2,5
	BR 16x85	85	2,0	1,2	3,5
	BR 16x130	130	2,5	1,5	3,5
	BR 16x130/330	130	2,5	1,5	3,5
M10	BR 16x85	85	2,0	1,5	3,5
	BR 16x130	130	2,5	1,5	3,5
	BR 16x130/330	130	2,5	1,5	3,5
M12	BR 20x85	85	2,5	1,5	3,5
	BR 20x130	130	2,5	1,5	3,5
M16	BR 20x85	85	2,5	1,5	3,5
	BR 20x130	130	2,5	1,5	3,5

1) For design according TR 054: $N_{Rk} = N_{Rk,p} = N_{Rk,b}$; $N_{Rk,s}$ according to Table C2 Annex C2; Calculation $N_{Rk,pb}$ see TR 054

2) For $V_{Rk,s}$ see Annex C 2, Table C2; Calculation of $V_{Rk,pb}$ and $V_{Rk,c}$ see TR 054

SCELLEMENT VINYLESTERE FIXH for masonry

Performance LECA LEX harkko RUH-200 Hollow
 Characteristic values of resistance under tension and shear load
 Displacement

Annex C 38

Brick type: Solid light weight concrete brick – Leca Lex harkko RUH-200 kulma

Table C71: Description

Brick type	Solid light weight concrete Leca Lex harkko RUH-200 kulma	
Bulk density [kg/dm ³]	0,78	
Compressive strength [N/mm ²]	3	
Code	EN 771-3	
Producer (country code)	e.g. Saint-Gobain Weber (Fin)	
Brick dimensions [mm]	498 x 200 x 195	
Drilling method	Rotary drilling	

Table C72: Installation parameter (Edge and spacing distances)

Anchor size	Sleeve	Embedment depth	Edge distance	Spacing	Maximum installation torque
		h_{ef}	$c_{min} = c_{cr}$	$s_{cr} = s_{min \parallel} = s_{min \perp}$	$\max T_{inst}$
			[mm]		[Nm]
M8	-	80	120	240	6
M10	-	90	135	270	12
M12	-	100	150	300	14
M16	-	100	150	300	16
M8	BR 12x80	80	120	240	8
M8 / M10	BR 16x85	85	127	255	
	BR 16x130	130	195	390	
	BR 16x130/330	130	195	390	
M12 / M16	BR 20x85	85	127	255	12
	BR 20x130	130	195	390	16

Table C73: Displacement

h_{ef}	N	δ_{N0}	$\delta_{N\infty}$	V	δ_{V0}	$\delta_{V\infty}$
[mm]	[kN]	[mm]	[mm]	[kN]	[mm]	[mm]
80	$\frac{N_{Rk}}{1,4 \cdot \gamma_M}$	0,09	0,18	$\frac{V_{Rk}}{1,4 \cdot \gamma_M}$	0,48	0,72
85		0,07	0,15		0,77	1,15
90		0,13	0,26		0,26	0,39
100		0,13	0,23		0,36	0,54
130		0,10	0,21		0,68	1,01

SCELLEMENT VINYLESTERE FIXH for masonry

Performance LECA LEX harkko RUH-200 Kulma Solid

Brick description
Installation parameters, Displacements

Annex C 39

Brick type: Solid light weight concrete brick – Leca Lex harkko RUH-200 kulma

Table C74: Characteristic values of resistance under tension and shear loads

Anchor size	Sleeve	Effective anchorage depth	Characteristic resistance		
			Use category		
			d/d w/d w/w		
			40°C / 24°C	80°C / 50°C	For all temperature range
h_{ef}	$N_{Rk}^{1)}$	$N_{Rk}^{1)}$	$V_{Rk,b}^{2)}$		
[mm]	[kN]				
Compressive strength $f_b \geq 3,0 \text{ N/mm}^2$					
M8	-	80	2,0	1,2	3,0
M10	-	90	3,0	2,0	4,0
M12	-	100	3,0	2,0	4,0
M16	-	100	3,0	2,0	4,0
M8	BR 12x80	80	2,0	1,2	3,0
	BR 16x85	85	2,0	1,5	3,5
	BR 16x130	130	3,0	2,0	4,0
	BR 16x130/330	130	3,0	2,0	4,0
M10	BR 16x85	85	2,0	1,5	3,5
	BR 16x130	130	3,0	2,0	4,0
	BR 16x130/330	130	3,0	2,0	4,0
M12 / M16	BR 20x85	85	2,0	1,5	4,5
	BR 20x130	130	3,0	2,0	4,5

1) For design according TR 054: $N_{Rk} = N_{Rk,p} = N_{Rk,b}$; $N_{Rk,s}$ according to Table C2 Annex C2; Calculation $N_{Rk,pb}$ see TR 054

2) For $V_{Rk,s}$ see Annex C 2, Table C2; Calculation of $V_{Rk,pb}$ and $V_{Rk,c}$ see TR 054

SCELLEMENT VINYLESTERE FIXH for masonry

Performance LECA LEX harkko RUH-200 Kulma Solid
Characteristic values of resistance under tension and shear load

Annex C 40