

Pour serrure pènes A et D

For locks bolts A and D

Réf. : 2840.xx.2L20

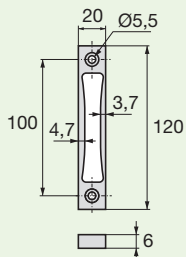

Réf. : 2840.00.0L22

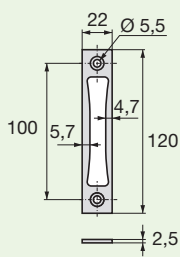

Réf. : 2840.00.0

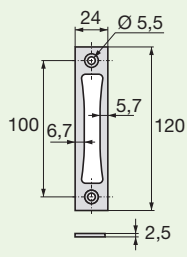

Ép. / Thickn.	Alu AS	Alu noir / Black Alu
6	2840.10.2L20	2840.17.2L20

Ép. / Thickn.	Alu AS	Alu noir / Black Alu
4	2840.10.1	2840.17.1
6	2840.10.2	2840.17.2
8	2840.10.3	2840.17.3
10	2840.10.4	2840.17.4

Pour serrure pènes i séries 6270 et 6470i

For locks bolts i series 6270 and 6470i

Réf. : 2843.00.0

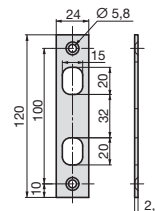

Pour serrure pènes B

For locks bolts B

Réf. : 2840.00.2B

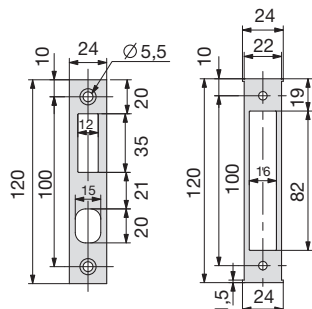

Réhausse. ép: 5 mm
Bushes. Thickness: 5 mm

Réf. : 2840.00.3B

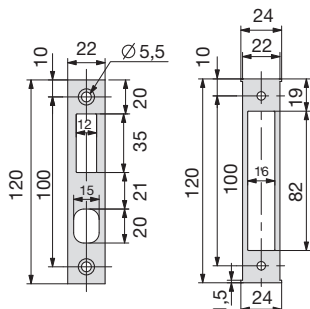

Réhausse. ép: 5 mm
Bushes. Thickness: 5 mm

Réf. : 2840.00.xA2P

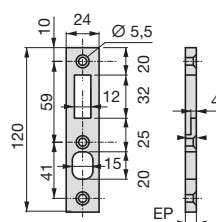

Ep.	Acier / Steel
4	2840.00.1A2P
6	2840.00.2A2P
8	2840.00.3A2P
10	2840.00.4A2P
12	2840.00.5A2P

Pour serrure pènes C

For locks bolts C

Réf. : 2840.00.1

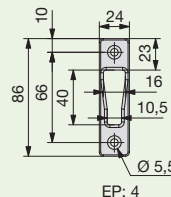

Gâches réglables pour serrure pènes B

Adjustable strikes for locks bolts B

Réf. : 2840.22.0R

Réf. : 2840.24.0RB

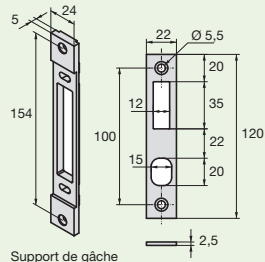
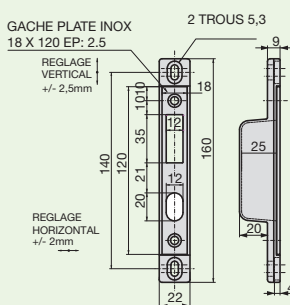

Support de gâche

Gâche réglable pour serrure pènes A ou D

Adjustable strike for locks bolts A or D

Réf. : 2840.24.0RD

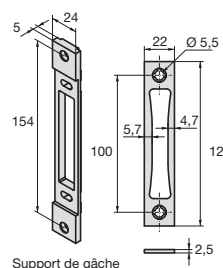

Support de gâche

Gâches haute et basse

Strikes high and low

Réf. : 2834.00.0

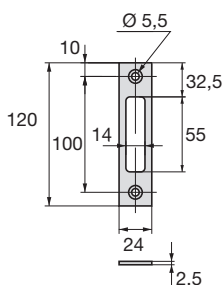

Réf. : 2834.10.4
2834.17.4

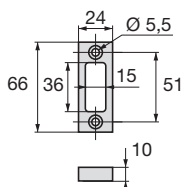

Réf. : 9954.31.0

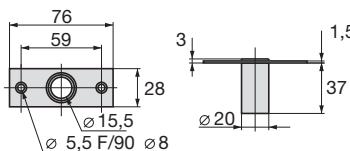

Réf. : 9954.31.3

