

ACCESSOIRES POUR PORTAILS COULISSANTS



- Codes :** P795E7V : GALET SUPPORT EXTÉRIEUR GORGE RONDE
 P79MCKM : GALET SUPPORT EXTÉRIEUR GORGE V
 P79FKE8 : GALET SUPPORT INTÉRIEUR GORGE RONDE
 P79F5IO : GALET SUPPORT INTÉRIEUR GORGE V
 P79A27O : GALET GORGE RONDE
 P798M3L : GALET GORGE V
 P79CZCL : OLIVE
 P79DQI9 / P79HBJ8 : GUIDE
 P79JPYV / P79GA2W : BUTÉES
 P796GQN : SERRURE À CROCHET
 P79LL6V : COFFRE DE SERRURE

GALET AVEC SUPPORT EXTÉRIEUR

- Galet avec support extérieur en acier zingué blanc équipé d'un roulement à billes renforcé

Code	Ø Gorge	Ø D (mm)	L	L1	A	B	C	E	Force kg*
Gorge ronde									
68 997 895	16 mm	80	120	90	16	20	40	46	200
68 997 909		100	120	90	16	20	40	56	200
68 998 018	21 mm	80	120	90	20	25	40	46	200
68 997 771		100	120	90	20	25	40	46	400
Gorge en V									
68 998 034	20 mm	80	120	90	20	25	40	46	200
68 997 844		100	120	90	20	25	40	56	400

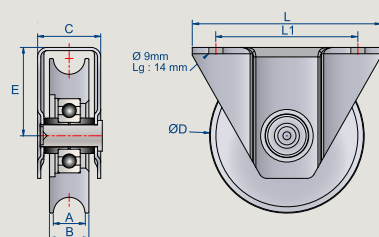

GALET AVEC SUPPORT INTÉRIEUR

- Galet avec support intérieur en acier zingué blanc équipé d'un roulement à billes renforcé
- Garde au sol réduite
- Encastrable dans un tube de 40 mm

Code	Ø Gorge	Ø D (mm)	L	L1	L2	A	B	C	D	E	Force kg*
Gorge ronde											
68 997 917	16 mm	80	138	119	98	16	20	32	52,5	25,5	200
68 997 925		100	138	119	98	16	20	32	69	35,5	200
68 997 798	21 mm	100	138	119	98	20	25	32	69	35,5	400
68 997 801		120	186	162	138	20	25	32	73,5	45,5	500
Gorge en V											
68 997 852	20 mm	100	138	119	98	20	25	32	69	35,5	400
68 997 860		120	186	162	138	20	25	32	73,5	45,5	500

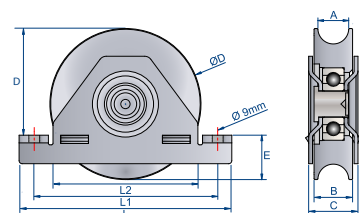
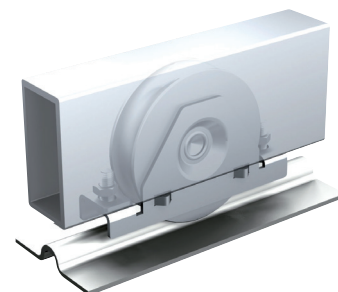

* Les forces indiquées correspondent à la charge par galet.

GALET

- Galet en acier zingué blanc équipé d'un roulement à billes renforcé

Code	Ø Gorge	Ø D (mm)	A	B	C	Dimensions de la vis	Force kg*
Gorge ronde							
68 997 879	16 mm	80	16	20	32	M 14 x 70	200
68 997 887		100	16	20	32	M 14 x 70	200
68 997 739	21 mm	100	20	25	32	M 14 x 70	400
68 997 747		120	20	25	32	M 14 x 70	500
68 997 755		140	20	25	32	M 14 x 70	550
68 997 763		160	20	25	32	M 16 x 70	700
Gorge en V							
68 998 026	20 mm	80	20	25	32	M 14 x 70	200
68 997 828		100	20	25	32	M 14 x 70	400
68 997 836		120	20	25	32	M 14 x 70	500

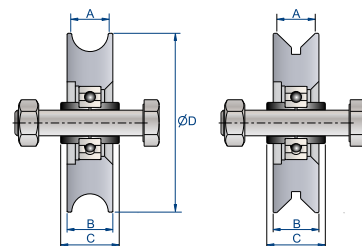

* Les forces indiquées correspondent à la charge par galet.

OLIVE NYLON

Code	A	B	C	D
68 997 941	65	25	35	14
68 997 968	80	30	40	14
68 997 976	84	40	40	14
68 997 984	102	40	60	16

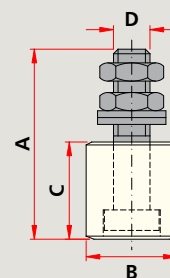

GUIDE

Code	Guide	Diamètre (mm)	Hauteur (mm)
68 997 933	Guide sans platine	50	25
68 997 992	Guide supérieur à visser	Longueur : 330 mm	

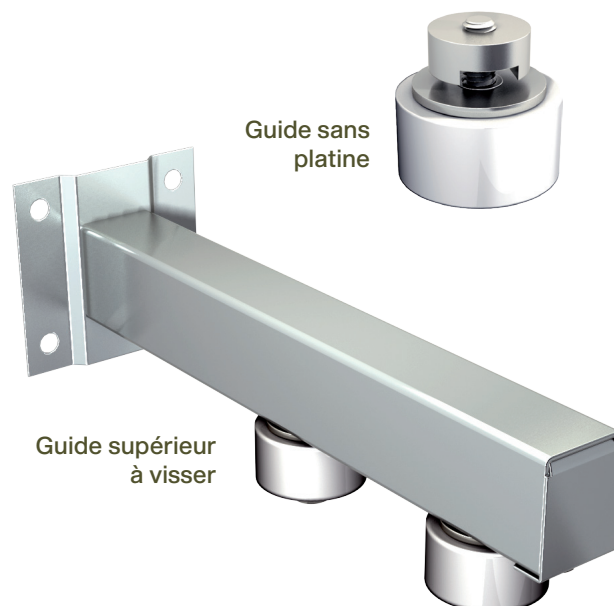
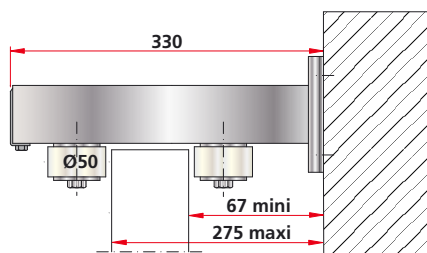

BUTÉE

- Butée en acier zingué pour portail coulissant

Code	Butée	Hauteur (mm)
68 998 042	Butée à souder	105
68 998 050	Butée à visser	105

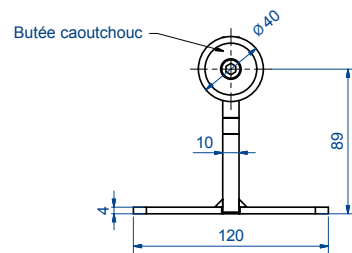
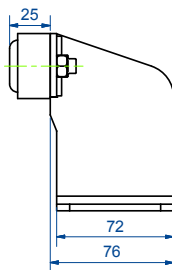
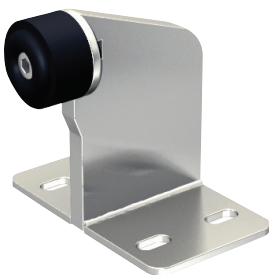
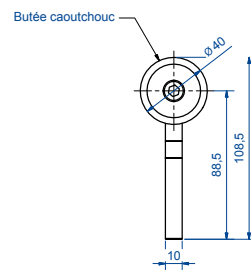
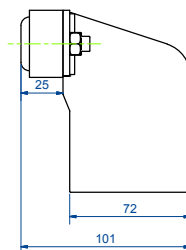

SERRURE À CROCHET

- Serrure monobloc en tôle galvanisée de 130 x 96 x 16 mm
- Entraxe : 72 mm
- Têtière de 210 x 25 x 4 mm
- Carré de 8 mm
- Pêne Ø 12 mm
- Livrée avec gâche sans cylindre

Code	A (mm)	B (mm)	C (mm)
68 998 190	96	60	174

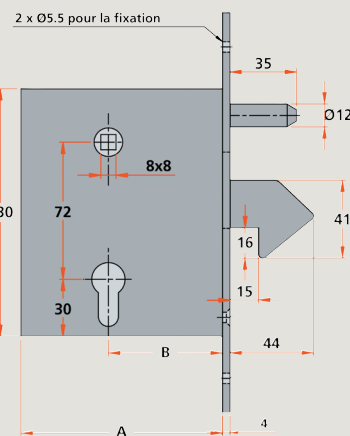
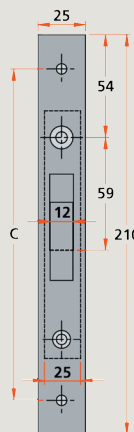

COFFRE DE SERRURE

- Acier brut
- Pour serrure à crochet monobloc
- Hauteur : 175 mm

Code	Pour tube Ø mm (C)	A (mm)	B (mm)
68 998 204	40	65	20
68 998 212	50	65	10

