

**PEDRO**

 Coffrets polyester  
étanches IP66

IP66



IK10



960°



Résistant

 Zéro  
Halogène

RoHS



UV

Une gamme complète de coffrets polyester et d'équipements pour réaliser simplement et rapidement tout type d'installation en intérieur et en extérieur pour la distribution d'énergie, la distribution de fluides, les automatismes ou les commandes et contrôles dans des environnements extrêmes (intempéries, pollution, milieu acide, milieu marin,...)

**DESCRIPTIF TECHNIQUE**

Matière première	<ul style="list-style-type: none"> <li>▪ Polyester chargé de fibres de verre</li> <li>▪ Sans halogène et sans plomb</li> </ul>
Couleur	Gris RAL 7035
UV	Excellente tenue aux UV
Tenue au température	De -50°C à +150°C
Fermeture	<ul style="list-style-type: none"> <li>▪ 2 points de fermeture (serrure à clé en option)</li> <li>▪ Serrure de sécurité triangulaire</li> </ul>
Porte	<ul style="list-style-type: none"> <li>▪ Ouverture &gt; à 180° (axe en inox)</li> <li>▪ Réversible</li> <li>▪ Livrée filmée</li> </ul>
Monobloc	<ul style="list-style-type: none"> <li>▪ Aucune pièce rapportée</li> <li>▪ Auvents haut et bas intégrés</li> </ul>
Configurations	<ul style="list-style-type: none"> <li>▪ Nombre équipement max (KIT MOD, PP et/ou GUIDA) : 3</li> <li>▪ Capacité en modules : 18 à 54</li> </ul>

**EQUIPEMENTS**

Platine perforée quick	Platine perforée	Platine pleine	Support réglable platine	Kit modulaire	Montant	Guide DIN	Plastron plein	Contreporte	Pattes de fixation standard	Pattes de fixation inox
<b>PF PERFO QUICK</b>	<b>PF PERFO</b>	<b>PF VTR</b>	<b>SCOR PF</b>	<b>KIT MOD</b>	<b>MONT</b>	<b>GUIDA</b>	<b>PP</b>	<b>CP</b>	<b>ST VTR</b>	<b>ST VTR INOX</b>
04773	04783	04766	04682	04791	04652	04661	04796	04761	04680	04688

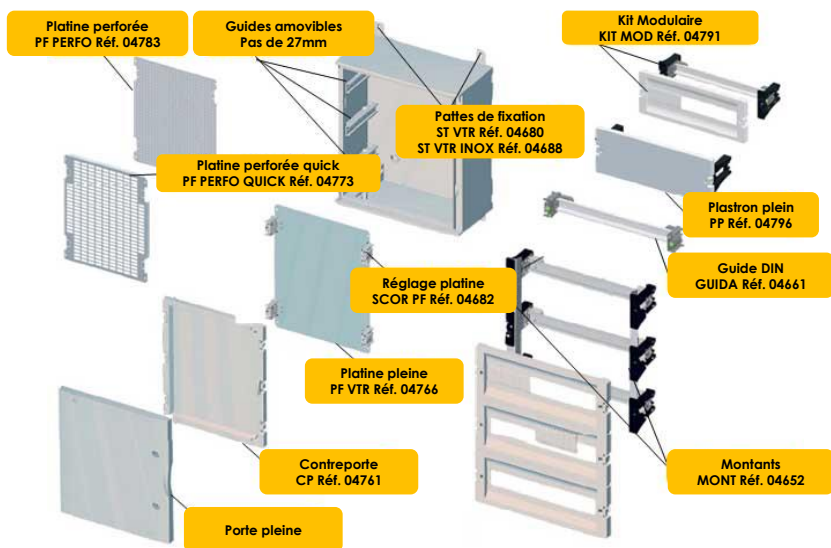
**SERRURES**

**SR VTR**

<b>SR VTR 405</b>	04740
<b>SR VTR 421</b>	04741
<b>SR VTR 455</b>	04742
<b>SR VTR 1242E</b>	04743
<b>SR VTR 2433A</b>	04744
<b>SR VTR 3113A</b>	04745

\*Toutes les serrures s'adaptent à toutes les références de coffret

**NORMES**

Certifiée EN 62208   
Autres normes de référence :  
IEC 60670-24  
IEC 60695-2-11

Expert en cheminement de l'énergie

PEDRO

Coffrets polyester  
étanches IP66



IP66



IK10



960°



Résistant



Zéro  
Halogène



RoHS



### SCHEMAS ET COTES (mm)

#### Dimensions

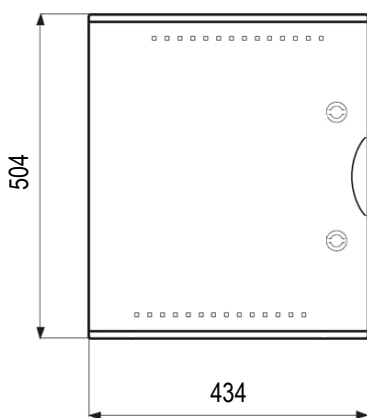

#### Profondeur

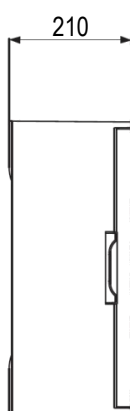

#### Entraxes de fixation

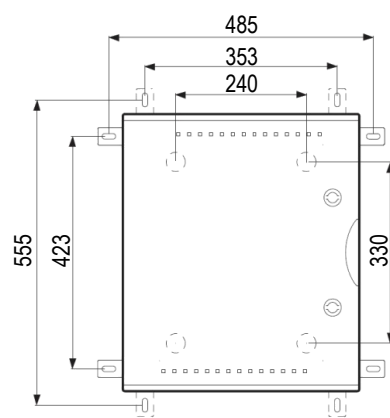

#### Platine perforée quick – PF PERFO

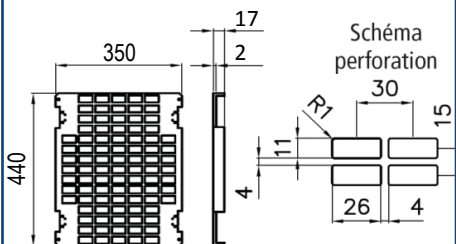

#### Platine perforée - PERFO

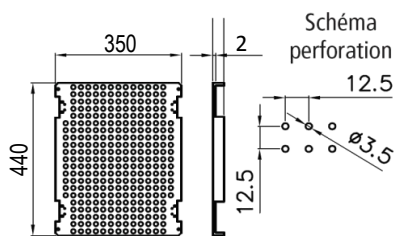

#### Platine pleine – PF VTR

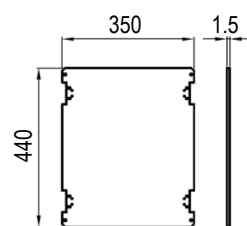

#### Contreporte- CP

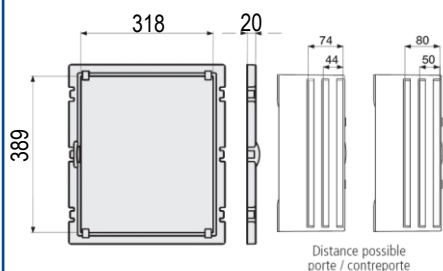

#### Kit modulaire – KIT MOD

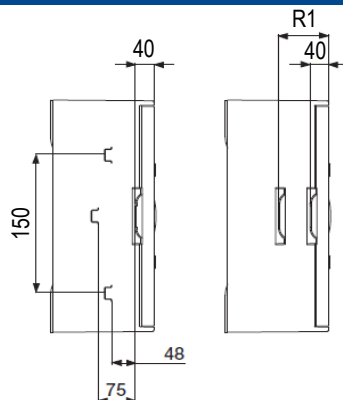

#### Pattes de fixation ST VTR/ ST VTR INOX

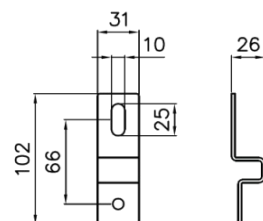

Expert en cheminement de l'énergie