

Fiche produit

Kaza

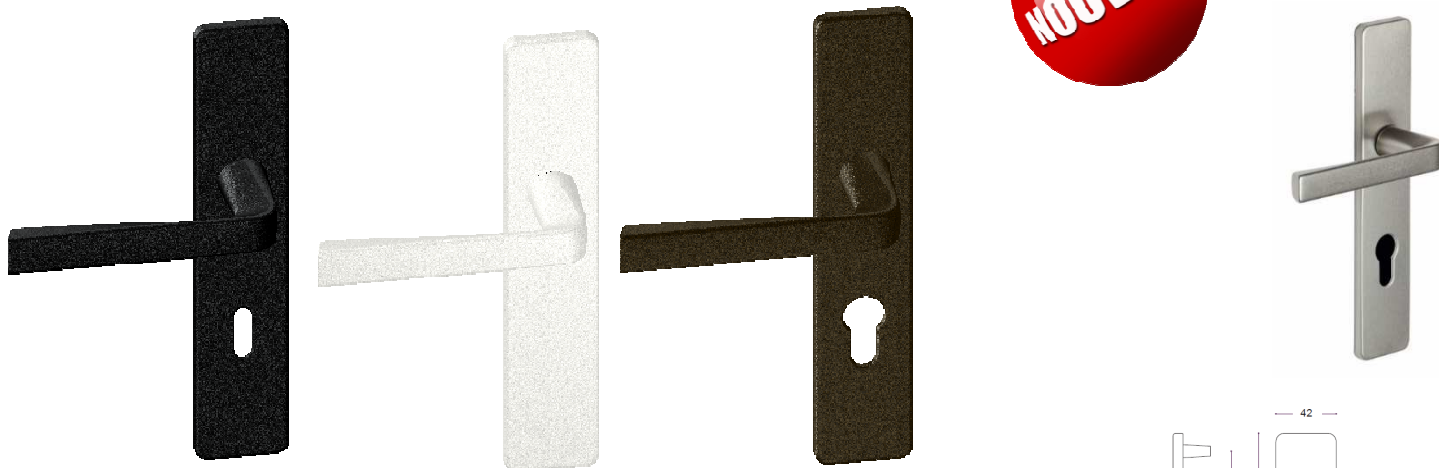



Ensemble sur grande plaque



Gamme :

- Version double béquille ou poignée de tirage côté extérieur
- Version grande ou petite plaque à coins carrés
- Perçages :
 - Clé I
 - Clé L
 - Condamnation simple
 - Condamnation à voyant
 - Bec de cane
 - SGN2

▪ Finitions :



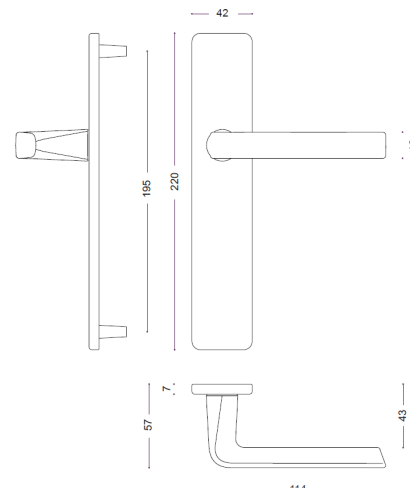





-  - Argent
-  - Anodinox
-  - BASALT : noir mat finement texturé
-  - ALBA : blanc mat finement texturé
-  - SILEX : chocolat mat finement texturé



Descriptif technique :

- Béquille en aluminium
- Ensemble monobloc : béquille et plaque solidarisées
- Plaque renforcée avec sous-plaque en polyamide chargé à 60% en fibre de verre
- Piliers taraudés intégrés et vis invisibles côté extérieur
- Carré de 7mm
- Vis de fixation M4 entraxe 195mm

Qualification selon la norme EN1906-2012

							
Catégorie d'utilisation	Endurance	Masse de la porte	Résistance au feu	Sécurité des personnes	Résistance à la corrosion	Sécurité des biens	Type d'opération
2	6	--	B	1	4	0	U



ASSA ABLOY, the global leader in door opening solutions*

*ASSA ABLOY, le leader mondial des solutions d'ouverture de portes