

# ***ENERGYLINE PRO***

**POMPE A CHALEUR POUR PISCINE  
SWIMMING POOL HEAT PUMP UNIT  
UNIDAD DE BOMBA DE CALOR PARA PISCINAS  
BOMBA DE AQUECIMENTO PARA PISCINAS  
HEIZPUMPENANLAGE FÜR EIN SCHWIMMBECKEN  
ZWEMBAD WARMTEPOMP  
UNITÀ DI RISCALDAMENTO A POMPA DI CALORE PER PISCINE  
VARMEPUMPE TIL SVØMMEBASSENG  
ТЕПЛОВОЙ НАСОС ДЛЯ ПЛАВАТЕЛЬНОГО БАСЕЙНА**



**Manuel d'instructions et d'installation  
Installation & Instruction Manual  
Manual de Instalación e Instrucciones  
Manual de instalação e de instruções  
Einbau- & Anleitungshandbuch  
Installatie- en bedieningshandleiding  
Manuale d'Uso e di Installazione  
Installerings- og brukerveiledning  
Руководство по монтажу и эксплуатации**

# SOMMAIRE

---

<b>1. Préface</b>	<b>1</b>
<hr/>	
<b>2. Caractéristiques techniques</b>	<b>2</b>
2.1 Données techniques de la pompe à chaleur	2
2.2 Plage de fonctionnement	3
2.3 Dimensions	4
<hr/>	
<b>3. Installation et raccordement</b>	<b>5</b>
3.1 Schéma de principe	5
3.2 Pompe à chaleur	6
3.3 Raccordement hydraulique	6
3.4 Raccordement électrique	7
3.5 Premier démarrage	8
3.6 Réglage du débit d'eau	10
<hr/>	
<b>4. Interface utilisateur</b>	<b>11</b>
4.1 Présentation générale	11
4.2 Réglage de l'horloge	13
4.3 Réglage de la fonction Timer	13
4.4 Choix du mode de fonctionnement	14
4.5 Réglage et visualisation du point de consigne	15
4.6 Verrouillage et déverrouillage de l'écran tactile	15
4.7 Réglage du Mode SILENCE	16
<hr/>	
<b>5. Entretien et Hivernage</b>	<b>19</b>
5.1 Entretien	19
5.2 Hivernage	19
<hr/>	
<b>6. Annexes</b>	<b>20</b>
6.1 Schémas électriques	20
6.2 Raccordements priorité chauffage	22
6.3 Vues éclatées et pièces détachées	24
6.4 Guide de dépannage	30
6.5 Garantie	32

À lire attentivement et à conserver pour une consultation ultérieure.

Ce document doit être remis au propriétaire de la piscine et doit être conservé par celui-ci en lieu sûr.

# 1. PREFACE

---

Nous vous remercions d'avoir acheté cette pompe à chaleur de piscine Hayward. Ce produit a été conçu selon des normes strictes de fabrication pour satisfaire aux niveaux de qualité requis. Le présent manuel inclut toutes les informations nécessaires concernant l'installation, l'élimination des dysfonctionnements et l'entretien. Lisez attentivement ce manuel avant d'ouvrir l'unité, ou de réaliser des opérations d'entretien sur celle-ci. Le fabricant de ce produit ne sera en aucun cas tenu responsable en cas de blessure d'un utilisateur ou d'un endommagement de l'unité suite à d'éventuelles erreurs lors de l'installation, de l'élimination des dysfonctionnements, ou d'un entretien inutile. Il est primordial de suivre à tout moment les instructions spécifiées dans ce manuel. L'unité doit être installée par un personnel qualifié.

- Les réparations doivent être effectuées par un personnel qualifié.
- Tous les raccordements électriques doivent être effectués par un électricien professionnel qualifié et selon les normes en vigueur dans le pays d'installation cf § 3.4.
- L'entretien et les différentes opérations doivent être réalisés à la fréquence et aux moments recommandés, tel que spécifié dans le présent manuel.
- N'utilisez que des pièces détachées d'origine.
- Toute recommandation non suivie annule la garantie.
- Cette pompe à chaleur réchauffe l'eau de la piscine, et maintient une température constante, ne pas l'utiliser à d'autres fins.

Après avoir lu ce manuel, rangez le en vue d'une utilisation ultérieure.  
Avertissements concernant les enfants / personnes à capacité physique réduite :

Cet appareil n'est pas destiné à être utilisé par des personnes (notamment des enfants) dont les capacités physiques, sensorielles ou intellectuelles sont réduites, ou par des personnes manquant d'expérience ou de connaissances, à moins que celles-ci ne soient sous surveillance ou qu'elles aient reçu des instructions quant à l'utilisation de l'appareil par une personne responsable de leur sécurité.

Ce produit contient des gaz à effet de serre fluorés encadrés par le protocole de Kyoto.

Type de réfrigérant : R410A

Valeur GWP<sup>(1)</sup> : 1975

Des inspections périodiques de fuite de réfrigérant peuvent être exigées en fonction de la législation européenne ou local. Veuillez contacter votre distributeur local pour plus d'informations.

---

(1) Potentiel de réchauffement global

## 2. CARACTÉRISTIQUES TECHNIQUES

---

### 2.1 Données techniques de la pompe à chaleur

Modèles	ENERGYLINE PRO	ENP6MASC	ENP6TASC	ENP7TASC
Capacité calorifique *	kW	17,8	18,2	23,4
Puissance électrique * absorbée	kW	3,69	3,7	5,15
Courant de fonctionnement *	A	16,2	7,69 / 6,89 / 6,33	9,71 / 8,01 / 7,70
Tension d'alimentation	V Ph/Hz	230V~ 50Hz	400V 3N~ 50Hz	400V 3N~ 50Hz
Calibre fusible type aM	A	20	12	16
Disjoncteur courbe D	A	20	12	16
Nombre de compresseurs		1	1	1
Type de compresseur		Scroll	Scroll	Scroll
Nombre de ventilateurs		2	2	2
Puissance du ventilateur	W	50 à 225	50 à 225	50 à 225
Vitesse de rotation des ventilateurs	RPM	600 à 950	830 à 960	800 à 1050
Ventilation		Horizontale	Horizontale	Horizontale
Niveau de pression acoustique (à 10 mètre)	dB(A)	45	45	47
Raccordement hydraulique	mm	50	50	50
Débit d'eau nominal*	m <sup>3</sup> /h	6,6	6,6	8
Perte de charge sur l'eau (max)	kPa	7	7	18
Dimensions nettes de l'unité (L/l/h)	mm	1138 / 470 / 1264	1138 / 470 / 1264	1138 / 470 / 1264
Poids net de l'unité	kg	127	123	140



\* Valeur à +/- 5% aux conditions suivantes: Température extérieur = 15°C (59°F) / HR = 71% / Température d'entrée d'eau = 26°C (78,8°F).  
Conformément au référentiel NF - 414 (Utilisation annuelle).

## 2. CARACTÉRISTIQUES TECHNIQUES (suite)

---

### 2.2 Plage de fonctionnement

Utiliser la pompe à chaleur dans les plages suivantes de températures et d'humidité pour assurer un fonctionnement sûr et efficace.

	Mode chauffage 	Mode Refroidissement 
Température extérieure	-12°C ~ +35°C	+7°C ~ +43°C
Température d'eau	+12°C ~ +40°C	+8°C ~ +40°C
Humidité relative	< 80%	< 80%
Plage de réglage point de consigne	+15°C ~ +32°C	+8°C ~ +32°C



***Si la température ou l'humidité ne correspond pas à ces conditions, des dispositifs de sécurité peuvent se déclencher et la pompe à chaleur peut ne plus fonctionner.***



***La température maximum de chauffage est limitée à +32° Celsius afin d'éviter la détérioration des liners. Hayward décline toutes responsabilités dans le cas d'une utilisation au delà des +32°C.***

## 2. CARACTERISTIQUES TECHNIQUES (suite)

### 2.3 Dimensions

Modèles : ENP6MASC / ENP6TASC / ENP7TASC

Unité : mm

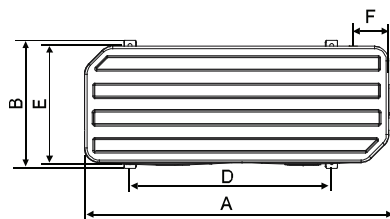
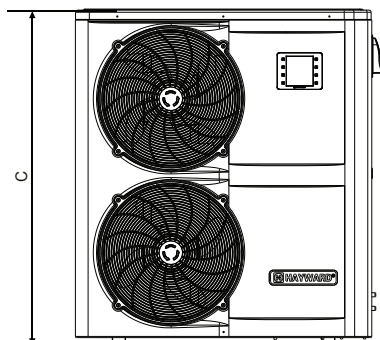
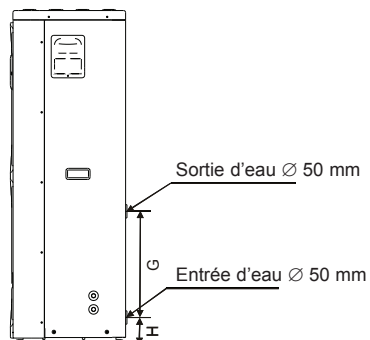

TYPE SIZE (mm)	ENP6MASC	ENP6TASC ENP7TASC
A	1138	1138
B	470	470
C	1264	1264
D	790	790
E	447	447
F	114	114
G	500	400
H	104	104

### 3. INSTALLATION ET RACCORDEMENT

#### 3.1 Schéma de Principe

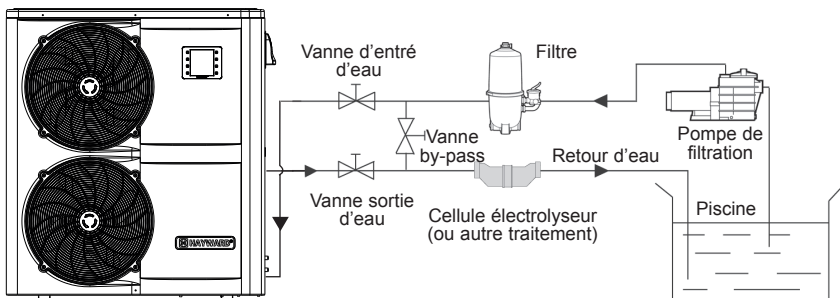

Note : La pompe à chaleur est fournie sans aucun équipement de traitement ou de filtration. Les éléments présentés sur le schéma sont des pièces à fournir par l'installateur.

#### 3.2 Pompe à chaleur



**Placer la pompe à chaleur à l'extérieur et en dehors de tout local technique fermé.**

**Placée sous abri, les distances minimum prescrites ci-dessous doivent être respectées afin d'éviter tout risque de recirculation d'air et une dégradation des performances globales de la pompe à chaleur.**

Unité : mm

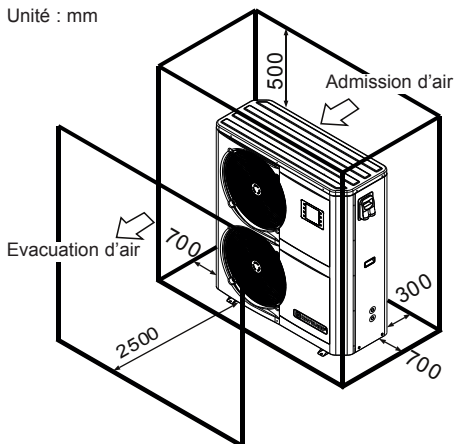

### 3. INSTALLATION ET RACCORDEMENT (suite)

---



**Installer de préférence la pompe à chaleur sur une dalle béton désolidarisée ou une chaise de fixation prévue à cet effet et monter la pompe à chaleur sur les silentblochs fournis (visserie et rondelles non fournies).**

**Distance maximale d'installation entre la pompe à chaleur et la piscine 15 mètres.**

**Longueur totale aller-retour des canalisations hydrauliques 30 mètres.**

**Isoler les canalisations hydrauliques de surface et enterrées.**

#### 3.3 Raccordement hydraulique

La pompe à chaleur est fournie avec deux raccords union diamètre 50 mm. Utiliser du tube PVC pour canalisation hydraulique Ø 50 mm. Raccorder l'entrée d'eau de la pompe à chaleur à la conduite venant du groupe de filtration puis raccorder la sortie d'eau de la pompe à chaleur à la conduite d'eau allant au bassin (cf schéma ci-dessous).

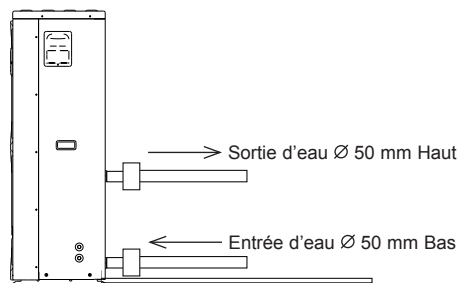

Installer une vanne dite "by-pass" entre l'entrée et la sortie de la pompe à chaleur.



**Si un distributeur automatique ou un électrolyseur est utilisé, il doit impérativement être installé après la pompe à chaleur dans le but de protéger le condenseur Titane contre une concentration trop importante de produit chimique.**



**Veillez à bien installer la vanne by-pass et les raccords union fournis au niveau de l'entrée et de la sortie d'eau de l'unité, afin de simplifier la purge durant la période hivernale, d'en faciliter l'accès ou son démontage pour l'entretien.**



### 3. INSTALLATION ET RACCORDEMENT (suite)

#### 3.4 Raccordement Électrique



**L'installation électrique et le câblage de cet équipement doivent être conformes aux règles d'installation locales en vigueur.**

F	NF C15-100	GB	BS7671:1992
D	DIN VDE 0100-702	EW	EVHS-HD 384-7-702
A	ÖVE 8001-4-702	H	MSZ 2364-702/1994/MSZ 10-553 1/1990
E	UNE 20460-7-702 1993, RECBT ITC-BT-31 2002	M	MSA HD 384-7-702.S2
IRL	Wiring Rules + IS HD 384-7-702	PL	PN-IEC 60364-7-702:1999
I	CEI 64-8/7	CZ	CSN 33 2000 7-702
LUX	384-7.702 S2	SK	STN 33 2000-7-702
NL	NEN 1010-7-702	SLO	SIST HD 384-7-702.S2
P	RSIUEE	TR	TS IEC 60364-7-702



**Vérifiez que l'alimentation électrique disponible et la fréquence du réseau correspondent au courant de fonctionnement requis, en prenant en considération l'emplacement spécifique de l'appareil, et le courant nécessaire pour alimenter tout autre appareil connecté au même circuit.**

**ENP6MASC 230 V $\sim$  +/- 10 % 50 Hz 1 Phase**

**ENP6TASC 400 V $\sim$  +/- 10 % 50 Hz 3 Phases**

**ENP7TASC 400 V $\sim$  +/- 10 % 50 Hz 3 Phases**



**Vérifier que l'équilibre des phases n'excède pas 2 %**

**Observez le schéma de câblage correspondant en annexe.**

**Le boîtier de raccordement se trouve du côté droit de l'unité. Trois connexions sont destinées à l'alimentation électrique, et deux à la commande de la pompe de filtration (Asservissement).**

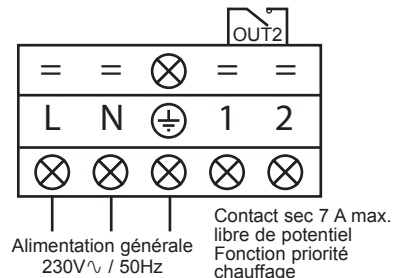
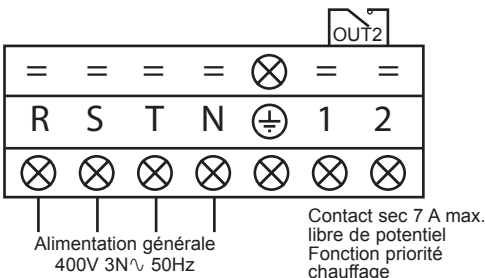

### 3. INSTALLATION ET RACCORDEMENT (suite)

---



**La ligne d'alimentation électrique doit être dotée, de manière appropriée, d'un dispositif de protection fusible de type alimentation moteur (aM) ou disjoncteur courbe D ainsi que d'un disjoncteur différentiel 30mA (voir tableau après).**

Modèles		ENP6MASC	ENP6TASC	ENP7TASC
Alimentation électrique	V/Ph/Hz	230V~/ 50Hz	400V 3N~/ 50Hz	400V 3N~/ 50Hz
Calibre fusible type aM	A	20 aM	12 aM	16 aM
Disjoncteur courbe D	A	20 D	12 D	16 D
Section de câble	mm <sup>2</sup>	3G6 3 x 6	5G2,5 5 x 2,5	5G2,5 5 x 2,5



**Utiliser un câble d'alimentation Type RO2V/R2V ou équivalent.**



**Les sections de câble sont données pour une longueur maximum de 25 m, elles doivent néanmoins être vérifiées et adaptées en fonction des conditions d'installation.**



**Prenez toujours garde d'arrêter l'alimentation principale avant d'ouvrir la boîte de commande électrique.**

#### 3.5 Premier démarrage

Procédure de démarrage - une fois l'installation terminée, suivez et respectez les étapes suivantes :

- 1) Faites pivoter les ventilateurs à la main afin de vérifier qu'il peut tourner librement, et que l'hélice est fixée correctement sur l'arbre du moteur.
- 2) Assurez-vous que l'unité est connectée correctement à l'alimentation principale (voir le schéma de câblage en annexe).
- 3) Activez la pompe de filtration.
- 4) Vérifiez que toutes les vannes d'eau sont ouvertes, et que l'eau s'écoule vers l'unité avant de passer en mode chauffage ou refroidissement.
- 5) Vérifiez que le tuyau de purge des condensats est fixé correctement, et ne présente aucune obstruction.
- 6) Activez l'alimentation électrique destinée à l'unité, puis appuyez sur le bouton Marche/Arrêt  sur le panneau de commande.
- 7) Assurez-vous qu'aucun code d'ALARME ne s'affiche lorsque l'unité est sur ON (voir guide de dépannage).

### 3. INSTALLATION ET RACCORDEMENT (suite)

- 8) Fixez le débit d'eau à l'aide de la vanne by-pass (voir § 3.6 et 2.1), tel que prévu respectivement pour chaque modèle, de manière à obtenir une différence de température Entrée/Sortie de 2°C.
- 9) Après un fonctionnement de quelques minutes, vérifiez que l'air sortant de l'unité s'est refroidi (entre 5 et 10°).
- 10) L'unité étant en service, désactivez la pompe de filtration. L'unité doit s'arrêter automatiquement et afficher le code d'erreur E03.
- 11) Faites fonctionner l'unité et la pompe de la piscine 24 heures sur 24, jusqu'à ce que la température de l'eau souhaitée soit atteinte. Quand la température d'entrée d'eau atteint la valeur de consigne, l'unité s'arrête. Elle redémarre alors automatiquement (tant que la pompe de la piscine est en service) si la température de la piscine est inférieure d'au moins 0.5°C à la température de consigne.

**Contrôleur de débit** - L'unité est dotée d'un contrôleur de débit qui active la pompe à chaleur lorsque la pompe de filtration de la piscine est en service, et la désactive lorsque la pompe de la filtration est hors service. Par manque d'eau, le code d'alarme E03 s'affiche sur le régulateur (Voir § 6.4).

**Temporisation** - l'unité intègre une temporisation de 3 minutes, afin de protéger les composants du circuit de commande, d'éliminer toute instabilité en terme de redémarrage et, toute interférence au niveau du contacteur. Grâce à cette temporisation, l'unité redémarre automatiquement 3 minutes environ après toute coupure du circuit de commande. Même une coupure de courant de courte durée active la temporisation de démarrage.

**Contrôleur de phase** - Les unités Triphasés intègre un contrôleur de phase pour garantir le bon sens de rotation du compresseur. Si l'unité ne démarre pas, vérifier l'état du contrôleur de phase situé dans le coffret électrique.

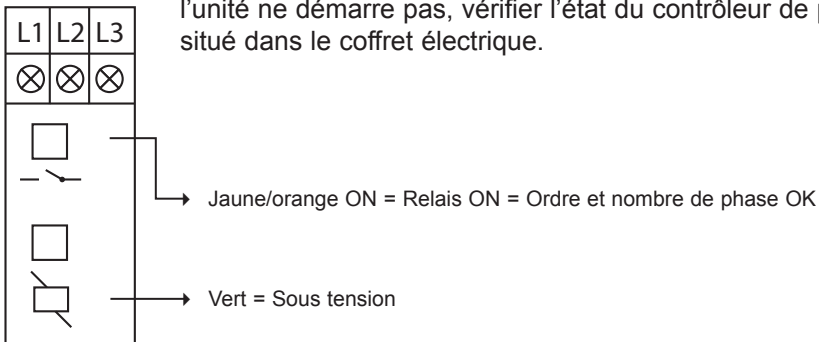

### 3. INSTALLATION ET RACCORDEMENT (suite)

#### 3.6 Réglage du débit d'eau

Les vannes d'entrée et de sortie d'eau étant ouvertes, ajuster la vanne dite "by-pass" de façon à obtenir une différence de 2°C entre la température d'entrée et de sortie d'eau (voir schéma de principe § 3.1). Vous pouvez vérifier le réglage en visualisant les températures entrée/sortie directement sur le panneau de commande.

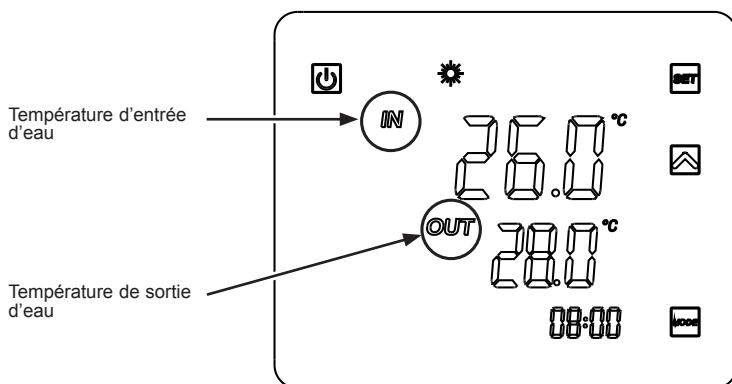

Note : L'ouverture de la vanne dite "by-pass" engendre un débit moins important d'ou une augmentation du  $\Delta T$ .

La fermeture de la vanne dite "by-pass" engendre un débit plus important d'ou une diminution du  $\Delta T$ .

## 4. INTERFACE UTILISATEUR

### 4.1 Présentation générale

La pompe à chaleur est équipée d'un panneau de commande digital à écran tactile, raccordé électriquement et pré-réglé en usine en mode chauffage.

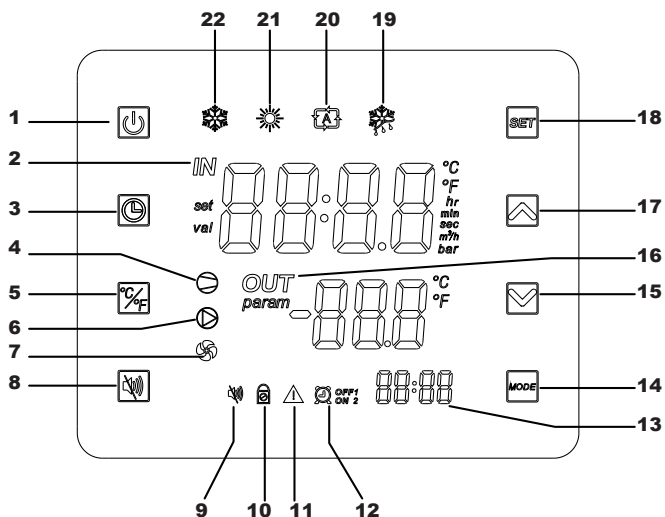

#### Légende

1		Marche / Arrêt
2	<i>IN</i>	Entrée d'eau
3		Réglage heure et Timers
4		Compresseur ON
5		Conversion °C/°F
6		Contact sec OUT2
7		Ventilateur ON
8		Mode silence
9		Témoin mode silence
10		Écran verrouillé
11		Alarme

12		Timers 1 et 2
13		Heure des Timers
14	<b>MODE</b>	Sélection du mode
15		Défilement bas / Diminuer
16	<i>OUT</i>	Sortie d'eau
17		Défilement haut / Augmenter
18	<b>SET</b>	Sauvegarde / Réglages
19		Mode dégivrage
20		Mode automatique
21		Mode chauffage
22		Mode refroidissement

## 4. INTERFACE UTILISATEUR (suite)

---

### Mode OFF

Lorsque la pompe à chaleur est en veille (Mode OFF) l'inscription "OFF" est affichée sur l'écran du régulateur.

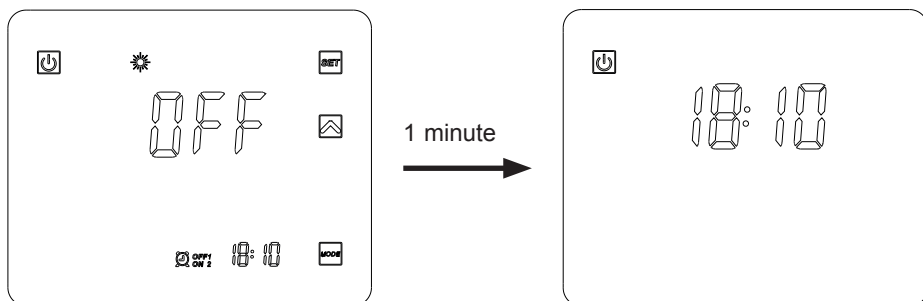

### Mode ON

Lorsque la pompe à chaleur est en fonctionnement ou en régulation (Mode ON) les températures d'entrée et de sortie d'eau sont affichées sur l'écran du régulateur.

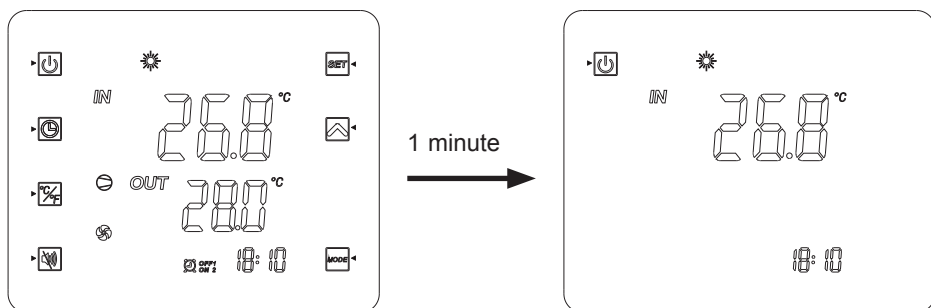











## 4. INTERFACE UTILISATEUR (suite)

A la fin des réglages, presser sur  pour valider.

L'enregistrement des réglages est automatique au bout de 20s sans action.

### 4.2 Réglage de l'horloge

Si l'afficheur est en mode veille, appuyer brièvement sur le bouton .









- 1) Presser sur  pour faire apparaître le symbole .
- 2) Presser sur , l'affichage de l'heure clignote. Régler les heures à l'aide des boutons  .
- 3) Presser sur  puis régler les minutes à l'aide des boutons  .
- 4) Valider en pressant sur .

### 4.3 Réglage de la fonction Timer











Le réglage de cette fonction est nécessaire dès lors que vous souhaitez faire fonctionner votre pompe à chaleur sur une plus courte période que celle définie par l'horloge de filtration. Ainsi vous pourrez programmer un départ différé et un arrêt anticipé ou simplement interdire une plage horaire de fonctionnement (par exemple la nuit).



Vous avez la possibilité de programmer 2 Timers Départ (ON1 et ON2) et 2 Timers Arrêt (OFF1 et OFF2).

#### Programmation du Timer 1 – Départ

- 1) Presser  pendant 2s, le Timer ON1  clignote (\*).
- 2) Presser sur  pour régler les heures à l'aide des boutons  .
- 3) Presser sur  pour régler les minutes à l'aide des boutons  .
- 4) Valider en pressant sur .



#### Programmation du Timer 1 – Arrêt

- 1) Presser  pendant 2s, le Timer ON1  clignote (\*).  
Presser 1 fois sur , le Timer OFF1  clignote.
- 2) Presser sur  pour régler les heures à l'aide des boutons  .
- 3) Presser sur  pour régler les minutes à l'aide des boutons  .
- 4) Valider en pressant sur .



(\*) Pour accéder directement au Timer ON2 , presser  pendant 2s, puis presser 2 fois sur .

## 4. INTERFACE UTILISATEUR (suite)













### Programmation du Timer 2

Après les réglages du Timer 1, vous accédez directement aux réglages du Timer 2 :  et .

Procédez de la même façon que pour le Timer 1.

**Nota:** Pour accéder directement au Timer ON2 , presser  pendant 2s, puis presser 2 fois sur .

### Suppression des Timers (Départ et Arrêt)

- 1) Presser  pendant 2s, le Timer  clignote.(\*)
- 2) Presser sur , l'affichage de l'heure clignote.
- 3) Presser sur  pour supprimer le Timer .
- 4) Presser  pour valider.
- 5) Presser  pendant 2s, le Timer  clignote.  
Presser 1 fois sur , le Timer  clignote.(\*)
- 6) Presser sur , l'affichage de l'heure clignote.
- 7) Presser sur  pour supprimer le Timer .

(\*) Pour accéder aux Timers 2  ou , suivre les étapes 1) à 4) puis appuyer 2 fois sur . Procéder de la même façon que ci-dessus.

### 4.4 Choix du mode de fonctionnement : Refroidissement, Chauffage ou Automatique

#### En Mode "OFF" ou "ON"

Presser le bouton  pour changer de mode : refroidissement, chauffage ou automatique.

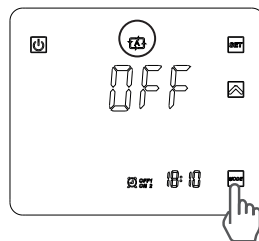
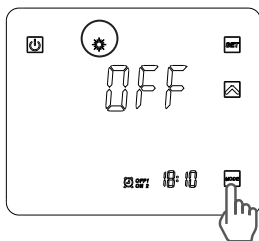
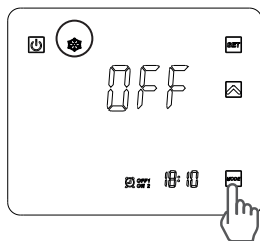



**Si la pompe à chaleur est réglée en mode Chaud Seul ou Froid Seul, le changement de mode n'est pas valide.**





## 4. INTERFACE UTILISATEUR (suite)

### 4.5 Réglage et visualisation du point de consigne (Température d'eau souhaitée)

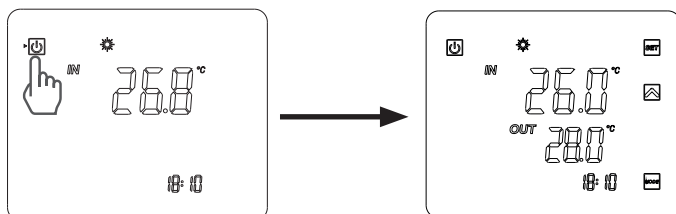
Si le bouton  n'est pas visible à l'écran, appuyer brièvement sur .  
(En fonctionnement ou à l'arrêt, il suffit de presser le bouton  pour visualiser le point de consigne.)





#### En Mode "OFF" et Mode "ON"



Presser le bouton  pour afficher le point de consigne, puis presser sur  ou  pour définir le point de consigne souhaité.  
Le réglage s'effectue avec une précision de 0,5 °C.



***Il est recommandé de ne jamais dépasser la température de 30°C pour éviter l'altération des liners.***

### 4.6 Verrouillage et déverrouillage de l'écran tactile

Presser le bouton  pendant 5s jusqu'à l'émission d'un bip et l'apparition du symbole .

Pour déverrouiller, presser  pendant 5s jusqu'à l'émission d'un bip et la disparition du symbole .

## 4. INTERFACE UTILISATEUR (suite)

### 4.7 Réglage de la fonction SILENCE (🔇)

Cette fonction permet l'utilisation de la pompe à chaleur sous une vitesse de rotation des ventilateurs réduite à 600Tr/min pour le ENP6MASC, 830Tr/min pour le ENP6TASC et 800Tr/min pour le ENP7TASC pendant une durée de 8 heures maximum, ceci afin de limiter les nuisances sonores en période nocturne et ou diurne selon la localisation de la pompe à chaleur par rapport au voisinage et ou du bassin.



Cette fonction peut être Activée/Désactivée soit manuellement, soit à l'aide d'un Timer.

#### Activation Manuelle

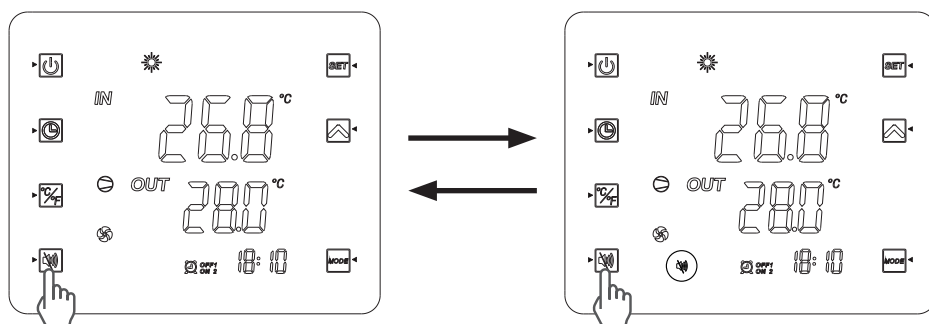
- 1) Appuyer sur le bouton .
- 2) L'affichage ci-dessous apparaît à l'écran, le mode Silence est activé pour les 8 prochaines heures.
- 3) Les ventilateurs réduisent progressivement leur vitesse de rotation pour une durée de 8 heures maximum.
- 4) Après 8 heures de fonctionnement la fonction sera automatiquement désactivée et les ventilateurs reprendront une vitesse de rotation en fonction de la température de l'air extérieure.





#### Désactivation Manuelle

- 1) Appuyer sur le bouton .
- 2) Le témoin  disparaît de l'écran : le mode Silence est désactivé.
- 3) Les ventilateurs ajustent leur vitesse de rotation en fonction de la température de l'air extérieur.

# 4. INTERFACE UTILISATEUR (suite)



## Programmation du mode SILENCE

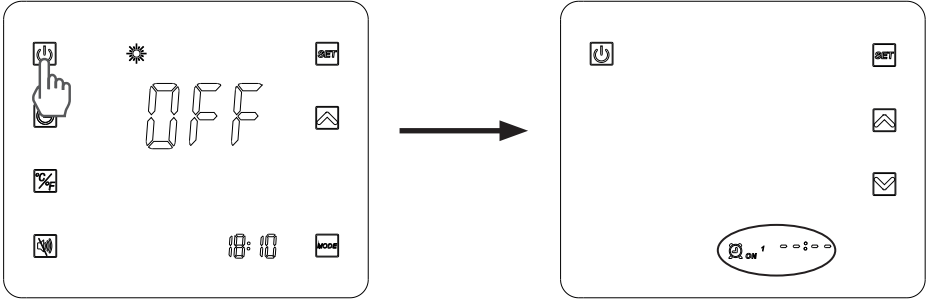

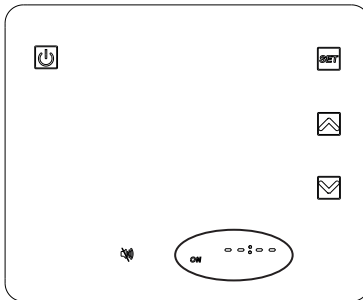

1) Presser  pendant 2s : le Timer ON1  ON <sup>1</sup> clignote.



2) Presser 4 fois sur  jusqu'à l'écran ci-dessous.



3) Presser sur , l'affichage des heures clignote. Utiliser les flèches   pour régler l'heure du début.





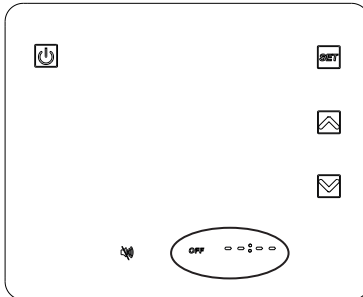



4) Presser sur , l'affichage des minutes clignote. Utiliser les flèches   pour régler les minutes du début. Valider en pressant sur .

5) Presser sur  pour régler l'heure de fin : l'indication **OFF** clignote.



## 4. INTERFACE UTILISATEUR (suite)

---

- 6) Presser sur , l'affichage des heures clignote. Utiliser les flèches   pour régler l'heure de fin.
- 7) Presser sur , l'affichage des minutes clignote. Utiliser les flèches   pour régler les minutes de fin. Valider en pressant sur .
- 8) Presser  pour revenir à l'écran précédent.  
Les indications ON-OFF s'affichent comme ci-dessous.

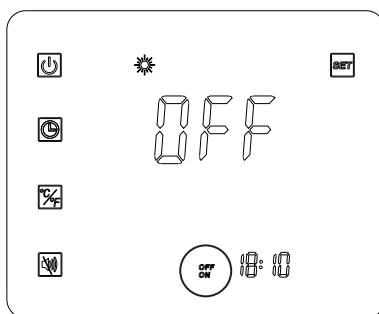

**Nota :** Le pas de réglage des minutes est de 10 en 10.

Une fois le réglage du mode SILENCE terminé, celui-ci est actif par défaut 7j/7j.

## 5. ENTRETIEN ET HIVERNAGE

---

### 5.1 Entretien

Ces opérations de maintenance doivent être réalisées 1 fois par an afin de garantir la longévité et le bon fonctionnement de la pompe à chaleur.

- Nettoyer l'évaporateur à l'aide d'une brosse souple ou d'un jet d'air ou d'eau (**Attention ne jamais utiliser un nettoyeur haute pression**).
- Vérifier le bon écoulement des condensats.
- Vérifier le serrage des raccords hydrauliques et électriques
- Vérifier l'étanchéité hydraulique du condenseur.



***Avant toute opération de maintenance la pompe à chaleur doit être déconnectée de toute source de courant électrique. Les opérations de maintenance doivent être réalisées uniquement par un personnel qualifié et habilité à manipuler les fluides frigorigènes.***

### 5.2 Hivernage

- Mettre la pompe à chaleur en Mode "OFF".
- Couper l'alimentation de la pompe à chaleur.
- Vider le condenseur à l'aide de la vidange pour éviter tout risque de dégradation. (risque important de gel).
- Fermer la vanne "by-pass" et dévisser les raccords unions entrée/sortie.
- Chasser au maximum l'eau stagnante résiduelle du condenseur à l'aide d'un pistolet à air.
- Obturer l'entrée et la sortie d'eau sur la pompe à chaleur pour éviter l'intrusion de corps étranger.
- Couvrir la pompe à chaleur avec la housse d'hivernage prévue à cet effet.



***Tout dommage occasionné par un mauvais hivernage entraîne l'annulation de la garantie.***

# 6. ANNEXES

## 6.1 Schémas électriques

### ENP6MASC

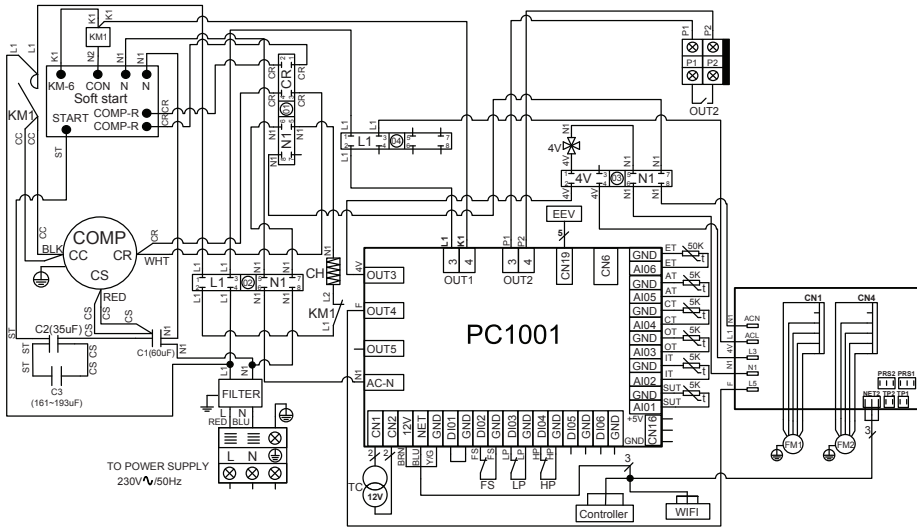

**REMARQUES :**

- 1. AT : SONDE DE TEMPÉRATURE D'AIR
- 2. COMP : COMPRESSEUR
- 3. CT : SONDE TEMPÉRATURE ÉVAPORATEUR
- 4. EEV : DÉTENDEUR ÉLECTRONIQUE
- 5. FM1-2 : MOTEUR VENTILATEUR
- 6. FS : DÉTECTEUR PRÉSENCE D'EAU
- 7. HP : PRESSOSTAT HAUTE PRESSION
- 8. IT : SONDE DE TEMPÉRATURE ENTRÉE D'EAU
- 9. LP : PRESSOSTAT BASSE PRESSION

- 10. OT : SONDE DE TEMPÉRATURE SORTIE D'EAU
- 11. SUT : SONDE DE TEMPÉRATURE D'ASPIRATION
- 12. TC : TRANSFORMATEUR 230V~ / 12V~
- 13. 4V : VANNE 4 VOIES
- 14. KM1 : CONTACTEUR DE PUISSANCE
- 15. SOFT START : DÉMARREUR ÉLECTRONIQUE
- 16. CH : RÉSISTANCE DE CARTER
- 17. OUT2 : CONTACT SEC MAX. 7 A
- 18. ET : SONDE DE TEMPÉRATURE REFOULEMENT

# ENP6TASC - ENP7TASC

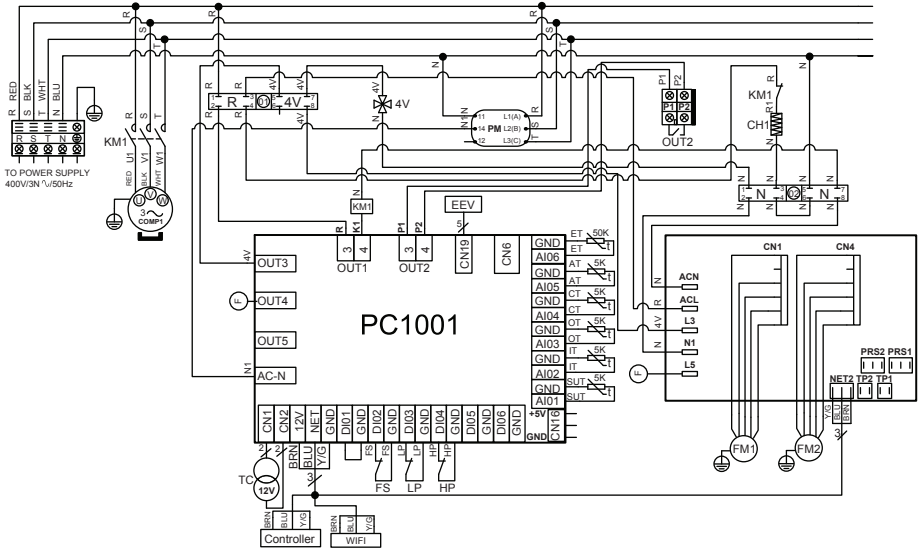

**REMARQUES :**

- 1. AT : SONDE DE TEMPÉRATURE D'AIR
- 2. COMP : COMPRESSEUR
- 3. CT : SONDE TEMPÉRATURE ÉVAPORATEUR
- 4. EEV : DÉTENDEUR ÉLECTRONIQUE
- 5. FM1-2 : MOTEUR VENTILATEUR
- 6. FS : DÉTECTEUR PRÉSENCE D'EAU
- 7. HP : PRESSOSTAT HAUTE PRESSION
- 8. IT : SONDE DE TEMPÉRATURE ENTRÉE D'EAU
- 9. LP : PRESSOSTAT BASSE PRESSION

- 10. OT : SONDE DE TEMPÉRATURE SORTIE D'EAU
- 11. SUT : SONDE DE TEMPÉRATURE D'ASPIRATION
- 12. TC : TRANSFORMATEUR 230V~ / 12V~
- 13. 4V : VANNE 4 VOIES
- 14. KM1 : CONTACTEUR DE PUISSANCE
- 15 : PM : CONTRÔLEUR DE PHASE
- 16 : CH1 : RÉSISTANCE DE CARTER
- 17. OUT2 : CONTACT SEC MAX. 7 A
- 18. ET : SONDE DE TEMPÉRATURE REFOULEMENT

## 6. ANNEXES (suite)

### 6.2 Raccordements priorité chauffage Pompe Monophasé

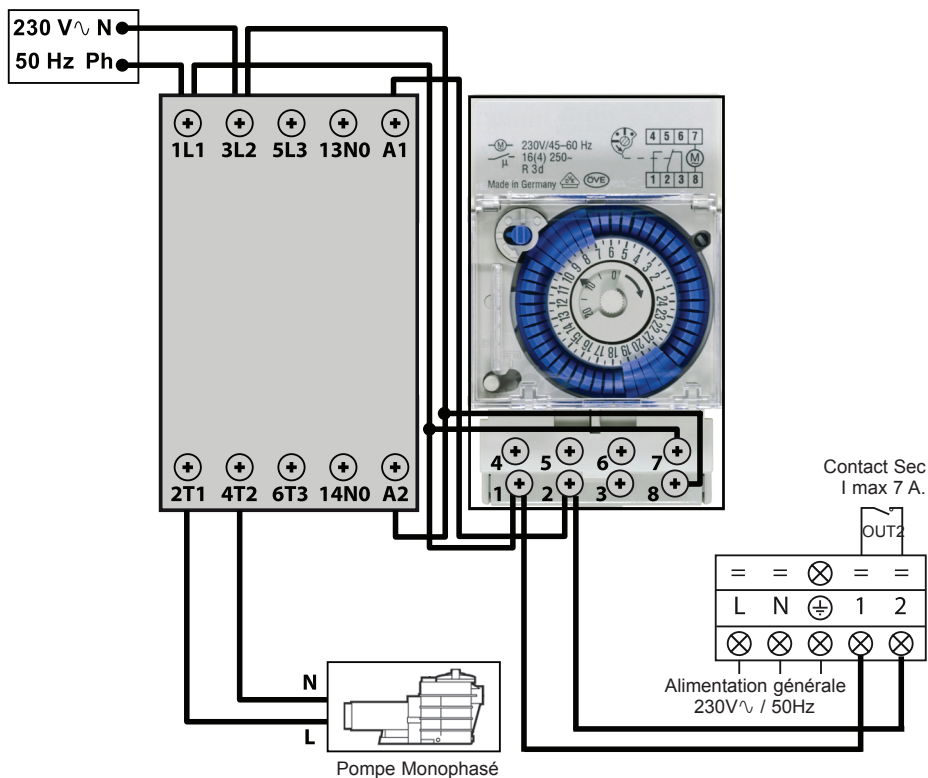

Les bornes 1-2 délivrent un contact sec libre de potentiel, sans polarité 230 V $\sim$  / 50 Hz.  
Câbler les bornes 1 et 2 en respectant le câblage indiqué ci-dessus afin d'asservir le fonctionnement de la pompe de filtration par cycle de 2 min. toutes les heures si la température du bassin est inférieure au point de consigne.

 Ne jamais raccorder l'alimentation de la pompe de filtration directement sur les bornes 1 et 2.





## 6. ANNEXES (suite)

### 6.2 Raccordements priorité chauffage Pompe Triphasé

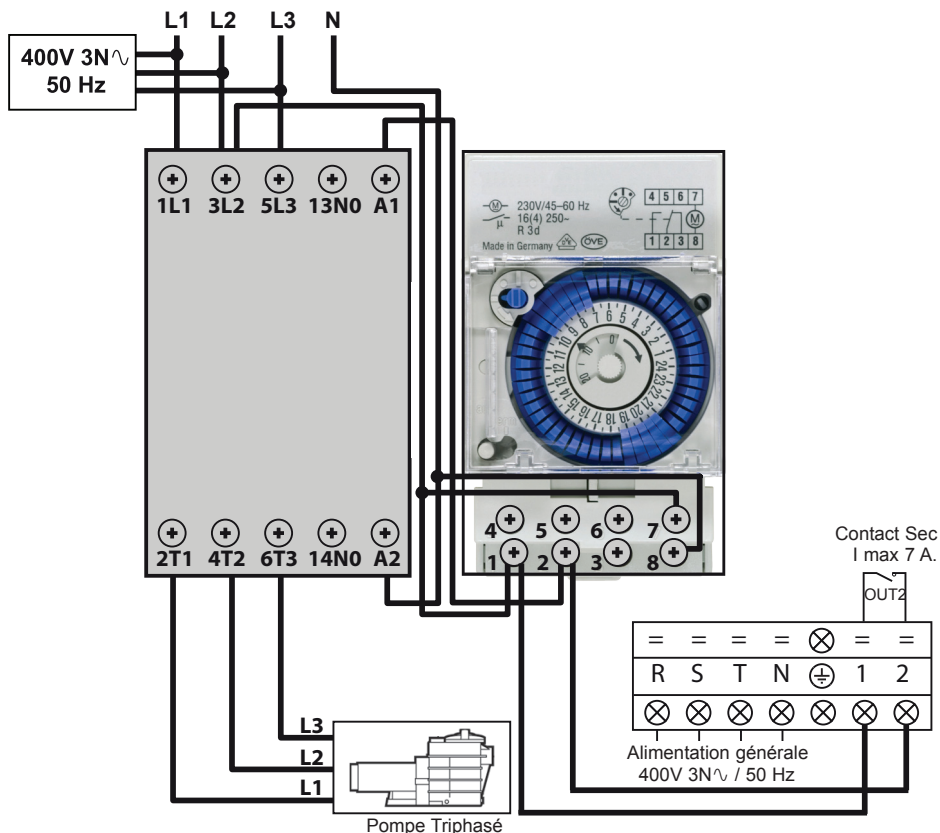

Les bornes 1-2 délivrent un contact sec libre de potentiel, sans polarité 230 V $\sim$  / 50 Hz.  
Câbler les bornes 1 et 2 en respectant le câblage indiqué ci-dessus afin d'asservir le fonctionnement de la pompe de filtration par cycle de 2 min. toutes les heures si la température du bassin est inférieure au point de consigne.

 Ne jamais raccorder l'alimentation de la pompe de filtration directement sur les bornes 1 et 2.



## 6. ANNEXES (suite)

### 6.3 Vues éclatées et pièces détachées

#### ENP6MASC

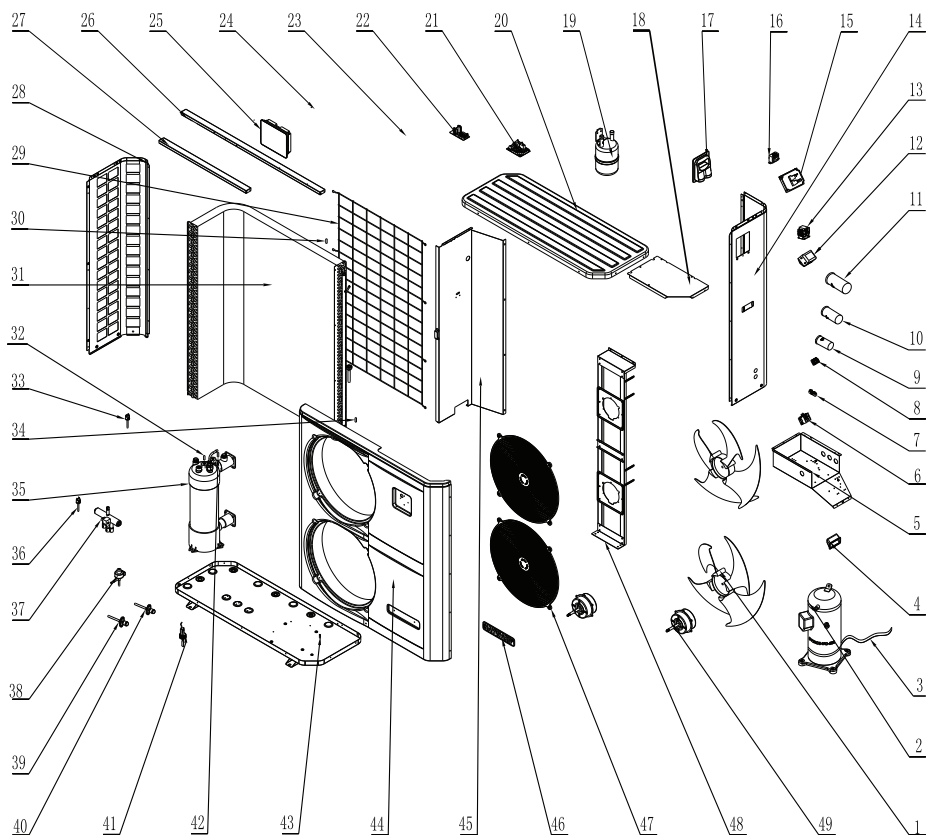

## 6. ANNEXES (suite)

### ENP6MASC

Rep	Réf.	Désignation	Rep	Réf.	Désignation
1	HWX20000270004	Hélice ventilateur	28	HWX32019210028	Panneau gauche
2	HWX200011112	Compresseur	29	HWX32019210031	Protection Évaporateur
3	HWX20003214	Résistance de Carter	30	HWX20003242	Sonde température d'air
4	HWX32008220037	Poignée	31	HWX32010120008	Évaporateur
5	HWX32019210040	Coffret électrique	32	HWX20003242	Sonde d'entrée d'eau
6	HWX20003920	Bornier 3 connexions Alim	33	HWX20013605	Pressostat haute pression
7	HWX20003909	Bornier 2 connexions	34	HWX20003242	Sonde température évaporateur
8	HWX20003933	Bornier 3 connexions	35	HWX32010120023	Condenseur Titane PVC
9	HWX20003504	Condensateur compresseur (35µF)	36	HWX20003603	Pressostat basse pression
10	HWX20003510	Condensateur compresseur (60µF)	37	HWX20011491	Vanne 4 voies
11	HWX20000350011	Condensateur de démarrage (193µF)	38	HWX20000140346	Détendeur électronique
12	HWX20003254	Filtre CEM	39	HWX20000140353	Prise de pression HP&BP
13	HWX200036007	Contacteur Compresseur Mono	40	HWX20000140353	Prise de pression HP&BP
14	HWX32010210013	Panneau droit	41	HWX200036005	Détecteur de débit d'eau
15	HWX20003151	Démarreur électronique	42	HWX20003242	Sonde de sortie d'eau
16	HWX200037003	Transformateur 230V $\sqrt{\quad}$ - 12V $\sqrt{\quad}$	43	HWX32019210061	Fond
17	HWX32009220032	Trappe d'accès électrique	44	HWX32019210049	Panneau avant
18	HWX32019210025	Panneau de protection électrique	45	HWX32019210026	Panneau de séparation
19	HWX20001440	Réservoir de liquide	46	HWX20000230596	Logo Hayward
20	HWX32019220001	Panneau supérieur	47	HWX20000220169	Grille de protection ventilateur
21	HWX95053114512E	Carte électronique	48	HWX32019210022	Support Moteur
22	HWX950531024103	Module DC Inverter	49	HWX20000330132	Moteur DC
*23*	HWX20003223	Sonde compresseur 50kΩ	*50*	HWX20002625	Silent bloc
24	/	/	*51*	HWX200026009	Joint torique ID 48-Ep 5mm
25	HWX95005010018	Régulateur LED	*52*	HWX200026061	joint torique ID 43-Ep 3.4mm
26	HWX32019210030	Raidisseur Large	*53*	HWX20000240112	Couverture d'hivernage
27	HWX32019210029	Raidisseur Petit	*54*	HWX20001345	Bouchon de vidange

Nota : Les repères \*xx\* ne sont pas référencés sur la vue éclatée correspondante.

## 6. ANNEXES (suite)

### ENP6TASC

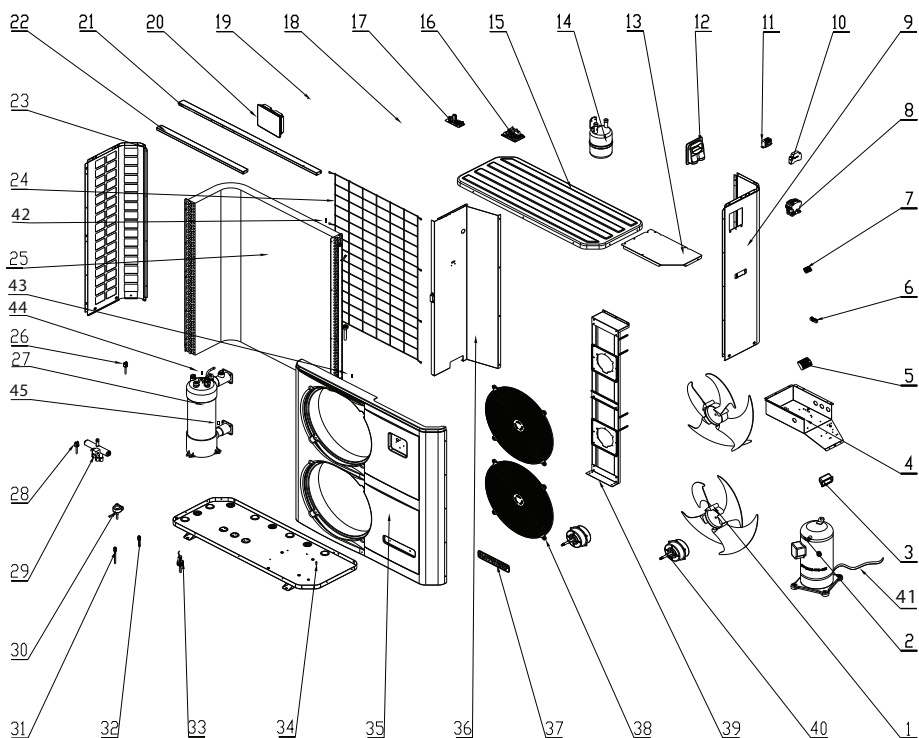

## 6. ANNEXES (suite)

### ENP6TASC

Rep	Réf.	Désignation	Rep	Réf.	Désignation
1	HWX20000270004	Hélice ventilateur	26	HWX20013605	Pressostat haute pression
2	HWX20000110146	Compresseur	27	HWX32019120007	Condenseur Titane PVC
3	HWX32008220037	Poignée	28	HWX20003603	Pressostat basse pression
4	HWX32019210024	Coffret électrique	29	HWX20011491	Vanne 4 voies
5	HWX20003902	Bornier 5 connexions Tri	30	HWX20000140346	Détendeur électronique
6	HWX20003909	Bornier 2 connexions	31		
7	HWX20003933	Bornier 3 connexions	32		
8	HWX20003653	Contacteur Compresseur TRI	33	HWX200036005	Détecteur de débit d'eau
9	HWX32019210027	Panneau droit	34	HWX32019210061	Fond
10	HWX200036023	Contrôleur de phase	35	HWX32019210049	Panneau avant
11	HWX200037003	Transformateur 230V $\surd$ - 12V $\surd$	36	HWX32019210026	Panneau de séparation
12	HWX32009220032	Trappe d'accès électrique	37	HWX20000230596	Logo Hayward
13	HWX32019210025	Panneau de protection électrique	38	HWX20000220169	Grille de protection ventilateur
14	HWX20001440	Réservoir de liquide	39	HWX32019210022	Support Moteur
15	HWX32019220001	Panneau supérieur	40	HWX20000330132	Moteur DC
16	HWX95053114510E	Carte électronique	41	HWX20003214	Résistance de Carter
17	HWX950531024101	Module DC Inverter	42		Sonde température d'air
*18*	HWX20003223	Sonde compresseur 50k $\Omega$	43		Sonde température évaporateur
19	/	/	44	HWX20003242	Sonde d'entrée d'eau
20	HWX95005010018	Régulateur LED	45		Sonde de sortie d'eau
21	HWX32019210030	Raidisseur Large	*46*	HWX20002625	Silent bloc
22	HWX32019210029	Raidisseur Petit	*47*	HWX200026009	Joint torique ID 48-Ep 5mm
23	HWX32019210028	Panneau gauche	*48*	HWX200026061	Joint torique ID 43-Ep 3.4mm
24	HWX32019210031	Protection Évaporateur	*49*	HWX20000240112	Couverture d'hivernage
25	HWX32010120008	Évaporateur	*50*	HWX20001345	Bouchon de vidange

Nota : Les repères \*xx\* ne sont pas référencés sur la vue éclatée correspondante.

## 6. ANNEXES (suite)

---

### ENP7TASC

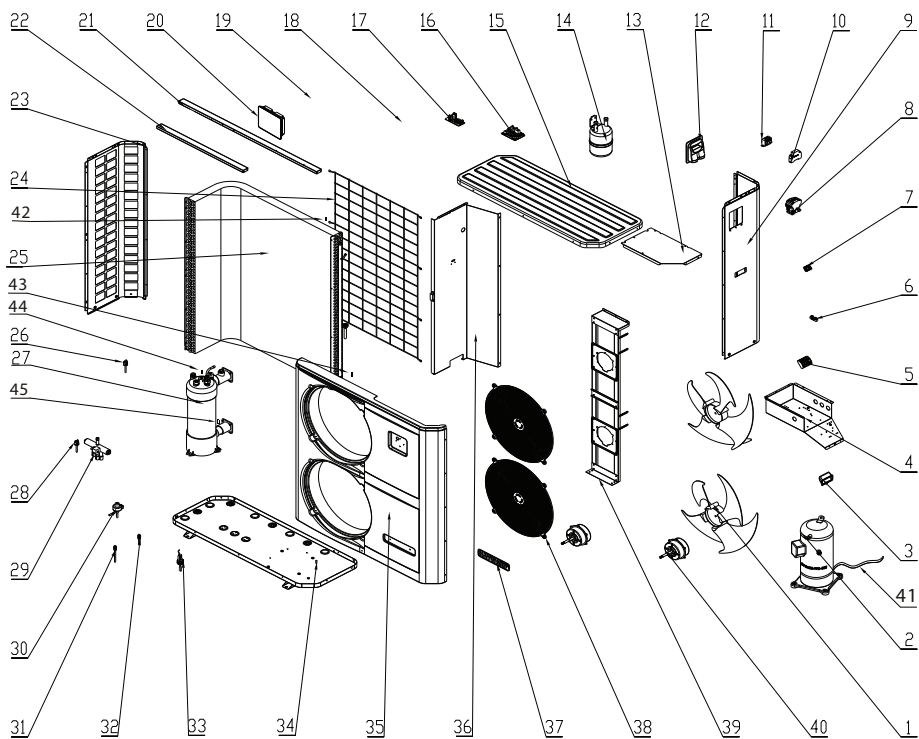

## 6. ANNEXES (suite)

### ENP7TASC

Rep	Réf.	Désignation	Rep	Réf.	Désignation
1	HWX20000270004	Hélice ventilateur	26	HWX20013605	Pressostat haute pression
2	HWX20000110138	Compresseur	27	HWX32019120007	Condenseur Titane PVC
3	HWX32008220037	Poignée	28	HWX20003603	Pressostat basse pression
4	HWX32019210024	Coffret électrique	29	HWX20011491	Vanne 4 voies
5	HWX20003902	Bornier 5 connexions Tri	30	HWX20000140398	Détendeur électronique
6	HWX20003909	Bornier 2 connexions	31		
7	HWX20003933	Bornier 3 connexions	32		
8	HWX20003653	Contacteur Compresseur TRI	33	HWX200036005	Détecteur de débit d'eau
9	HWX32019210027	Panneau droit	34	HWX32019210061	Fond
10	HWX200036023	Contrôleur de phase	35	HWX32019210049	Panneau avant
11	HWX200037003	Transformateur 230V <sub>~</sub> - 12V <sub>~</sub>	36	HWX32019210026	Panneau de séparation
12	HWX32009220032	Trappe d'accès électrique	37	HWX20000230596	Logo Hayward
13	HWX32019210025	Panneau de protection électrique	38	HWX20000220169	Grille de protection ventilateur
14	HWX20001440	Réservoir de liquide	39	HWX32019210022	Support Moteur
15	HWX32019220001	Panneau supérieur	40	HWX20000330132	Moteur DC
16	HWX95053114511E	Carte électronique	41	HWX20003214	Résistance de Carter
17	HWX950531024102	Module DC Inverter	42	HWX20003242	Sonde température d'air
*18*	HWX20003223	Sonde compresseur 50k $\Omega$	43		Sonde température évaporateur
19	/	/	44		Sonde d'entrée d'eau
20	HWX95005010018	Régulateur LED	45		Sonde de sortie d'eau
21	HWX32019210030	Raidisseur Large	*46*	HWX20002625	Silent bloc
22	HWX32019210029	Raidisseur Petit	*47*	HWX200026009	Joint torique ID 48-Ep 5mm
23	HWX32019210028	Panneau gauche	*48*	HWX200026061	Joint torique ID 43-Ep 3.4mm
24	HWX32019210031	Protection Évaporateur	*49*	HWX20000240112	Couverture d'hivernage
25	HWX32019120002	Évaporateur	*50*	HWX20001345	Bouchon de vidange

Nota : Les repères \*xx\* ne sont pas référencés sur la vue éclatée correspondante.

## 6. ANNEXES (suite)

---

### 6.4 Guide de dépannage



*Certaines opérations doivent être réalisées par un technicien habilité.*

En cas de défaut, les indications suivantes s'affichent à l'écran :

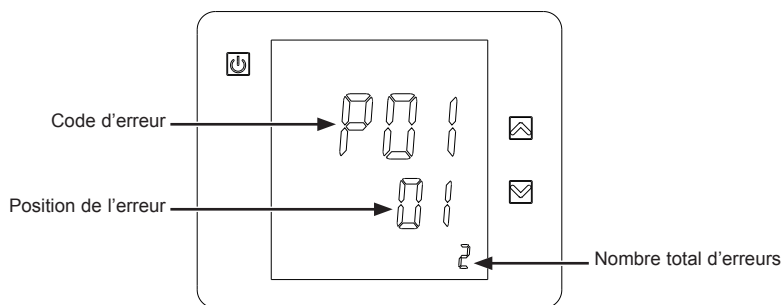

En cas d'erreur multiple, pressez sur  ou  pour faire défiler les codes d'erreur. Reportez vous au tableau ci-après.

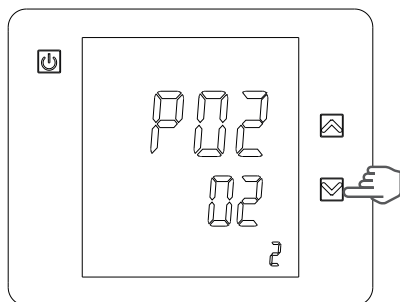



## 6. ANNEXES (suite)

Dysfonctionnement	Codes d'erreur	Description	Solution
Défaut sonde entrée d'eau	P01	Le capteur est ouvert ou présente un court-circuit.	Vérifier ou remplacer le capteur.
Défaut sonde sortie d'eau	P02	Le capteur est ouvert ou présente un court-circuit.	Vérifier ou remplacer le capteur.
Défaut sonde de dégivrage	P05	Le capteur est ouvert ou présente un court-circuit.	Vérifier ou remplacer le capteur.
Défaut sonde température extérieure	P04	Le capteur est ouvert ou présente un court-circuit.	Vérifier ou remplacer le capteur.
Défaut sonde compresseur	P07	Le capteur est ouvert ou présente un court-circuit.	Vérifier ou remplacer le capteur.
Différence de température trop grande entre l'eau en sortie et l'eau en entrée	E06	Débit d'eau en volume insuffisant, différence de pression d'eau trop faible / trop élevée.	Vérifier le débit d'eau, ou l'obstruction du système.
Protection Antigel Mode froid	E07	Quantité d'eau sortante trop faible.	Vérifier le débit d'eau, ou le capteur de température d'eau sortante.
Protection antigel de niveau 1	E19	Température ambiante, ou de l'eau entrante trop faible.	
Protection antigel de niveau 2	E29	Température ambiante, ou de l'eau entrante encore plus faible.	
Protection haute pression	E01	Pression du circuit frigorifique trop élevée, ou débit d'eau trop faible, ou évaporateur obstrué, ou débit d'air trop faible.	Vérifier le pressostat haute pression et la pression du circuit frigorifique. Vérifier le débit d'eau ou d'air. Vérifier le bon fonctionnement du contrôleur de débit. Vérifier l'ouverture des vannes entrée/sortie d'eau. Vérifier le réglage du by-pass.
Protection basse pression	E02	Pression du circuit frigorifique trop faible, ou débit d'air trop faible ou évaporateur obstrué.	Vérifiez le pressostat basse pression et la pression du circuit frigorifique pour évaluer s'il existe une fuite. Nettoyer la surface de l'évaporateur. Vérifier la vitesse de rotation du ventilateur. Vérifier la libre circulation de l'air à travers l'évaporateur.
Défaut détecteur de débit	E03	Débit d'eau insuffisant ou détecteur en court circuit ou défectueux	Vérifiez le débit d'eau, vérifiez la pompe de filtration et le détecteur de débit pour voir s'ils présentent d'éventuels dysfonctionnements.
Problème de communication	E08	Dysfonctionnement du contrôleur LED ou de la connexion PCB.	Vérifier la connexion des câbles NET et NET 1.
Le compresseur ne démarre pas	E08	Manque une phase ou ordre des phases incorrecte	Vérifier la présence des (3) phases Modifier l'ordre des phases au niveau du bornier de raccordement électrique de la pompe à chaleur.

## **6. ANNEXES (suite)**

---

### **6.5 Garantie**

#### **CONDITIONS DE GARANTIE**

Tous les produits HAYWARD sont garantis contre tous vices de fabrication ou de matière pendant une période de deux années à compter de la date d'achat. Toute demande de garantie devra être accompagnée d'une preuve d'achat justifiant sa date. Nous vous incitons donc à conserver votre facture.

La garantie HAYWARD est limitée à la réparation ou au remplacement, au choix d'HAYWARD, des produits défectueux pour autant qu'ils aient subi un emploi normal, en accord avec les prescriptions mentionnées dans leur manuel d'utilisation, que le produit n'ait été modifié d'aucune sorte et utilisé uniquement avec des composants et des pièces HAYWARD. Les dommages dus au gel et aux attaques d'agents chimiques ne sont pas garantis.

Tous les autres frais (transport, main d'œuvre...) sont exclus de la garantie.

HAYWARD ne pourra être tenu pour responsable d'aucun dommage direct ou indirect provenant de l'installation, du raccordement ou du fonctionnement incorrect d'un produit.

Pour faire jouer une garantie et demander la réparation ou le remplacement d'un article, adressez vous à votre revendeur. Aucun retour de matériel à notre usine ne sera accepté sans notre accord écrit préalable.

Les pièces d'usure ne sont pas couvertes par la garantie.

ISENPASC Rev C

# ***ENERGYLINE PRO***

**SWIMMING POOL HEAT PUMP UNIT**



**Installation & Instruction Manual**

# CONTENTS

---

<b>1. Preface</b>	<b>1</b>
<hr/>	
<b>2. Specifications</b>	<b>2</b>
2.1 Technical data for the swimming pool heat pump unit	2
2.2 Operating range	3
2.3 Dimensions	4
<hr/>	
<b>3. Installation and connection</b>	<b>5</b>
3.1 Functional diagram	5
3.2 Heat pump unit	6
3.3 Hydraulic connection	6
3.4 Electrical connection	7
3.5 Initial start-up	8
3.6 Water flow setting	10
<hr/>	
<b>4. User interface</b>	<b>11</b>
4.1 Overview	11
4.2 Clock function/settings	13
4.3 Tuner function/settings	13
4.4 Operation mode selection	14
4.5 Setting and visualisation of the set point	15
4.6 Locking and unlocking the touch screen	15
4.7 Silent function settings	16
<hr/>	
<b>5. Maintenance and Winterising</b>	<b>19</b>
5.1 Maintenance	19
5.2 Winterising	19
<hr/>	
<b>6. Appendix</b>	<b>20</b>
6.1 Electrical Diagrams	20
6.2 Heating priority wiring	22
6.3 Exploded view and spare parts	24
6.4 Troubleshooting guide	30
6.5 Warranty	32

Please read attentively and save for future consultation.

This document must be given to the pool owner and should be kept in a safe place.

# 1. PREFACE

---

We thank you for purchasing this Hayward swimming pool heat pump unit. This product was designed according to strict manufacturing standards to satisfy the required quality levels. This manual includes all of the necessary information concerning installation, debugging and maintenance. Please attentively read this manual before opening the unit or before carrying out any maintenance operations on it. The manufacturer of this product will not, under any circumstances, be held responsible in the case of injury to the user or damage to the unit resulting from improper installation, debugging or unnecessary maintenance. It is essential to follow all of the instructions specified in the manual at all times. The unit must be installed by a qualified professional.

- Repairs must be made by a qualified professional.
- All electrical connections must be made by a qualified electrician according to standards in the country of installation see § 3.4.
- Maintenance and the different operations must be carried out at the recommended times and frequencies as specified in this manual.
- Only use genuine spare parts.
- Failure to comply with these recommendations will invalidate the warranty.
- This swimming pool heat pump unit heats swimming pool water and maintains a constant temperature; it should not be used for any other purpose.

After having read this manual, keep it for future usage.

Warnings concerning children/people with reduced physical capacity:

This appliance is not intended to be used by persons (especially children) with reduced physical, sensory or mental capabilities or by persons who lack experience or knowledge, unless they are under supervision or have received instructions concerning the use of the appliance by a person responsible for their safety.

This product contains greenhouse effect fluorinated gases covered by the Kyoto protocol.

Type of refrigerant: R410A

GAP Value<sup>(1)</sup>: 1975

Periodic inspections for refrigerant leakage can be required as a function of European or local legislation. Please contact your local distributor for additional information.

---

(1) Potential for global warming

## 2. SPECIFICATIONS

---

### 2.1 Technical data for the swimming pool heat pump unit

Models	ENERGYLINE PRO	ENP6MASC	ENP6TASC	ENP7TASC
Heating capacity*	kW	17,8	18,2	23,4
Absorbed electrical power *	kW	3,69	3,7	5,15
Running current*	A	16,2	7,69 / 6,89 / 6,33	9,71 / 8,01 / 7,70
Power supply	V Ph/Hz	230V∨ 50Hz	400V 3N∨ 50Hz	400V 3N∨ 50Hz
aM type fuse calibre	A	20	12	16
Curve D circuit breaker	A	20	12	16
Compressor quantity		1	1	1
Type of compressor		Scroll	Scroll	Scroll
Fan quantity		2	2	2
Fan power	W	50 — 225	50 — 225	50 — 225
Fan rotation speed	RPM	600 — 950	830 — 960	800 — 1050
Ventilation		Horizontal	Horizontal	Horizontal
Sound pressure level (at 1 metre)	dB(A)	45	45	47
Hydraulic connection	mm	50	50	50
Nominal water flow*	m <sup>3</sup> /h	6,6	6,6	8
Water pressure drop (max)	kPa	7	7	18
Unit net dimensions (L/I/h)	mm	1138 / 470 / 1264	1138 / 470 / 1264	1138 / 470 / 1264
Net weight per unit	kg	127	123	140

\* Value at +/- 5% under the following conditions: Exterior temperature = 15°C (59°F) / HR = 71% /  
Water inflow temperature = 26°C (78.8°F).



In accordance with the NF -414 standard (annual use)

## 2. SPECIFICATIONS (continued)

---

### 2.2 Operating range

Use the swimming pool heat pump unit within the following ranges of temperature and humidity to ensure safe and efficient operation.

	Heating mode 	Cooling mode 
Outside temperature	-12°C ~ +35°C	+7°C ~ +43°C
Water temperature	+12°C ~ +40°C	+8°C ~ +40°C
Relative humidity	< 80%	< 80%
Setting range from the set point	+15°C ~ +32°C	+8°C ~ +32°C



***If the temperature or humidity does not correspond to these conditions, the security measures could be activated and the swimming pool heat pump unit may no longer work.***



***The maximum heating temperature is set at 32°C to prevent damage to the liners. Hayward cannot be held responsible if used at a temperature above +32°C.***

## 2. SPECIFICATIONS (continued)

### 2.3 Dimensions

Models: ENP6MASC / ENP6TASC / ENP7TASC

Unit: mm

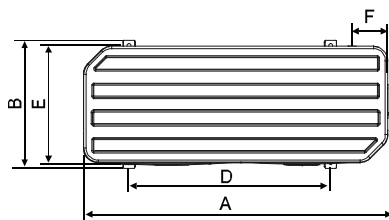
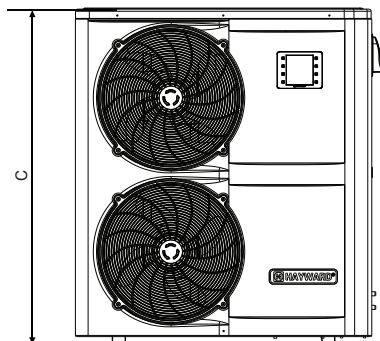
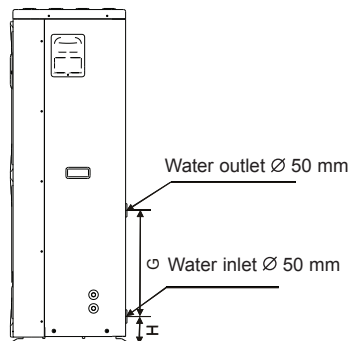

TYPE SIZE (mm)	ENP6MASC	ENP6TASC ENP7TASC
A	1138	1138
B	470	470
C	1264	1264
D	790	790
E	447	447
F	114	114
G	500	400
H	104	104



### 3. INSTALLATION AND CONNECTION

#### 3.1 Functional Diagram

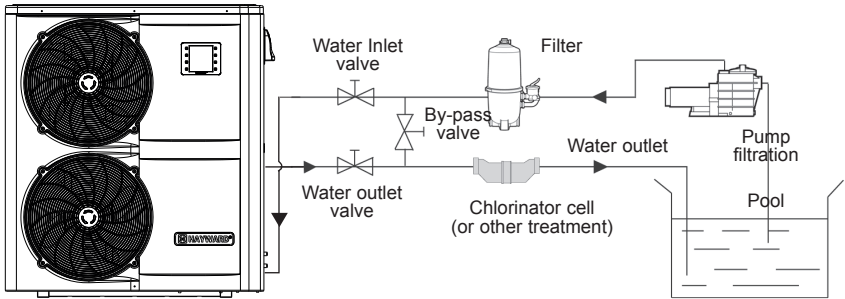

Note : The swimming pool heat pump unit is sold without any treatment or filtration equipment. The components presented in the diagram are spare parts to be supplied by the installer.

#### 3.2 Heat pump



**Place the heat pump outdoors and away from any enclosed technical space.**

**Placed under a shelter, the minimum required distances mentioned below must be respected in order to avoid any risk of air recirculation and a deficiency in the unit's overall performance.**

Unit: mm

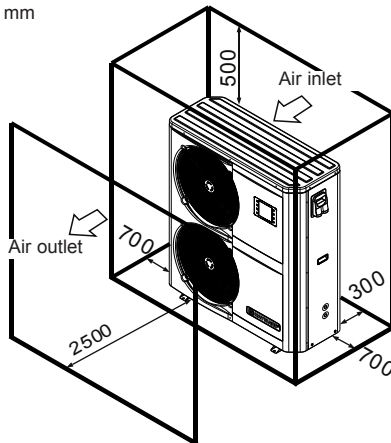

### 3. INSTALLATION AND CONNECTION (continued)

---



*It is advised to install the unit on a dissociated cement block or a mounting bracket designed for this use and to set up the unit on the supplied rubber bushing (fastenings and washers not supplied).*

*The maximum installation distance between the unit and the swimming pool is 15 metres.*

*The total length of the piping to and from the unit is 30 metres.*

*Insulate both the above ground and buried hydraulic piping.*

#### 3.3 Hydraulic connection

The unit is supplied with two 50 mm Ø union connections. Connect the water inlet to the heat pump coming from the filtration group then connect the water outlet to the heat pump at the water conduit going to the pool (see diagram below).

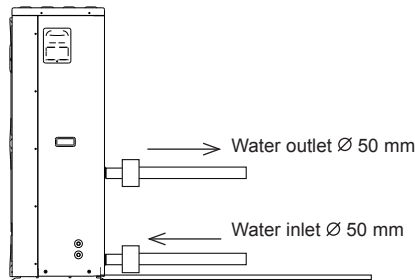

Install a by-pass valve between the heat pump entrance and exit.



*If an automatic distributor or an electrolyser is used, it should be installed imperatively after the heat pump with the goal of protecting the titanium condenser against an elevated concentration of chemicals.*



*Be sure to install the by-pass valve and the supplied union connections at the water inlet and outlet level in order to simplify purging during the winter period and to facilitate access when disassembling for maintenance.*

### 3. INSTALLATION AND CONNECTION (continued)

#### 3.4 Electrical connection



**Electrical installation and wiring for this equipment must be in conformity with local installation standards.**

F	NF C15-100	GB	BS7671:1992
D	DIN VDE 0100-702	EW	EVHS-HD 384-7-702
A	ÖVE 8001-4-702	H	MSZ 2364-702/1994/MSZ 10-553 1/1990
E	UNE 20460-7-702 1993, RECBT ITC-BT-31 2002	M	MSA HD 384-7-702.S2
IRL	Wiring Rules + IS HD 384-7-702	PL	PN-IEC 60364-7-702:1999
I	CEI 64-8/7	CZ	CSN 33 2000 7-702
LUX	384-7.702 S2	SK	STN 33 2000-7-702
NL	NEN 1010-7-702	SLO	SIST HD 384-7-702.S2
P	RSIUEE	TR	TS IEC 60364-7-702



**Verify that the available electrical power supply and the network frequency correspond to the required operating current taking into account the appliance's specific location, and the current required to supply any other appliance connected to the same circuit.**

**ENP6MASC 230 V $\sqrt{\phantom{x}}$  +/- 10 % 50 Hz 1 Phase**

**ENP6TASC 400 V $\sqrt{\phantom{x}}$  +/- 10 % 50 Hz 3 Phases**

**ENP7TASC 400 V $\sqrt{\phantom{x}}$  +/- 10 % 50 Hz 3 Phases**



**Check that the phases balance does not exceed 2%**

**See the corresponding wiring diagram in the appendix.**

**The connection box is located on the right side of the unit. Three connections are designed for the power supply and two are for controlling the filter pump (Enslavement).**

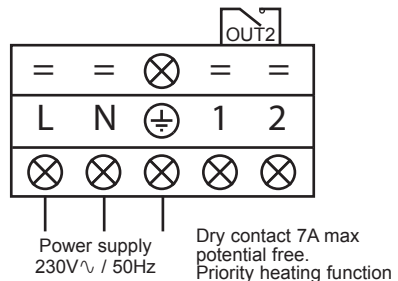
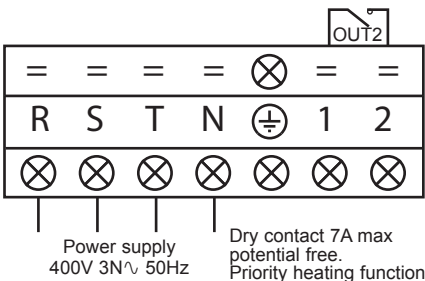

### 3. INSTALLATION AND CONNECTION (continued)

---



*The electrical power supply must have, when appropriate, a fuse protection device like a feed motor (aM) or D curve circuit breaker as well as a differential circuit breaker 30mA (see following table).*

Models		ENP6MASC	ENP6TASC	ENP7TASC
Power supply	V/Ph/ Hz	230V~ 50Hz	400V 3N~ 50Hz	400V 3N~ 50Hz
aM type fuse calibre	A	20 aM	12 aM	16 aM
Curve D circuit breaker	A	20 D	12 D	16 D
Cable section	mm <sup>2</sup>	3G6 3 x 6	5G2,5 5 x 2,5	5G2,5 5 x 2,5



*Use an RO 2V/R 2V or equivalent power cord.*



*The cables sections are given for a maximum length of 25 m. They must however be checked and adjusted according to the installation conditions.*



*Always shut down the main power supply before opening the electrical control box.*

#### 3.5 Initial start-up

Start-up procedure - After installation is complete, follow these steps:

- 1) Rotate the fans by hand to verify that they can turn freely by hand, and that the turbine is correctly affixed to the motor shaft.
- 2) Ensure that the unit is connected correctly to the main power supply (see the wiring diagram in the appendix).
- 3) Activate the filtration pump.
- 4) Verify that all water valves are open and that the water flows toward the unit before switching on the heating or cooling mode.
- 5) Verify that the drainage hose is correctly affixed and that it causes no obstructions.
- 6) Activate the unit power supply, then press the On/Off button  on the control panel.
- 7) Ensure that no ALARM code is displayed when the unit is ON (see troubleshooting guide).

### 3. INSTALLATION AND CONNECTION (continued)

---

- 8) Set the water flow using the by-pass valve (see § 3.6 and 2.1), as provided for by each model, to obtain an Entry/Exit temperature of 2°C.
- 9) After running for several minutes, verify that the air exiting the unit is cool (between 5 and 10°).
- 10) With the unit operating, turn off the filter pump. The unit should automatically turn off and display error code E03.
- 11) Allow the unit and the pool pump to run 24 hours per day until the desired water temperature has been reached. When the set water inlet temperature is reached, the unit will turn off. It will automatically restart (as long as the pool pump is running) if the pool temperature is at least 0.5°C below the set temperature.

**Water flow switch** - The unit is equipped with a flow switch that turns on the heat pump when the pool filtration pump is running, and deactivates it when the filtration pump is out of order. If the water is low, the E03 alarm code will appear on the regulator (See § 6.4).

**Time delay** - The unit is equipped with a time delay of 3 minutes in order to protect the control circuit components, to eliminate restart cycling and contactor chatter. Thanks to this time delay, the unit automatically restarts approximately 3 minutes after each control circuit interruption. Even a brief power interruption will activate the restart time delay.

**Phase switch** - The Triphasic units include a phase switch to ensure that the compressor is rotating in the correct direction. If the unit does not start, check the condition of the phase switch located in the electrical box.

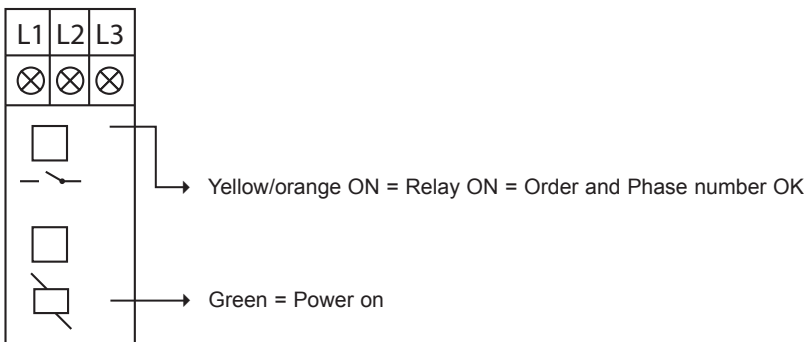

### 3. INSTALLATION AND CONNECTION (continued)

---

#### 3.6 Water flow setting

With the water entry and exit valves being open, adjust the by-pass valve in order to obtain a difference of 2°C between the inflow and outflow temperature (see principle diagram § 3.1). You can verify the switch by seeing the entry/exit temperatures directly on the control panel.

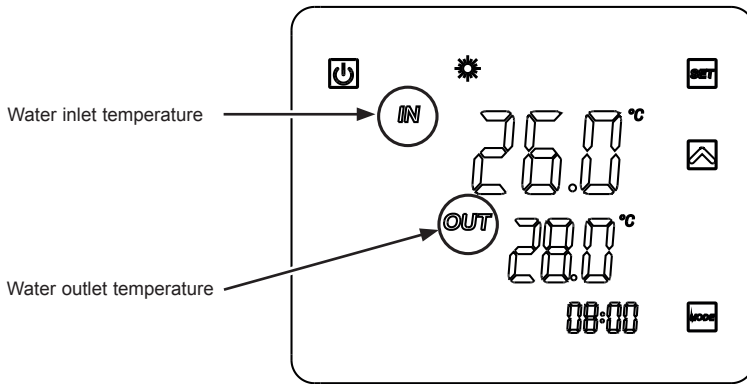

Note: Opening the by-pass valve creates a weaker flow, which leads to an increase in  $\Delta T$ .

Closing the by-pass valve creates a stronger flow, which leads to a decrease in  $\Delta T$ .

# 4. USER INTERFACE

## 4.1 General presentation

The heat pump is equipped with a digital control panel with a touch screen, electronically connected and pre-set at the factory in heating mode.

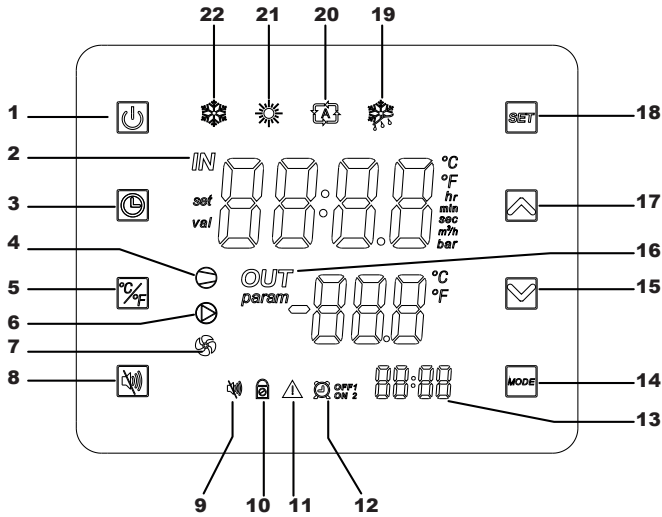

### Legend

1		On/Off
2	<i>IN</i>	Water inlet
3		Clock and timer settings
4		Compressor ON
5		Conversion °C/°F
6		Dry contact OUT2
7		Fan ON
8		Silent mode
9		Silent mode indicator
10		Locked screen
11		Alarm

12		Timers 1 and 2
13		Timers' time
14		Mode selection
15		Défilement bas / Diminuer
16	<i>OUT</i>	Water outlet
17		Scroll down / Decrease
18		Save / settings
19		Defrost mode
20		Automatic mode
21		Heating mode
22		Cooling mode

## 4. USER INTERFACE (continued)

---

### OFF Mode

When the heating pump is in sleep mode (OFF Mode) “OFF” is displayed on the command screen.

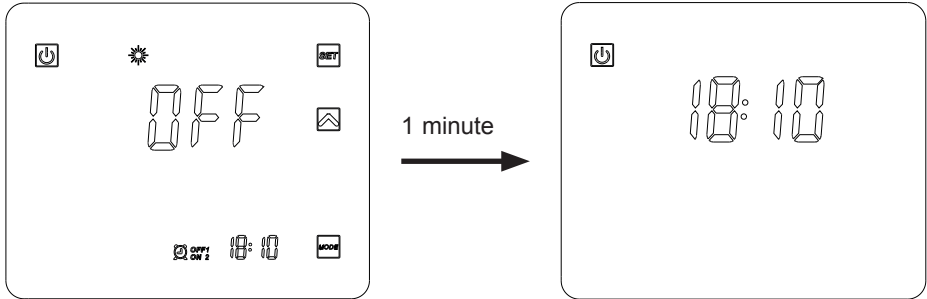

### ON Mode

When the heating pump is running or regulating (ON Mode), the inlet and outlet water temperatures are displayed on the command screen.

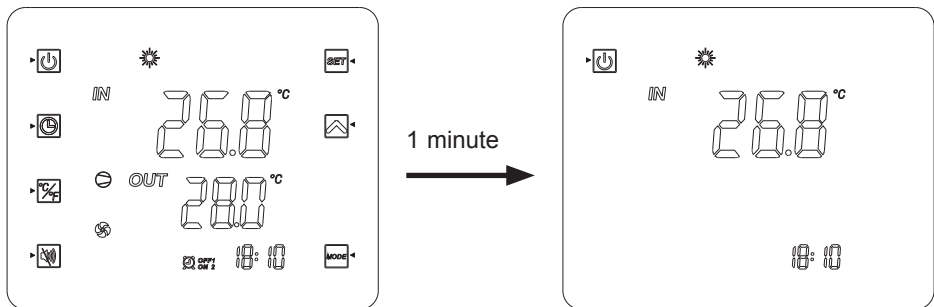













## 4. USER INTERFACE (continued)

At the end of a setting, press  to validate.

The settings will be automatically saved if no button is pressed during 20s.

### 4.2 Clock settings

If the display is in standby mode, press briefly on .









- 1) Press  to bring up the symbol .
- 2) Press  to make the time display flash. Set the hour using the buttons  .
- 3) Press  then set the minutes with the buttons  .
- 4) Press  to validate.

### 4.3 Timer function settings











Setting this function is necessary if you would like to run the heat pump for a shorter period than what is defined by the filtration clock. Therefore, you can program a deferred start and an anticipated stop or simply stop a certain timeframe from running (at night, for example).

It is possible to set 2 Start Timers (ON1 et ON2) and 2 Stop Timers (OFF1 et OFF2).

#### Timer 1 setting – Start

- 1) Press  for 2s, Timer ON1  <sup>ON 1</sup> flashes (\*).
- 2) Press  to set the hours with the buttons  .
- 3) Press  to set the minutes with the buttons  .
- 4) Press  to validate.

#### Timer 1 setting – Stop



- 1) Press  for 2s, Timer ON1  <sup>ON 1</sup> flashes (\*).  
Press  once, Timer OFF1  <sup>OFF1</sup> flashes.
- 2) Press  to set the hours with the buttons  .
- 3) Press  to set the minutes with the buttons  .
- 4) Press  to validate.

(\* To access Timer ON2  <sup>ON 2</sup> directly, press  for 2s, then press  twice.



## 4. USER INTERFACE (continued)

### Timer 2 settings

















After the Timer 1 settings, you will access directly the settings for Timer 2:

 and .

Proceed in the same manner as for Timer 1.

**Nota:** To access directly Timer ON2 , press  for 2s, then press twice on .

### Timers suppression (Start and Stop)

- 1) Press  for 2s, Timer ON1  flashes.(\*)
  - 2) Press  to make the time display flash.
  - 3) Press  to suppress the Timer .
  - 4) Press  to validate.
  - 5) Press  for 2s, the Timer  flashes.  
Press once , the Timer  flashes.(\*)
  - 6) Press  to make the time display flash.
  - 7) Press  to suppress the Timer .
- (\*) To access Timers 2  or , follow steps 1) or 4) then press twice . Proceed in the same manner as above.

### 4.4 Operation mode selection: cooling, heating or automatic In Mode “OFF” or “ON”

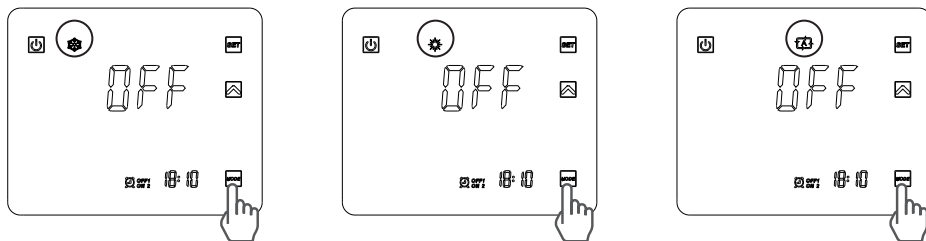

Press the button  to change mode: cooling, heating or automatic.



*If the heat pump is set in heating only or cooling only, changing mode is not possible.*



## 4. USER INTERFACE (continued)

### 4.5 Setting and visualisation of the set point (desired water temperature)

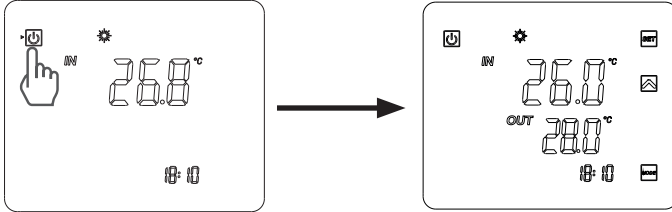
If the button  is not visible on the screen, press  briefly.  
(While operating or stopped, simply press the button  to view the set point)



#### In Mode “OFF” or Mode “ON”



Press the button  to display the set point, then press  or  to set the set point you wish.

The setting is made with a precision of 0.5 °C.



*It is recommended to never exceed 30°C to avoid alteration of the liners.*

### 4.6 Locking and unlocking the touch screen

Press the button  for 5 s until it beeps and this symbol appears .

To unlock, press  for 5 s until it beeps and this symbol disappears .

## 4. USER INTERFACE (continued)

### 4.7 SILENT function settings (🔇)

This function allows the heat pump to be used at a fan rotation speed reduced to 600 rpm for the ENP6MASC, 830 rpm for the ENP6TASC and 800 rpm for the ENP7TASC for a maximum of 8 hours, in order to limit noise problems during the night or day depending on the location of the heat pump in relation to neighbours and/or the pool.



This function can be Activated/Deactivated manually or using a Timer.

#### Manual Activation

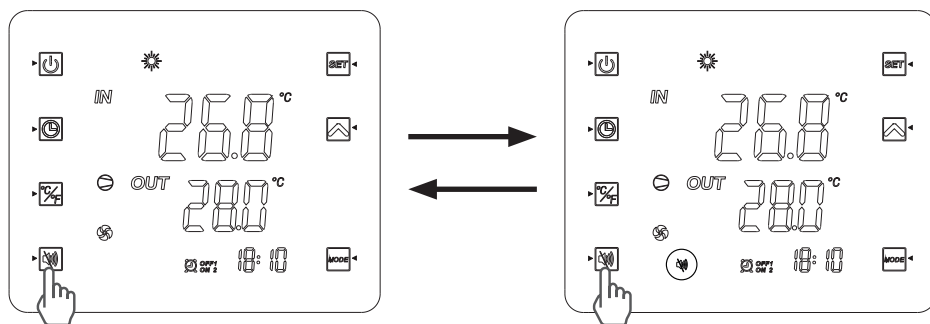
- 1) Press on .
- 2) The display below appears on the screen. The SILENT mode is activated for the next 8 hours.
- 3) The fans gradually reduce their rotation speed for a maximum duration of 8 h.
- 4) After operating for 8 h the function will automatically be deactivated and the fans will return to a rotation speed that varies according to the temperature of the outside air.



#### Manual Deactivation

- 1) Press on .
- 2) The symbol  disappears from the screen: Silent mode is deactivated.
- 3) The fans adjust their rotation speed according to the outdoor air temperature.

## 4. USER INTERFACE (continued)

---





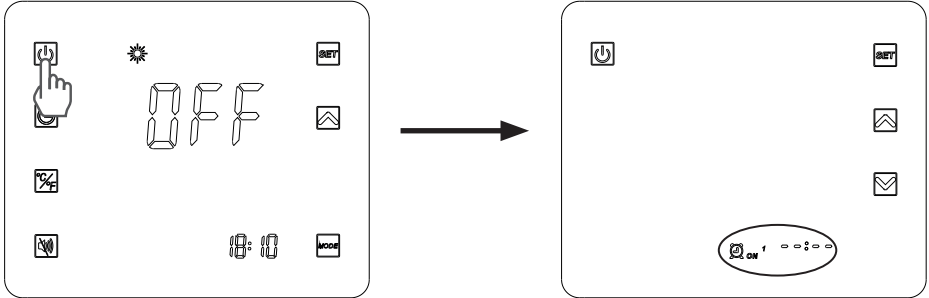

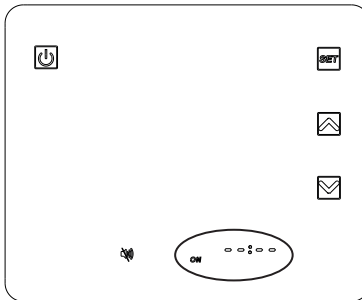

### Programming the SILENT mode

1) Press  for 2s : the Timer ON1  ON 1 flashes.



2) Press 4 times on  until the screen below is displayed.





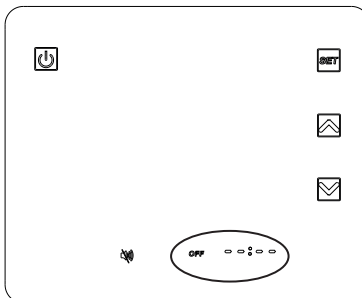





- 3) Press  to make the hour display flash. Use the arrows   to set the start time.
- 4) Press  to make the minutes display flash. Use the arrows   to set the start time. Press  to validate.
- 5) Press  to set the end time: the **OFF** sign will flash.



## 4. USER INTERFACE (continued)

---

- 6) Press  to make the hour display flash. Use the arrows   to set the end time.
- 7) Press  to make the minutes display flash. Use the arrows   to set the end time. Press  to validate.
- 8) Press  to return to the previous screen.  
The **ON-OFF** signs are displayed as below.

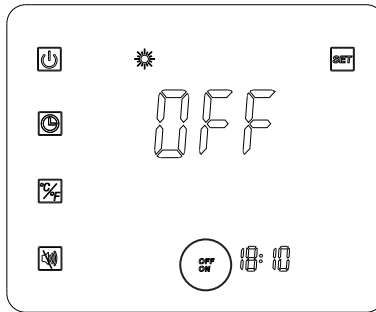

**Nota :** The minutes are set in 10-minute increments.

Once the SILENT mode has been set, it will be active by default 7 days a week.

## 5. MAINTENANCE AND WINTERISING

---

### 5.1 Maintenance

These maintenance operations must be carried out once per year in order to guarantee the longevity and the good working condition of the heat pump.

- Clean the coil with the help of a soft brush or jet of air or water (**Warning, never use a high pressure cleaner**).
- Verify that the drains flow well.
- Verify the tightening of the hydraulic and electrical connections
- Verify the hydraulic sealing of the condenser.



***Before any maintenance operation, the heating pump must be disconnected from any electrical current source. The maintenance operations must only be carried out by personnel that is qualified and authorised to handle liquid refrigerants.***

### 5.2 Winterising

- Put the heat pump in “OFF” mode.
- Cut the power supply to the heat pump.
- Empty the condenser with the help of the drain to avoid any risk of deterioration. (high risk of freezing).
- Close the by-pass valve and unscrew the entry/exit connection unions.
- Eliminate the maximum amount of residual stagnant water from the condenser with the help of an air gun.
- Close the water entry and exit areas of the heating pump to avoid introducing foreign bodies.
- Cover the heating pump with a dedicated winterising case.



***Any damage caused by poor winterising maintenance will lead to cancellation of the warranty.***

# 6. APPENDIX

## 6.1 Electrical diagrams

### ENP6MASC

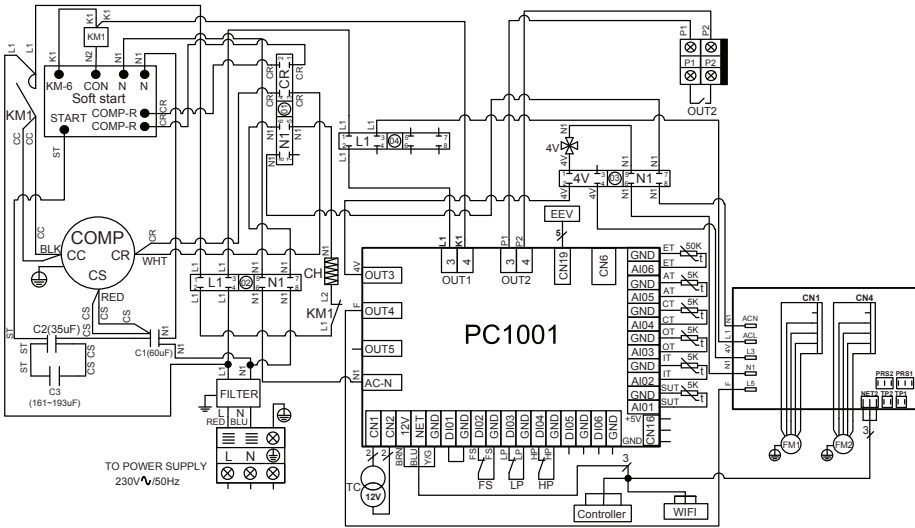

**REMARKS:**

- |   |  |
|---|--|
| <ol style="list-style-type: none"> <li>1. AT: AIR TEMPERATURE SENSOR</li> <li>2. COMP: COMPRESSOR</li> <li>3. CT: EVAPORATOR TEMPERATURE SENSOR</li> <li>4. EEV: ELECTRONIC EXPANSION VALVE</li> <li>5. FM1-2: FAN MOTOR</li> <li>6. FS: WATER PRESENCE DETECTOR</li> <li>7. HP: HIGH PRESSURE SWITCH</li> <li>8. IT: WATER INLET TEMPERATURE SENSOR</li> <li>9. LP: LOW PRESSURE SWITCH</li> </ol> | <ol style="list-style-type: none"> <li>10. OT: OUTLET WATER TEMPERATURE SENSOR</li> <li>11. SUT: ASPIRATION TEMPERATURE SENSOR</li> <li>12. TC: TRANSFORMER 230V<math>\surd</math> / 12V<math>\surd</math></li> <li>13. 4V: 4 WAYS VALVE</li> <li>14. KM1 : POWER CONTACTOR</li> <li>15. SOFT START : ELECTRONIC STARTER</li> <li>16. CH : SUMP HEATER</li> <li>17. OUT2 : DRY CONTACT 7 A MAX</li> <li>18. ET : DISCHARGE TEMPERATURE SENSOR</li> </ol> |
|---|--|



# 6. APPENDIX (continued)

## ENP6TASC - ENP7TASC

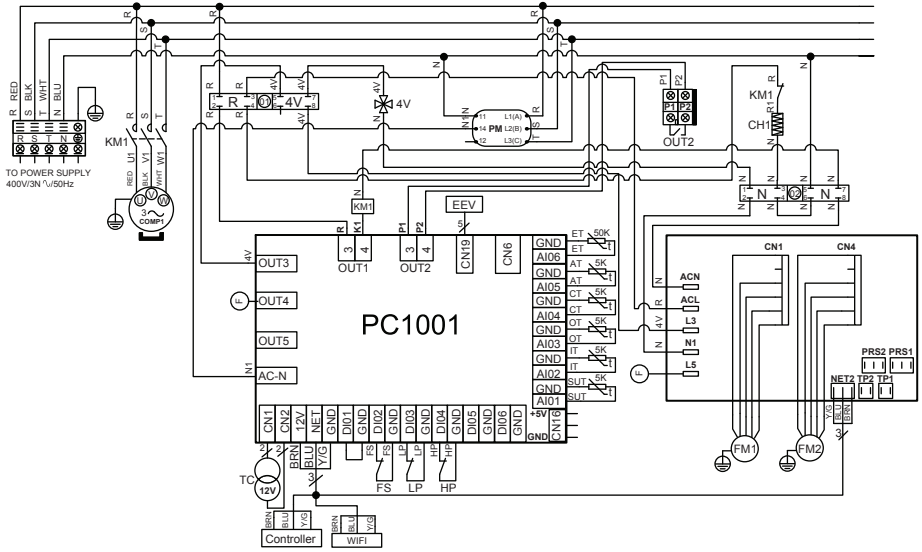

### REMARKS:

1. AT: AIR TEMPERATURE SENSOR
2. COMP: COMPRESSOR
3. CT: EVAPORATOR TEMPERATURE SENSOR
4. EEV: ELECTRONIC EXPANSION VALVE
5. FM1-2: FAN MOTOR
6. FS: WATER PRESENCE DETECTOR
7. HP: HIGH PRESSURE SWITCH
8. IT: WATER INLET TEMPERATURE SENSOR
9. LP: LOW PRESSURE SWITCH
10. OT: OUTLET WATER TEMPERATURE SENSOR
11. SUT: ASPIRATION TEMPERATURE SENSOR
12. TC: TRANSFORMER 230V~/ 12V~
13. 4V: 4 WAYS VALVE
14. KM1 : POWER CONTACTOR
- 15 : PM : PHASE SWITCH
- 16 : CH1 : SUMP HEATER
17. OUT2 : DRY CONTACT 7 A MAX
18. ET : DISCHARGE TEMPERATURE SENSOR

## 6. APPENDIX (continued)

### 6.2 Heating priority wiring for monophasic pump

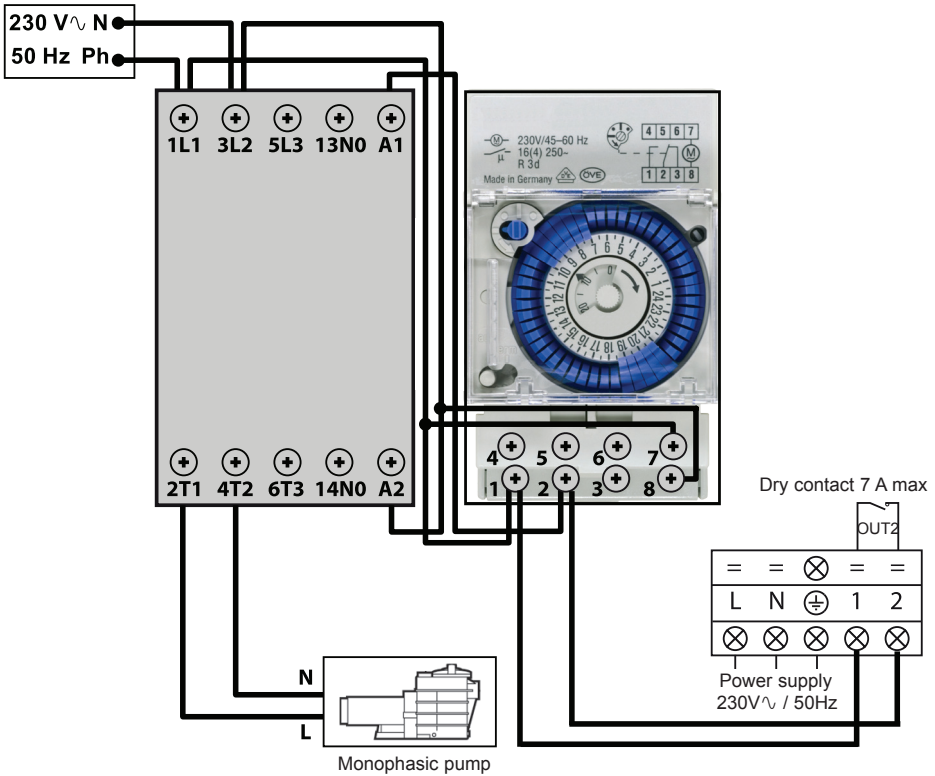

Terminals 1 and 2 deliver a potential-free dry contact, 230 V  $\sim$  / 50 Hz, no polarity.

Wire terminals 1 and 2 as indicated in the diagram above, to activate the operation of the filtration pump in 2-minute cycles each hour if the temperature of the pool is lower than the set point.

 Never connect the power supply of the filtration pump directly to terminals 1 and 2.



# 6. APPENDIX (continued)

## 6.2 Heating priority wiring for three phases pump

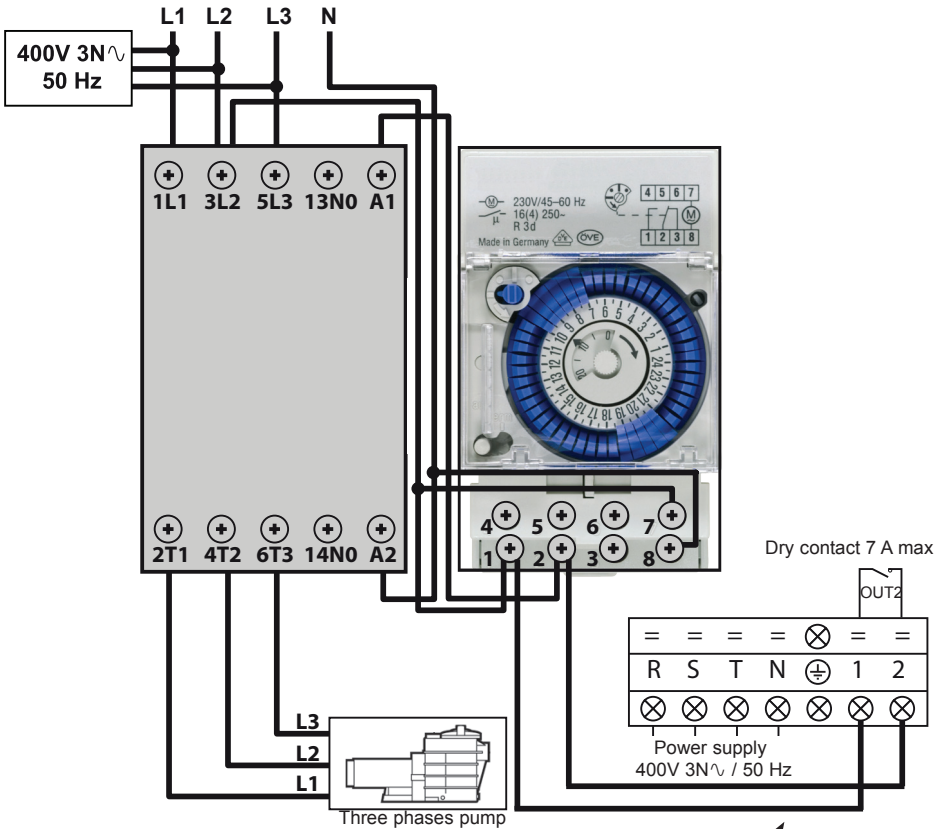

Terminals 1 and 2 deliver a potential-free dry contact, 230 V $\sim$  / 50 Hz, no polarity.

Wire terminals 1 and 2 as indicated in the diagram above, to activate the operation of the filtration pump in 2-minute cycles each hour if the temperature of the pool is lower than the set point.

**⚠** Never connect the power supply of the filtration pump directly to terminals 1 and 2.



## 6. APPENDIX (continued)

### 6.3 Exploded view and spare parts

#### ENP6MASC

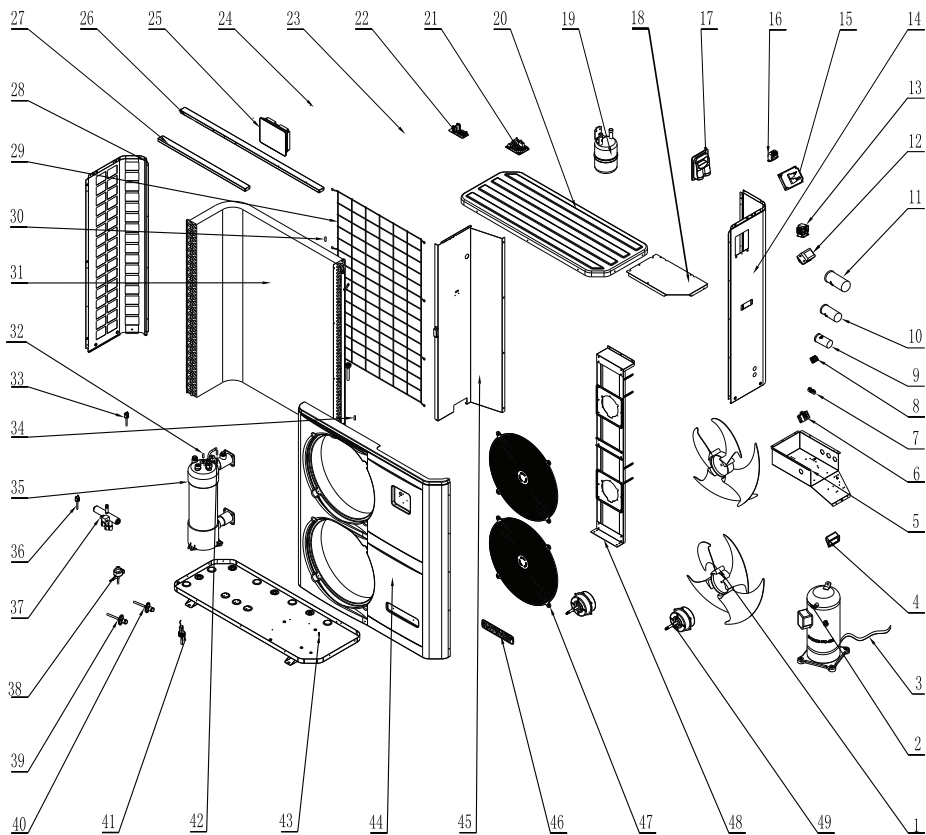

## 6. APPENDIX (continued)

### ENP6MASC

Rep	Réf.	Désignation	Rep	Réf.	Désignation
1	HWX20000270004	Fan blade	28	HWX32019210028	Left Panel
2	HWX200011112	Compressor	29	HWX32019210031	Coil protection
3	HWX20003214	Crankcase heater	30	HWX20003242	Ambiente temp sensor
4	HWX32008220037	Handle	31	HWX32010120008	Fin coil
5	HWX32019210040	Electrical box	32	HWX20003242	Water inlet temp Sensor
6	HWX20003920	Terminal block 3 connections	33	HWX20013605	High pressure switch
7	HWX20003909	Terminal block 2 connections	34	HWX20003242	Coi temp sensor
8	HWX20003933	Terminal block 3 connections	35	HWX32010120023	PVC-Titanium Condenser
9	HWX20003504	Compressor capacitor (35µF)	36	HWX20003603	Low pressure switch
10	HWX20003510	Compressor capacitor (60µF)	37	HWX20011491	4 ways valve
11	HWX20000350011	Starting capacitor (193µF)	38	HWX20000140346	Electronic expansion valve
12	HWX20003254	EMC filter	39	HWX20000140353	HP&LP pressure gauge
13	HWX200036007	Compressor contactor	40	HWX20000140353	HP&LP pressure gauge
14	HWX32010210013	Right panel	41	HWX200036005	Flow switch
15	HWX20003151	Soft Starter	42	HWX20003242	Water outlet temp sensor
16	HWX200037003	Transformer 230V $\sqrt{\text{V}}$ -12V $\sqrt{\text{V}}$	43	HWX32019210061	Bottom panel
17	HWX32009220032	Protection cover	44	HWX32019210049	Front panel
18	HWX32019210025	Electrical box cover	45	HWX32019210026	Center Wall
19	HWX20001440	Liquid tank	46	HWX20000230596	Hayward logo
20	HWX32019220001	Top cover	47	HWX20000220169	Fan protection grille
21	HWX95053114512E	PCB Board	48	HWX32019210022	Fan motor bracket
22	HWX950531024103	Fan DC Inverter Module	49	HWX20000330132	DC Motor
*23*	HWX20003223	Compressor probe 50k $\Omega$	*50*	HWX20002625	Silent bloc
24	/		*51*	HWX200026009	O Ring ID 48-Ep 5mm
25	HWX9505010018	LED Controller	*52*	HWX200026061	O Ring ID 43-Ep 3.4mm
26	HWX32019210030	Crossbar Large	*53*	HWX20000240112	Wintering cover
27	HWX32019210029	Crossbar Small	*54*	HWX20001345	Condensor Drain Plug

Note: The \*xx\* markers are not indicated on the corresponding exploded view.

# 6. APPENDIX (continued)

## ENP6TASC

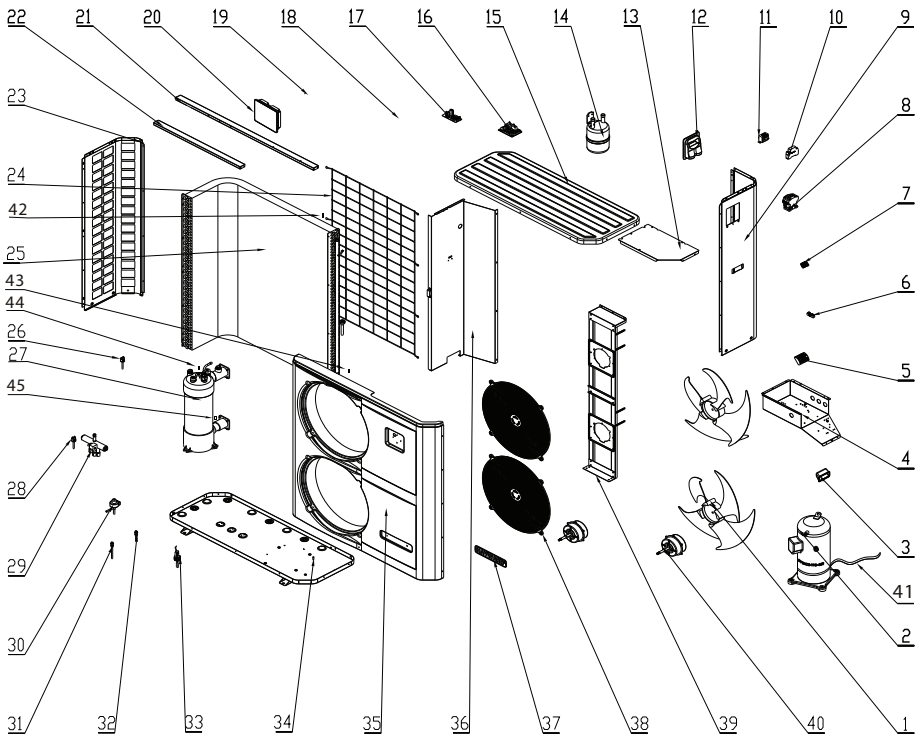

## 6. APPENDIX (continued)

### ENP6TASC

Mark	Ref.	Description	Mark	Ref.	Description
1	HWX20000270004	Fan blade	26	HWX20013605	High pressure switch
2	HWX20000110146	Compressor	27	HWX32019120007	PVC-Titanium Condenser
3	HWX32008220037	Handle	28	HWX20003603	Low pressure switch
4	HWX32019210024	Electrical box	29	HWX20011491	4 ways valve
5	HWX20003902	Terminal block 5 connections Tri	30	HWX20000140346	Electronic expansion valve
6	HWX20003909	Terminal block 2 connections	31		/
7	HWX20003933	Terminal block 3 connections	32		/
8	HWX20003653	Compressor contactor Tri	33	HWX200036005	Water flow rate detector
9	HWX32019210027	Right panel	34	HWX32019210061	Bottom
10	HWX200036023	Phase controller	35	HWX32019210049	Front panel
11	HWX200037003	Transformer 230V $\sphericalangle$ -12V $\sphericalangle$	36	HWX32019210026	Center Wall
12	HWX32009220032	Protection cover	37	HWX20000230596	Hayward logo
13	HWX32019210025	Electrical box cover	38	HWX20000220169	Fan protection grille
14	HWX20001440	Liquid tank	39	HWX32019210022	Fan motor bracket
15	HWX32019220001	Top cover	40	HWX20000330132	DC Motor
16	HWX95053114510E	PCB Board	41	HWX20003214	Crankcase heater
17	HWX950531024101	Fan DC Inverter Module	42	HWX20003242	Ambiente temp sensor
*18*	HWX20003223	Compressor probe 50k $\Omega$	43		Coi temp sensor
19	/		44		Water inlet temp Sensor
20	HWX95005010018	LED Controller	45		Water outlet temp sensor
21	HWX32019210030	Crossbar Large	*46*	HWX20002625	Silent bloc
22	HWX32019210029	Crossbar Small	*47*	HWX200026009	O Ring ID 48-Ep 5mm
23	HWX32019210028	Left Panel	*48*	HWX200026061	O Ring ID 43-Ep 3.4mm
24	HWX32019210031	Coil protection	*49*	HWX20000240112	Wintering cover
25	HWX32010120008	Fin coil	*50*	HWX20001345	Condensor Drain Plug

Note: The \*xx\* markers are not indicated on the corresponding exploded view.

## 6. APPENDIX (continued)

### ENP7TASC

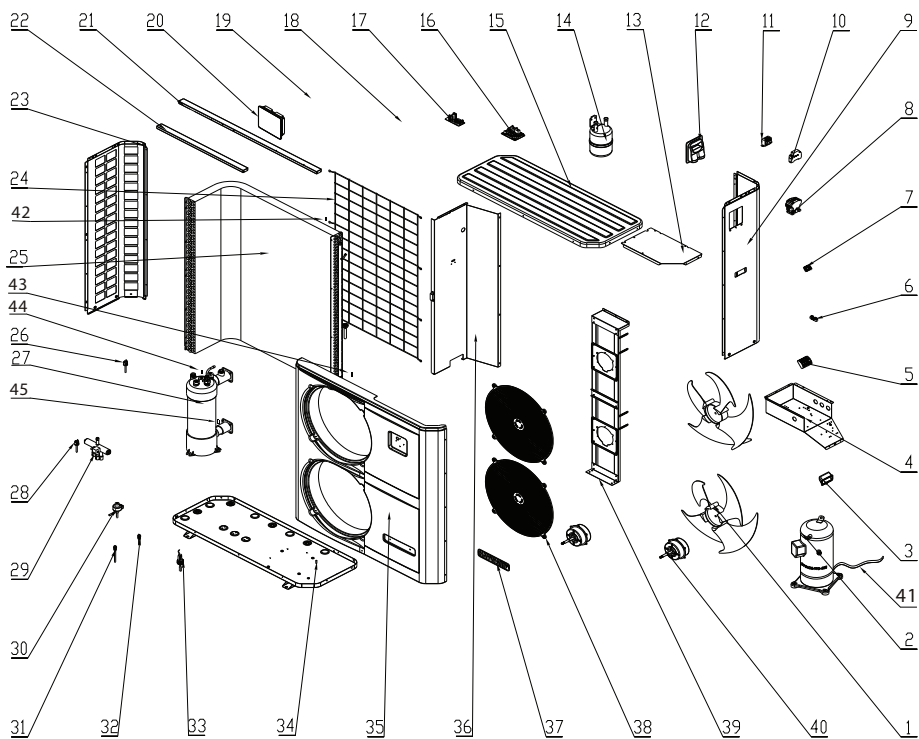



## 6. APPENDIX (continued)

### ENP7TASC

Mark	Ref.	Description	Mark	Ref.	Description
1	HWX20000270004	Fan blade	26	HWX20013605	High pressure switch
2	HWX20000110138	Compressor	27	HWX32019120007	PVC-Titanium Condenser
3	HWX32008220037	Handle	28	HWX20003603	Low pressure switch
4	HWX32019210024	Electrical box	29	HWX20011491	4 ways valve
5	HWX20003902	Terminal block 5 connections Tri	30	HWX20000140398	Electronic expansion valve
6	HWX20003909	Terminal block 2 connections	31		/
7	HWX20003933	Terminal block 3 connections	32		/
8	HWX20003653	Compressor contactor Tri	33	HWX200036005	Flow switch
9	HWX32019210027	Right panel	34	HWX32019210061	Bottom panel
10	HWX200036023	Phase controller	35	HWX32019210049	Front panel
11	HWX200037003	Transformer 230V $\sqrt{v}$ -12V $\sqrt{v}$	36	HWX32019210026	Center Wall
12	HWX32009220032	Protection cover	37	HWX20000230596	Hayward logo
13	HWX32019210025	Electrical box cover	38	HWX20000220169	Fan protection grille
14	HWX20001440	Liquid tank	39	HWX32019210022	Fan motor bracket
15	HWX32019220001	Top cover	40	HWX20000330132	DC Motor
16	HWX95053114511E	PCB Board	41	HWX20003214	Crankcase heater
17	HWX950531024102	Fan DC Inverter Module	42	HWX20003242	Ambiente temp sensor
*18*	HWX20003223	Compressor probe 50k $\Omega$	43		Coi temp sensor
19	/	/	44		Water inlet temp Sensor
20	HWX95005010018	LED Controller	45		Water outlet temp sensor
21	HWX32019210030	Crossbar Large	*46*	HWX20002625	Silent bloc
22	HWX32019210029	Crossbar Small	*47*	HWX200026009	O Ring ID 48-Ep 5mm
23	HWX32019210028	Left Panel	*48*	HWX200026061	O Ring ID 43-Ep 3.4mm
24	HWX32019210031	Coil protection	*49*	HWX20000240112	Wintering cover
25	HWX32019120002	Fin coil	*50*	HWX20001345	Condensor Drain Plug

Note: The \*xx\* markers are not indicated on the corresponding exploded view.

# 6. APPENDIX (continued)

---

## 6.4 Troubleshooting guide



***Certain operations must be carried out by an authorized technician.***

In case of a fault, the following signs are displayed on the screen:

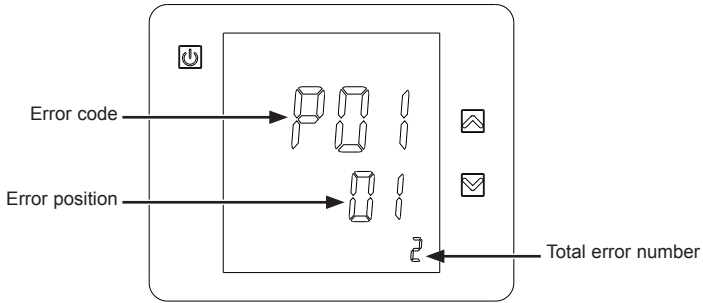

In the case of multiple errors, press on  or  to scroll through the error codes. Refer to following table.

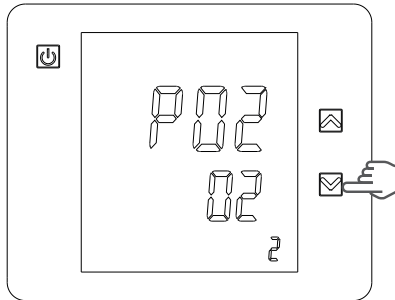

<b>Problem</b>	<b>Error codes</b>	<b>Description</b>	<b>Solution</b>
Water inlet sensor defect.	P01	The sensor is open or presents a short-circuit.	Verify or replace the sensor.
Water outlet sensor defect.	P02	The sensor is open or presents a short-circuit.	Verify or replace the sensor.
De-icing sensor defect.	P05	The sensor is open or presents a short-circuit.	Verify or replace the sensor.
Exterior temperature sensor defect.	P04	The sensor is open or presents a short-circuit.	Verify or replace the sensor.
Compressor aspiration sensor defect	P07	The sensor is open or presents a short-circuit.	Verify or replace the sensor.
The inlet and outlet difference in water temperature is too high.	E06	Water flow volume is insufficient, water pressure difference is too low/ too high.	Verify the water flow, or system obstruction.
Antifreeze Protection Cold mode	E07	Water outlet quantity is too weak.	Verify the water flow, or the outlet water temperature sensor.
Level 1 antifreeze protection	E19	Air temperature or water inlet temperature is too weak.	
Level 2 antifreeze protection	E29	Air temperature or water inlet temperature is still too weak.	
High pressure protection	E01	Pressure of the refrigeration circuit is too high, or the water flow is too low, or the coil is obstructed or the air flow is too weak.	Verify the high pressure switch and the refrigeration circuit pressure. Verify the water or air flow. Verify that the flow switch is working correctly. Verify the water inlet/outlet valve openings. Verify the by-pass setting.
Low pressure protection	E02	Refrigeration circuit pressure is too weak, or air flow is too weak or the coil is obstructed.	Verify the low pressure switch and the refrigeration circuit pressure to determine if there is a leak. Clean the coil surface. Verify the fan rotation speed. Verify that there is free air flow to the coil.
Flow detector defect	E03	Water flow is insufficient or the detector is in short-circuit or defective.	Verify the water flow, verify the filtration pump and the flow detector to see if they have any possible problems.
Communication problem	E08	Problem with the LED controller or the PCB connection.	Check the connection of the NET and NET 1 cables.
The compressor will not start	E08	Phase missing or phase order incorrect	check that the 3 phases are present modify the phase order at the heat pump's electrical connection terminal block

## 6. APPENDIX (continued)

---

### 6.5 Warranty

#### WARRANTY CONDITIONS

HAYWARD warrants its products free from defects in material and workmanship for a period of two years from the date of purchase. A purchase proof with its date must be enclosed for any request for warranty. We invite you to keep your receipt.

HAYWARD warranty is limited to the replacement or repair, at its option, of defective products that have been used in normal conditions and according to the instructions leaflet, with no change in the product and that have been working only with genuine HAYWARD parts. Frost and chemical reaction damages are excluded of the warranty.

HAYWARD will not be responsible for any other costs (removal, labor...), neither direct or indirect damages caused by malfunction of a product.

To initiate a warranty claim and ask for repair or replacement of a product, please contact your dealer. No shipment to our factory will be accept without our preliminary written acceptance.

Wear parts are excluded of the warranty.

ISENPASC Rev C

# ***ENERGYLINE PRO***

**UNIDAD DE BOMBA DE CALOR PARA PISCINAS**



**Manual de Instalación e Instrucciones**

# ÍNDICE

---

<b>1. Prefacio</b>	<b>1</b>
<hr/>	
<b>2. Características técnicas</b>	<b>2</b>
2.1 Datos técnicos de la bomba de calor	2
2.2 Margen de funcionamiento	3
2.3 Dimensiones	4
<hr/>	
<b>3. Instalación y conexión</b>	<b>5</b>
3.1 Esquema eléctrico	5
3.2 Bomba de calor	6
3.3 Conexión hidráulica	6
3.4 Conexión eléctrica	7
3.5 Primer arranque	8
3.6 Ajuste del caudal de agua	10
<hr/>	
<b>4. Interfaz usuario</b>	<b>11</b>
4.1 Presentación general	11
4.2 Ajuste del reloj	13
4.3 Ajuste de la función Timer	13
4.4 Elección del modo de funcionamiento	14
4.5 Ajuste y visualización del punto de referencia	15
4.6 Apertura y bloqueo automático de la pantalla táctil	15
4.7 Ajuste del modo silencioso	16
<hr/>	
<b>5. Mantenimiento e invierno</b>	<b>19</b>
5.1 Mantenimiento	19
5.2 Invierno	19
<hr/>	
<b>6. Anexos</b>	<b>20</b>
6.1 Esquemas eléctricos	20
6.2 Conexiones prioridad calentamiento	22
6.3 Despiece y piezas de recambio	24
6.4 Guía de reparación	30
6.5 Garantía	33

Leer atentamente y conservar para consultar con posterioridad.

Este documento debe suministrarse al propietario de la piscina y debe ser conservado por éste en un lugar seguro.

# 1. PREFACIO

---

Le agradecemos que haya comprado esta bomba de calor para piscinas Hayward. Este producto ha sido creado siguiendo estrictas normas de fabricación que satisfacen los niveles de calidad exigidos. El presente manual incluye toda la información necesaria para la instalación, solución de fallos de funcionamiento y mantenimiento. Lea atentamente este manual antes de abrir la unidad, o de realizar las operaciones de mantenimiento de ésta. El fabricante de este producto no se responsabiliza de cualquier daño que pudiera sufrir un usuario o del deterioro de la unidad que esté causado por una mala instalación, por la solución de fallos de funcionamiento o que se deba a un mal mantenimiento. Es primordial que siga en todo momento las instrucciones que se especifican en este manual. La unidad debe ser instalada por personal cualificado.

- Las reparaciones deben ser efectuadas por personal cualificado.
- Todas las conexiones eléctricas deben ser efectuadas por un electricista profesional cualificado y deben realizarse cumpliendo con las normas en vigor en el país de instalación § 3.4.
- El mantenimiento y las diferentes operaciones deben ser realizadas con la frecuencia y en los momentos recomendados que se especifican en el presente manual.
- Utilice solamente piezas de repuesto originales
- El no seguir cualquiera de estas recomendaciones supone la anulación de la garantía.
- Esta bomba de calor calienta el agua de la piscina y mantiene una temperatura constante, no utilizarla para otros fines.

Tras leer este manual, téngalo a mano para poder utilizarlo con posterioridad.

Advertencia relativa a niños/ personas con limitaciones físicas:

Este aparato no está destinado al uso de personas (en particular niños) que tengan cualquier limitación en su capacidad física, sensorial o intelectual, ni para el uso de personas sin experiencia ni conocimientos, a menos que actúen bajo supervisión o hayan recibido, de una persona responsable de su seguridad, las instrucciones relativas a la utilización del equipo.

Este producto contiene gases de efecto invernadero enmarcados dentro del protocolo de Kyoto

Tipo de refrigerante: R410A

Valor GWP<sup>(1)</sup>: 1975

Las inspecciones periódicas de fugas de refrigerante pueden ser requeridas por la legislación europea o local. Póngase en contacto con su distribuidor local para obtener más información.

---

1) Potencia global de calentamiento

## 2. CARACTERÍSTICAS TÉCNICAS

---

### 2.1 Datos técnicos de la bomba de calor

Modelos	ENERGYLINE PRO	ENP6MASC	ENP6TASC	ENP7TASC
Capacidad calorífica *	kW	17,8	18,2	23,4
Potencia eléctrica absorbida *	kW	3,69	3,7	5,15
Corriente de funcionamiento *	A	16,2	7,69 / 6,89 / 6,33	9,71 / 8,01 / 7,70
Tensión de alimentación	V Ph/Hz	230V∨ 50Hz	400V 3N∨ 50Hz	400V 3N∨ 50Hz
Calibre de fusible tipo aM	A	20	12	16
Disyuntor curva D	A	20	12	16
Número de compresores		1	1	1
Tipo de compresor		Scroll	Scroll	Scroll
Número de ventiladores		2	2	2
Potencia del ventilador	W	50 — 225	50 — 225	50 — 225
Velocidad de rotación de los ventiladores	RPM	600 — 950	830 — 960	800 — 1050
Ventilación		Horizontal	Horizontal	Horizontal
Nivel de presión acústica (a 1 metro)	dB(A)	45	45	47
Conexión hidráulica	mm	50	50	50
Caudal nominal de agua*	m <sup>3</sup> /h	6,6	6,6	8
Pérdida de carga sobre el agua (max)	kPa	7	7	18
Dimensiones netas de la unidad (L/a/a)	mm	1138 / 470 / 1264	1138 / 470 / 1264	1138 / 470 / 1264
Peso neto de la unidad	kg	127	123	140

\* Valor con +/- 5% en las siguientes condiciones: Temperatura exterior= 15°C (59°F) / HR = 71% / Temperatura de entrada de agua= 26°C (78,8°F).  
Conforme al referencial NF -414 (uso anual)





## 2. CARACTERÍSTICAS TÉCNICAS (continuación)

---

### 2.2 Margen de funcionamiento

Utilizar la bomba de calor dentro de los siguientes márgenes de temperatura y de humedad para garantizar un funcionamiento seguro y eficaz.

	Modo calentamiento 	Modo enfriamiento 
Temperatura exterior	-12°C ~ +35°C	+7°C ~ +43°C
Temperatura del agua	+12°C ~ +40°C	+8°C ~ +40°C
Humedad relativa	< 80%	< 80%
Margen de reglaje del punto de referencia	+15°C ~ +32°C	+8°C ~ +32°C



***Si la temperatura o la humedad no corresponden a estas condiciones, los dispositivos de seguridad pueden activarse y la bomba de calor puede no funcionar.***



***La temperatura máxima de calentamiento está limitada a 32°C para evitar el deterioro de los revestimientos. Hayward no se hace responsable en el caso de un uso por encima de +32°C.***

## 2. CARACTERÍSTICAS TÉCNICAS (continuación)

### 2.3 Dimensiones

Modelos: ENP6TASC / ENP7TASC

Unidad: mm

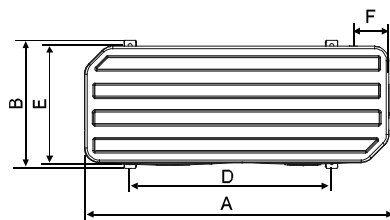
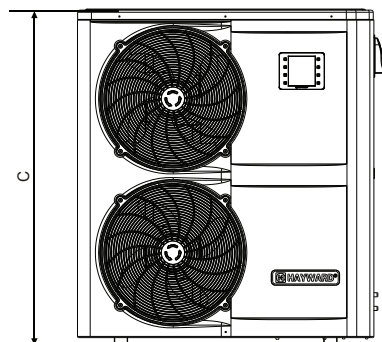
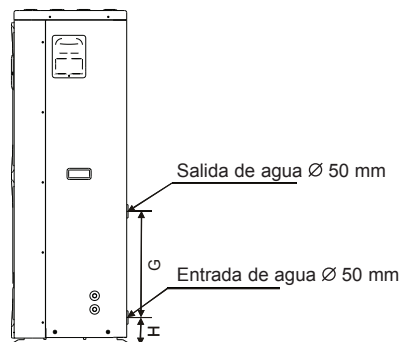

TIPO (mm)	ENP6MASC	ENP6TASC ENP7TASC
A	1138	1138
B	470	470
C	1264	1264
D	790	790
E	447	447
F	114	114
G	500	400
H	104	104

### 3. INSTALACIÓN Y CONEXIÓN

#### 3.1 Esquema eléctrico

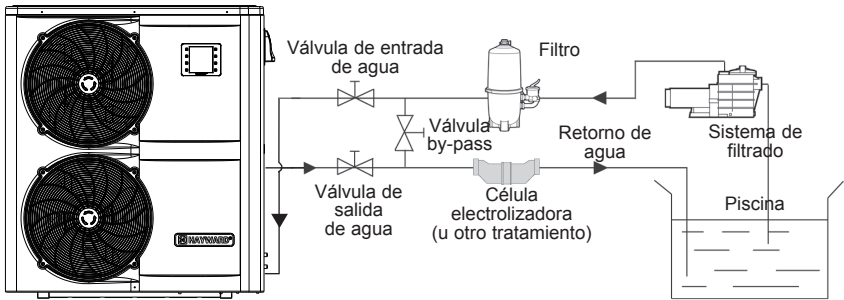

Nota: La bomba de calor se suministra sin ningún equipo de tratamiento o filtración. Los elementos que aparecen en el esquema son las piezas que deberá proporcionar el instalador.

#### 3.2 Bomba de calor



**Colocar la bomba de calor en el exterior y fuera de cualquier sala técnica cerrado.**

**Colocar en una zona resguarda, las distancias mínimas que a continuación se prescriben deben ser respetadas a fin de evitar cualquier riesgo de recirculación del aire y de una degradación del rendimiento global de la bomba de calor.**

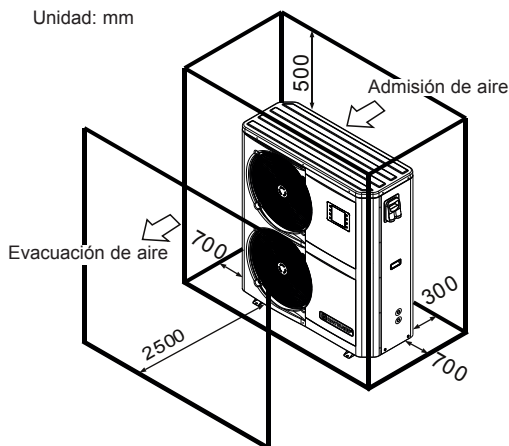

### 3. INSTALACIÓN Y CONEXIÓN (continuación)

---



**Preferiblemente instale la bomba de calor sobre una superficie de hormigón aislada o una silla de fijación prevista a tal fin y monte la bomba de calor sobre los silentblocs suministrados (los tornillos y arandelas no se suministran).**

**Distancia máxima de instalación entre la bomba de calor y la piscina 15 metros.**

**Longitud total de ida-vuelta de las canalizaciones hidráulicas 30 metros.**

**Aislar las canalizaciones hidráulicas de superficie y enterradas.**

#### 3.3 Conexión hidráulica

La bomba de calor se suministra con dos conexiones de unión de 50 mm de diámetro. Utilice un tubo de PVC para la canalización hidráulica Ø 50 mm. Conecte la entrada de agua de la bomba de calor al conducto proveniente del grupo de filtración, tras esto conecte la salida de agua de la bomba de calor al conducto de agua que va a la piscina (cf esquema de abajo).

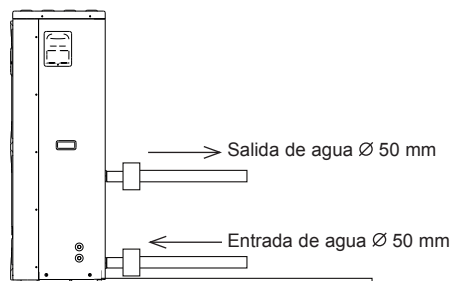

Instale una válvula "by-pass" entre la entrada y la salida de la bomba de calor.



**Si se utiliza un distribuidor automático o un electrolizador, se debe instalar obligatoriamente después de la bomba de calor con el fin de proteger el condensador de titanio de una concentración demasiado grande de producto químico.**



**Se ruega instale la válvula by-pass y las conexiones de unión suministradas al nivel de la entrada y la salida de agua de la unidad, con el fin de simplificar la purga durante el periodo invernal y de facilitar el acceso o el desmontaje para el mantenimiento.**

### 3. INSTALACIÓN Y CONEXIÓN (continuación)

#### 3.4 Conexión eléctrica



**La instalación eléctrica y el cableado de este equipo debe cumplir con la normativa de instalación local en vigor.**

F	NF C15-100	GB	BS7671:1992
D	DIN VDE 0100-702	EW	EVHS-HD 384-7-702
A	ÖVE 8001-4-702	H	MSZ 2364-702/1994/MSZ 10-553 1/1990
E	UNE 20460-7-702 1993, RECBT ITC-BT-31 2002	M	MSA HD 384-7-702.S2
IRL	Wiring Rules + IS HD 384-7-702	PL	PN-IEC 60364-7-702:1999
I	CEI 64-8/7	CZ	CSN 33 2000 7-702
LUX	384-7.702 S2	SK	STN 33 2000-7-702
NL	NEN 1010-7-702	SLO	SIST HD 384-7-702.S2
P	RSIUEE	TR	TS IEC 60364-7-702



**Compruebe que la alimentación eléctrica disponible y la frecuencia de la red corresponden con la corriente de funcionamiento requerida, teniendo en consideración el emplazamiento específico del aparato y la corriente necesaria para alimentar cualquier otro aparato que esté conectado al mismo circuito.**

**ENP6MASC 230 V $\sim$  +/- 10 % 50 Hz 1 Phase**

**ENP6TASC 400 V $\sim$  +/- 10 % 50 Hz 3 Phases**

**ENP7TASC 400 V $\sim$  +/- 10 % 50 Hz 3 Phases**



**Compruebe que el equilibrio de las fases no supera el 2 %**

**Observe el esquema de cableado correspondiente en el anexo.**

**La caja de conexiones se encuentra en el lado derecho de la unidad.**

**Hay tres conexiones destinadas a la alimentación eléctrica y dos para el control del sistema de filtrado (servomecanismo).**

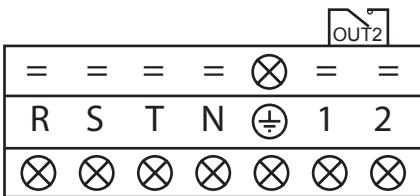

Alimentación general  
400V 3N $\sim$  50Hz

Contacto seco 7 A máx.  
libre de potencial  
Función prioridad  
del calentamiento

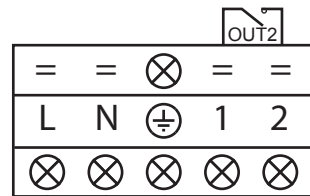

Alimentación general  
230V  $\sim$  / 50Hz

Contacto seco 7 A máx.  
libre de potencial  
Función prioridad  
del calentamiento

### 3. INSTALACIÓN Y CONEXIÓN (continuación)



**La línea de alimentación eléctrica debe estar dotada, de manera apropiada, de un dispositivo de protección del tipo fusible de acompañamiento del motor (aM) o disyuntor curva D, así como de un disyuntor diferencial 30mA (ver tabla a continuación).**

Modelos		ENP6MASC	ENP6TASC	ENP7TASC
Alimentación eléctrica	V/Ph/Hz	230V~/ 50Hz	400V 3N~/ 50Hz	400V 3N~/ 50Hz
Calibre de fusible tipo aM	A	20 aM	12 aM	16 aM
Disyuntor curva D	A	20 D	12 D	16 D
Sección de cable	mm <sup>2</sup>	3G6 3 x 6	5G2,5 5 x 2,5	5G2,5 5 x 2,5



**Use un cable de alimentación de tipo RO 2 V / R 2 V o equivalente.**



**Las secciones de cable indicadas se corresponden a una longitud máxima de 25 m. Sin embargo, deben comprobarse y adaptarse en función de las condiciones de instalación.**



**Tenga siempre cuidado de detener la alimentación principal antes de abrir la caja de control eléctrico.**

#### 3.5 Primer arranque

Procedimiento de arranque - una vez que se ha terminado la instalación, siga y respete las siguientes etapas:

- 1) Gire los ventiladores con la mano para comprobar que pueden girar libremente y que la hélice está correctamente fijada al árbol del motor.
- 2) Asegúrese de que la unidad está conectada correctamente a la alimentación principal (ver el esquema de cableado en el anexo).
- 3) Active el sistema de filtrado.
- 4) Verifique que todas las válvulas de agua están abiertas y que el agua circula hacia la unidad antes de pasar al modo de calentamiento o enfriamiento.
- 5) Verifique que la acometida de purga de condensados está fijada correctamente y no presenta ninguna obstrucción.
- 6) Activar la alimentación eléctrica destinada a la unidad, después presione el botón de Marcha/Parada  sobre el panel de control.

### 3. INSTALACIÓN Y CONEXIÓN (continuación)

- 7) Asegúrese de que ningún código de ALARMA se activa cuando la unidad está en ON (ver guía de reparación).
- 8) Fije el caudal de agua con la ayuda de la válvula by-pass (ver § 3.6 y 2.1), tal y como se prevee respectivamente para cada modelo de manera que obtenga una diferencia de temperatura Entrada/ Salida de 2°C.
- 9) Tras estar funcionando unos cuantos minutos, verifique que el aire sale de la unidad y se enfría (entre 5 y 10°).
- 10) Estando la unidad en servicio, desactive el sistema de filtrado. La unidad debe pararse automáticamente y mostrar el código de error E03.
- 11) Haga funcionar la unidad y la bomba de la piscina durante 24 horas seguidas, hasta que se alcance la temperatura del agua deseada. Cuando la temperatura de entrada del agua alcance el valor de referencia, la unidad se para. Se pone en funcionamiento de nuevo automáticamente (siempre que la bomba de la piscina esté en servicio) si la temperatura desciende menos de 0,5°C por debajo de la temperatura de referencia.

**Controlador del caudal** - La unidad está dotada de un controlador de caudal que activa la bomba de calor mientras el sistema de filtrado de la piscina está en servicio y la desactiva cuando el sistema de filtrado está fuera de servicio. Por falta de agua, el código de alarma E03 aparece en el reguador (Ver § 6.4).

**Temporización** - la unidad integra una temporización de 3 minutos, que tiene por objeto proteger los componentes del circuito de control, eliminar cualquier inestabilidad en el arranque y cualquier interferencia del contactor. Por medio de esta temporización, la unidad arranca de nuevo automáticamente unos 3 minutos después de que se produzca un corte del circuito de control. Incluso un corte de corriente de corta duración activa la temporización de arranque.

**Controlador de fase** - Las unidades trifásicas integran un controlador de fase para garantizar que la rotación del compresor se realiza en el sentido correcto.

Si la unidad no arranca, compruebe el estado del controlador de fase situado en la caja eléctrica.

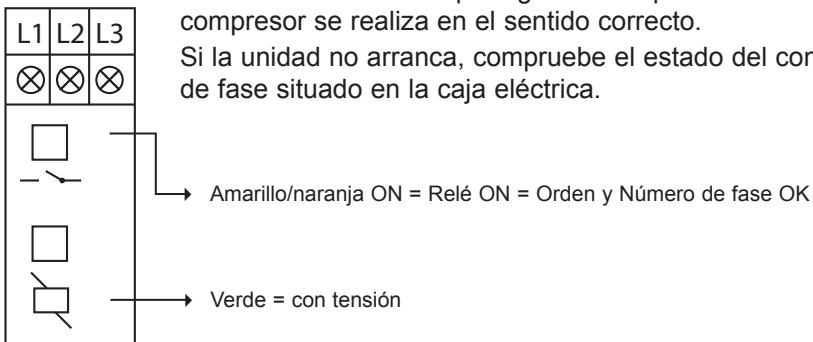

### 3. INSTALACIÓN Y CONEXIÓN (continuación)

---

#### 3.6 Ajuste del caudal de agua

Con las válvulas de entrada y salida de agua abiertas, ajustar la válvula "by-pass" de forma que se obtenga una diferencia de 2°C entre la temperatura de entrada y de la salida del agua (ver el esquema eléctrico § 3.1). Puede verificar el ajuste visualizando las temperaturas de entrada/salida directamente sobre el panel de control.

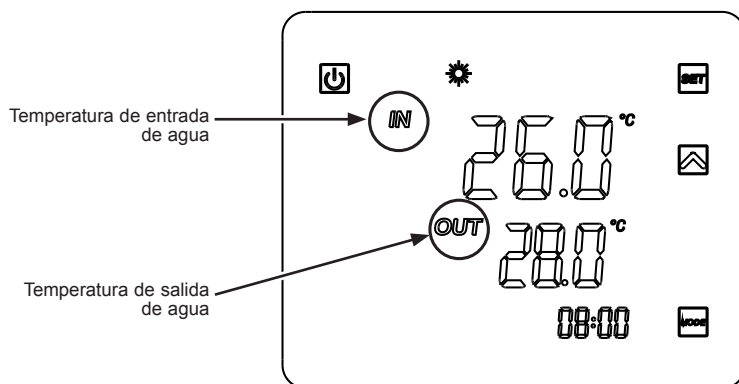

Nota: La apertura de la válvula "by-pass" genera un caudal menor, lo cual conlleva un aumento de  $\Delta T$ .  
El cierre de la válvula "by-pass" genera un caudal mayor, lo cual conlleva una disminución de  $\Delta T$ .



# 4. INTERFAZ USUARIO

## 4.1 Presentación general

La bomba de calor está equipada con un panel de control digital con pantalla táctil, el cual ha sido previamente conectado eléctricamente y programado en fábrica para funcionar en modo calentamiento.

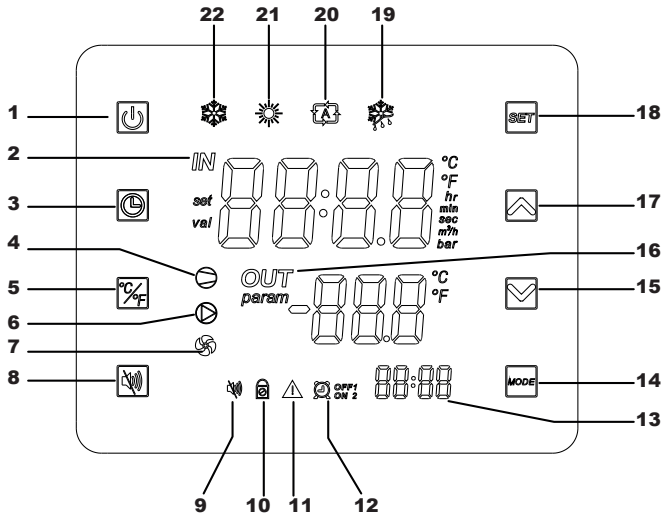

### Legenda

1		Marcha/ Parada	12		Timers 1 y 2 (temporizadores)
2	<i>IN</i>	Entrada de agua	13		Hora de los Timers
3		Ajuste hora y Timers	14		Selección del modo
4		Compresor ON	15		Desfilar abajo / Reducir
5		Conversión °C/°F	16	<i>OUT</i>	Salida de agua
6		Contacto seco OUT2	17		Desfilar arriba / Aumentar
7		Ventilador ON	18		Validar / Ajustar
8		Modo silencioso	19		Modo deshielo
9		Testigo modo silencioso	20		Modo automático
10		Pantalla bloqueada	21		Modo calentamiento
11		Alarma	22		Modo enfriamiento

## 4. INTERFAZ USUARIO (continuación)

---

### Modo OFF

Cuando la bomba de calor está en espera (Modo OFF) aparece "OFF" en la pantalla del regulador.

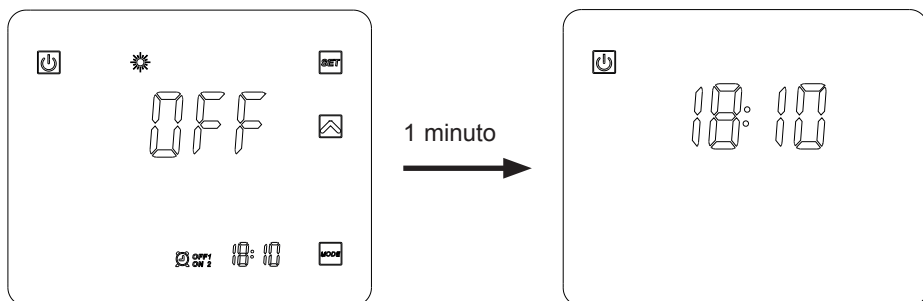

### Modo ON

Cuando la bomba de calor está en funcionamiento o en regulación (Modo ON) las temperaturas de entrada y salida del agua aparecen en la pantalla del regulador.

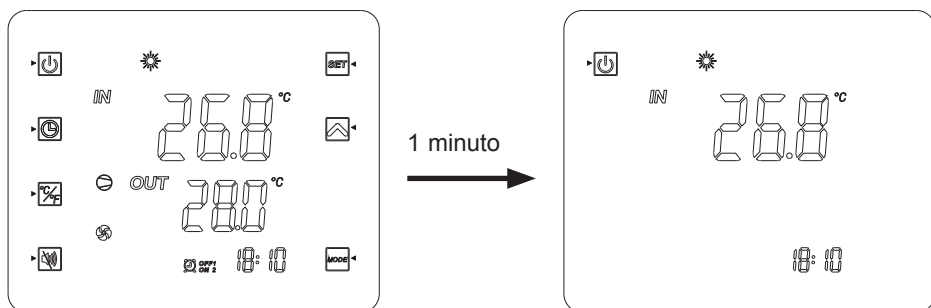









## 4. INTERFAZ USUARIO (continuación)

Al final de la configuración, presione  para validar.

El registro es automático si no se presiona ningún botón en 20 s.

### 2 Ajuste del reloj

Si el visualizador está en modo de espera, se debe pulsar brevemente .









- 1) Presione  para que aparezca el símbolo .
- 2) Presione , la visualización de la hora parpadea. Ajustar las horas con los botones  .
- 3) Presione  y después ajustar los minutos con los botones  .
- 4) Validar pulsando .

### 4.3 Ajuste de la función Timer











El ajuste de esta función será necesario cuando usted desee hacer funcionar su bomba de calor durante un periodo de tiempo más corto que el determinado por el reloj de filtración. De esta forma podrá programar un arranque retardado y una parada anticipada o simplemente prohibir un periodo horario de funcionamiento (por ejemplo la noche).



Tiene la posibilidad de programar 2 Timers de Marcha (ON1 y ON2) y 2 Timers de Parada (OFF1 y OFF2)..

#### Programación del Timer 1 – Marcha

- 1) Presione  durante 2 s, el Timer ON1  <sup>1</sup> parpadea (\*).
- 2) Presione  para ajustar las horas con los botones  .
- 3) Presione  para ajustar los minutos con los botones  .
- 4) Validar pulsando .



#### Programación del Timer 1 – Parada

- 1) Presione  durante 2 s, el Timer ON1  <sup>1</sup> parpadea (\*).  
Presione 1 una vez , el Timer OFF1  <sup>OFF1</sup> parpadea.
- 2) Presione  para ajustar las horas con los botones  .
- 3) Presione  para ajustar los minutos con los botones  .
- 4) Validar pulsando .



(\*) Para acceder directamente al Timer ON2  <sup>ON 2</sup>, pulsar  durante 2 s, y después pulsar 2 veces .

## 4. INTERFAZ USUARIO (continuación)

















### Programación del Timer 2

Después de los ajustes del Timer 1, se accede directamente a los ajustes del Timer 2: :  y .

Proceder de la misma manera que para el Timer 1.

**Nota:** Para acceder directamente al Timer ON2 , pulsar  durante 2 s, y después pulsar 2 veces .

### Supresión de los Timers (Marcha y Parada)

- 1) Presione  durante 2 s, el Timer ON1  parpadea.(\*)
  - 2) Presione , la visualización de la hora parpadea.
  - 3) Presione  para cancelar el Timer .
  - 4) Presione  para confirmar.
  - 5) Presione  durante 2 s, el Timer ON1  parpadea.  
Presione una vez , el Timer  parpadea.(\*)
  - 6) Presione , la visualización de la hora parpadea.
  - 7) Presione  para cancelar el Timer .
- (\*) Para acceder a los Timers 2  o , siga las etapas 1)- 4) y después pulse 2 veces . Proceder de la misma manera que anteriormente.

### 4.4 Elección del modo de funcionamiento: enfriamiento, calentamiento o automático

#### En Modo "OFF" o "ON"

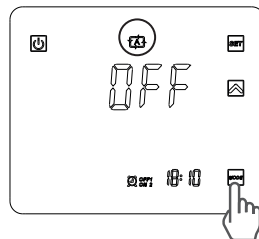
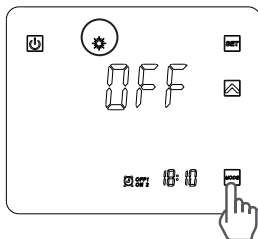
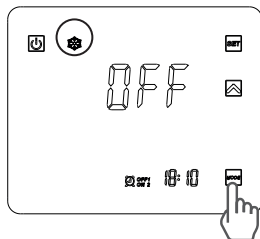

Presione el botón  para cambiar del modo : enfriamiento, calentamiento o automático.



**Si la bomba de calor se encuentra en sólo calefacción o refrigeración sólo en el modo, el cambio de modo no es posible.**



## 4. INTERFAZ USUARIO (continuación)

### 4.5 Ajuste y visualización del punto de referencia (Temperatura del agua deseada)

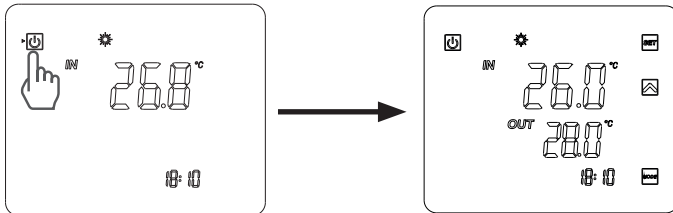
Si el botón  no está visible en la pantalla, se debe pulsar brevemente .  
(En funcionamiento o en parada, basta con pulsar el botón  para visualizar el punto de consigna.)





#### En Modo “OFF” y Modo “ON”



Presione  para visualizar el punto de consigna, y después pulsar  o  para definir el punto de consigna deseado.  
El ajuste se efectúa con una precisión de 0,5 °C.



***Se recomienda no sobrepasar jamás la temperatura de 30°C para evitar la alteración de los liners.***

### 4.6 Apertura y bloqueo automático de la pantalla táctil

Presione el botón  durante 5 s hasta que emita un bip y aparezca el símbolo .

Para el desbloqueo automático, presione  durante 5s hasta que emita un bip y desaparezca el símbolo .

## 4. INTERFAZ USUARIO (continuación)

### 4.7 Ajuste del modo silencioso (🔇)

Esta función permite el uso de la bomba de calor con una velocidad de rotación de los ventiladores reducida a 600 rpm para el ENP6MASC, 830 rpm para el ENP6TASC y 800 rpm para el ENP7TASC durante un tiempo de 8 horas como máximo, con el objetivo de limitar el ruido durante la noche o el día según la ubicación de la bomba de calor con relación al vecindario y/o la piscina.



Esta función se puede Activar / Desactivar manualmente o con un temporizador.

#### Activación manual

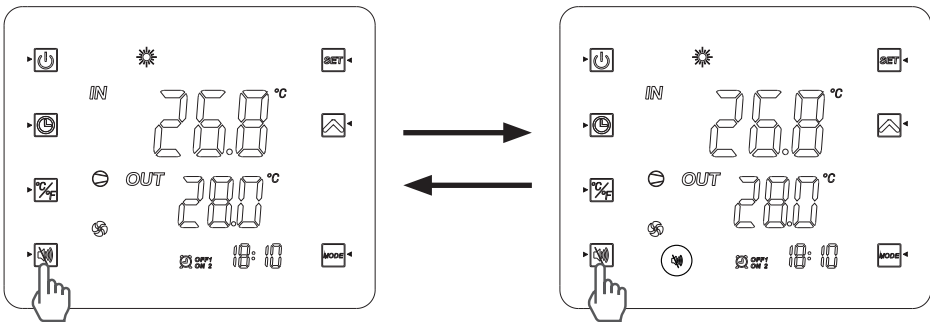
- 1) Pulsar el botón .
- 2) La visualización siguiente aparece en la pantalla, el modo Silencio se activa durante las siguientes 8 horas.
- 3) Los ventiladores reducen progresivamente su velocidad de rotación durante un tiempo máximo de 8 horas.
- 4) Tras 8 horas de funcionamiento, la función se desactivará automáticamente y la velocidad de rotación de los ventiladores dependerá de la temperatura del aire exterior.





#### Desactivación manual

- 1) Pulsar el botón .
- 2) El testigo  desaparece de la pantalla: el modo Silencio se desactiva.
- 3) Los ventiladores ajustan su velocidad de rotación en función de la temperatura del aire exterior.

## 4. INTERFAZ USUARIO (continuación)





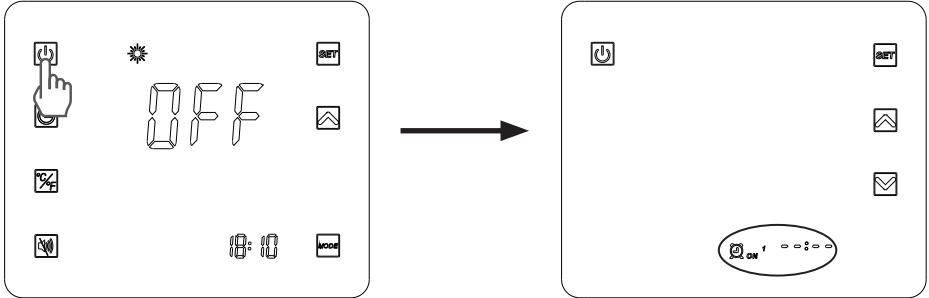

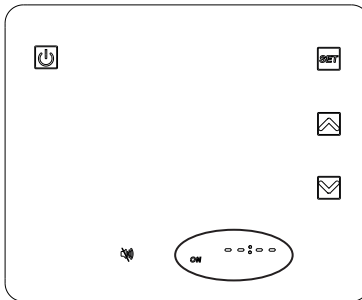

### Programación del modo SILENCIO

1) Presione  durante 2s : el Timer ON1  ON <sup>1</sup> parpadea.



2) Pulsar 4 veces  hasta la pantalla siguiente.





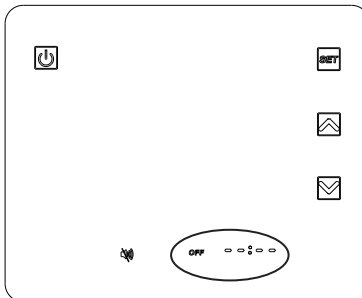





- 3) Presione , las horas parpadean. Usar las flechas   para ajustar la hora de inicio.
- 4) Presione , los minutos parpadean. Usar las flechas   para ajustar los minutos de inicio. Validar pulsando .
- 5) Presione  para ajustar la hora de fin: la indicación OFF parpadea.



## 4. INTERFAZ USUARIO (continuación)

---

- 6) Presione , las horas parpadean. Usar las flechas   para ajustar la hora de finalización.
- 7) Presione , los minutos parpadean. Usar las flechas   para ajustar los minutos de finalización. Validar pulsando .
- 8) Presione  para confirmar y volver a la pantalla anterior.  
Las indicaciones ON-OFF se visualizan como a continuación.

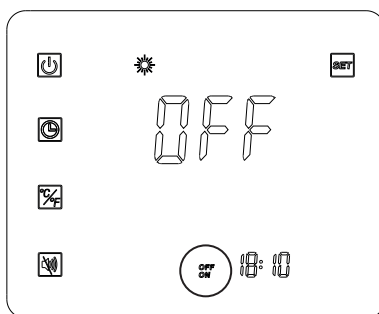

**Nota :** Los minutos se ajustan de 10 en 10.

Una vez finalizado el ajuste del modo SILENCIOSO, por defecto, permanece activo los 7 días de la semana.



## 5. MANTENIMIENTO E INVIERNO

---

### 5.1 Mantenimiento

Estas operaciones de mantenimiento deben realizarse 1 vez al año con el fin de garantizar la longevidad y el buen funcionamiento de la bomba de calor.

- Limpie el evaporador con un cepillo flexible o de un chorro de aire o agua (**Atención no utilizar jamás un limpiador de alta presión**).
- Verifique el buen flujo de los condensados.
- Compruebe la fijación de las conexiones hidráulicas y eléctricas
- Compruebe la estanqueidad hidráulica del condensador.



***Antes de realizar cualquier operación de mantenimiento, la bomba de calor debe estar desconectada de cualquier fuente de corriente eléctrica. Las operaciones de mantenimiento deben ser realizadas únicamente por personal cualificado y capacitado para manipular fluidos frigorígenos.***

### 5.2 Invierno

- Poner la bomba de calor en Modo "OFF".
- Cortar la alimentación de la bomba de calor.
- Vaciar el condensador a través del desagüe para evitar cualquier riesgo de degradación. (riesgo importante de congelación).
- Cerrar la válvula "by-pass" y desatornillar las conexiones de unión entrada/salida.
- Expulse toda el agua estancada residual del condensador ayudándose con una pistola de aire.
- Obtura la entrada y la salida de agua a la bomba de calor para evitar la intrusión de cuerpos extraños.
- Cubrir la bomba de calor con una funda de protección para el invierno.



***Cualquier daño ocasionado por un mal mantenimiento invernal conlleva la anulación de la garantía.***

# 6. ANEXOS

## 6.1 Esquemas eléctricos

### ENP6MASC

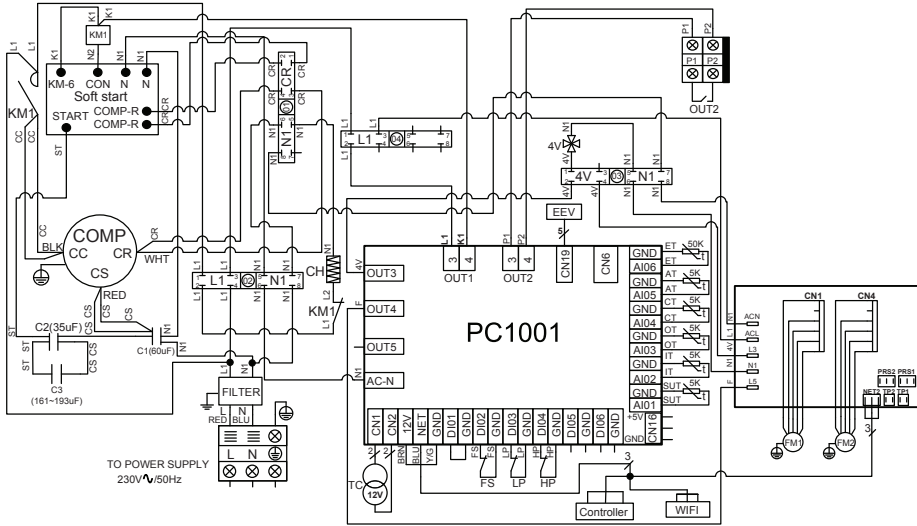

**OBSERVACIONES:**

- 1. AT : SONDA DE TEMPERATURA DE AIRE
- 2. COMP : COMPRESOR
- 3. CT : SONDA DE TEMPERATURA EVAPORADOR
- 4. EEV : DESCOMPRESOR ELECTRÓNICO
- 5. FM1-2 : MOTOR VENTILADOR
- 6. FS : DETECTOR DE PRESENCIA DE AGUA
- 7. HP : PRESOSTATO ALTA PRESIÓN
- 8. IT : SONDA DE TEMPERATURA DE ENTRADA DE AGUA
- 9. LP : PRESOSTATO BAJA PRESIÓN

- 10. OT : SONDA DE TEMPERATURA DE ENTRADA DE AGUA
- 11. SUT : SONDA DE TEMPERATURA DE ASPIRACIÓN
- 12. TC : TRANSFORMADOR 230V $\nu$  / 12V $\nu$
- 13. 4V : VÁLVULA 4 VÍAS
- 14. KM1 : CONTACTOR DE POTENCIA
- 15. SOFT START : ARRANCADOR ELECTRÓNICO
- 16. CH : RESISTENCIA CARTER
- 17. OUT2 : CONTACTO SECO LIBRE DE 7 A MÁX. DE POTENCIAL
- 18. ET : SONDA DE TEMPERATURA DE DESCARGA

# 6. ANEXOS (continuación)

## 6.1 Esquemas eléctricos

### ENP6TASC - ENP7TASC

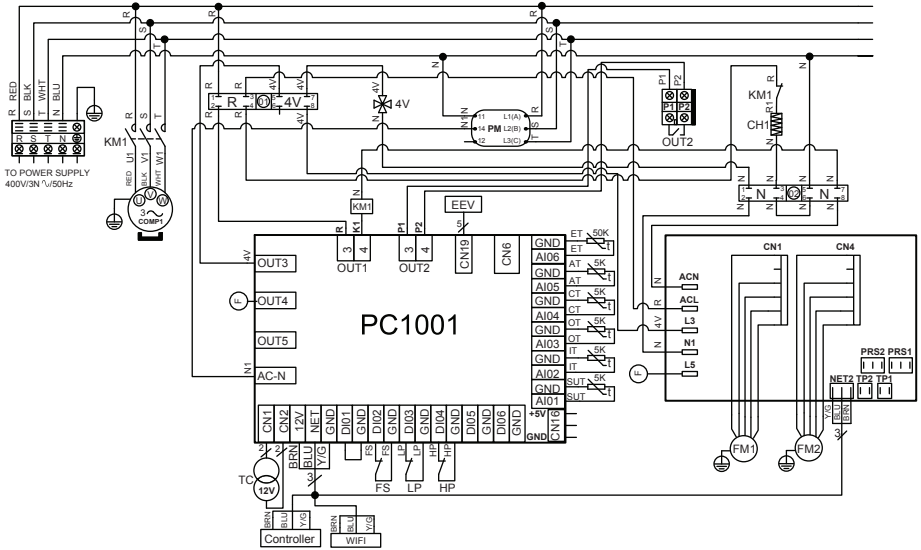

**OBSERVACIONES:**

- 1. AT : SONDA DE TEMPERATURA DE AIRE
- 2. COMP : COMPRESOR
- 3. CT : SONDA DE TEMPERATURA EVAPORADOR
- 4. EEV : DESCOMPRESOR ELECTRONICO
- 5. FM1-2 : MOTOR VENTILADOR
- 6. FS : DETECTOR DE PRESENCIA DE AGUA
- 7. HP : PRESOSTATO ALTA PRESION
- 8. IT : SONDA DE TEMPERATURA DE ENTRADA DE AGUA
- 9. LP : PRESOSTATO BAJA PRESION

- 10. OT : SONDA DE TEMPERATURA DE ENTRADA DE AGUA
- 11. SUT : SONDA DE TEMPERATURA DE ASPIRACION
- 12. TC : TRANSFORMADOR 230V~/ 12V~
- 13. 4V : VALVULA 4 VIAS
- 14. KM1 : CONTACTOR DE POTENCIA
- 15. PM : CONTROLADOR DE FASE
- 16. CH1 : RESISTENCIA CARTER
- 17. OUT2 : CONTACTO SECO LIBRE DE 7 A MÁX. DE POTENCIAL
- 18. ET : SONDA DE TEMPERATURA DE DESCARGA

## 6. ANEXOS (continuación)

### 6.2 Conexiones con prioridad al calentador de bomba monofásico

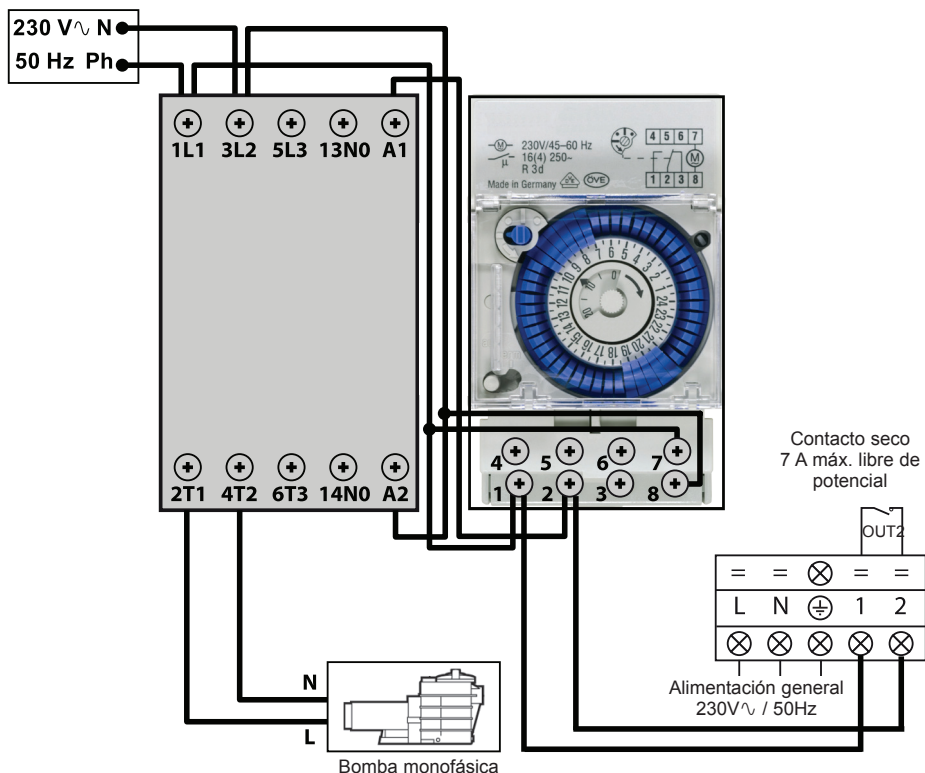

Los bornes 1 et 2 suministran un contacto seco (libre de potencial), sin polaridad de 230 V  $\sim$  / 50 Hz.

Conecte los cables a los bornes 1 y 2 respetando el esquema de cableado que se indica a continuación para que la bomba de filtración funcione por ciclos de 2 min cada hora en caso de que la temperatura de la piscina sea inferior al punto de consigna.

 No conecte nunca la alimentación de la bomba de filtración directamente a los bornes 1 y 2.



## 6. ANEXOS (continuación)

### 6.2 Conexiones con prioridad al calentador de bomba trifásico

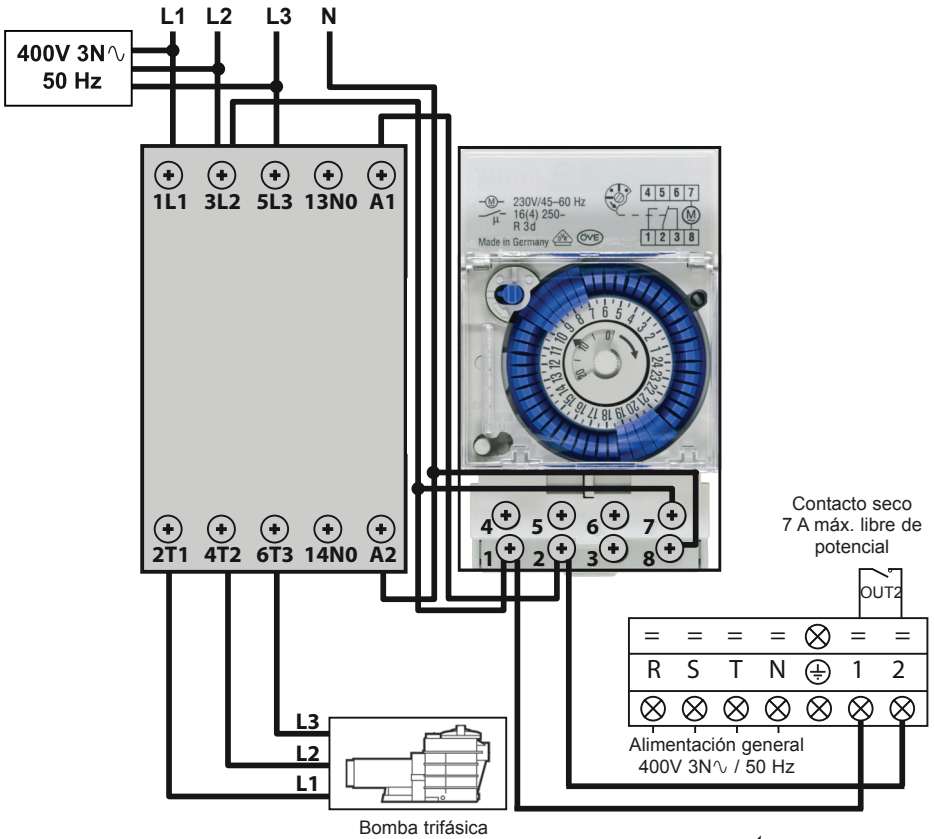

Los bornes 1 y 2 suministran un contacto seco (libre de potencial), sin polaridad de 230 V~ / 50 Hz.

Conecte los cables a los bornes 1 y 2 respetando el esquema de cableado que se indica a continuación para que la bomba de filtración funcione por ciclos de 2 min cada hora en caso de que la temperatura de la piscina sea inferior al punto de consigna.

⚠ No conecte nunca la alimentación de la bomba de filtración directamente a los bornes 1 y 2.



## 6. ANEXOS (continuación)

### 6.3 Despiece y piezas de recambio

#### ENP6MASC

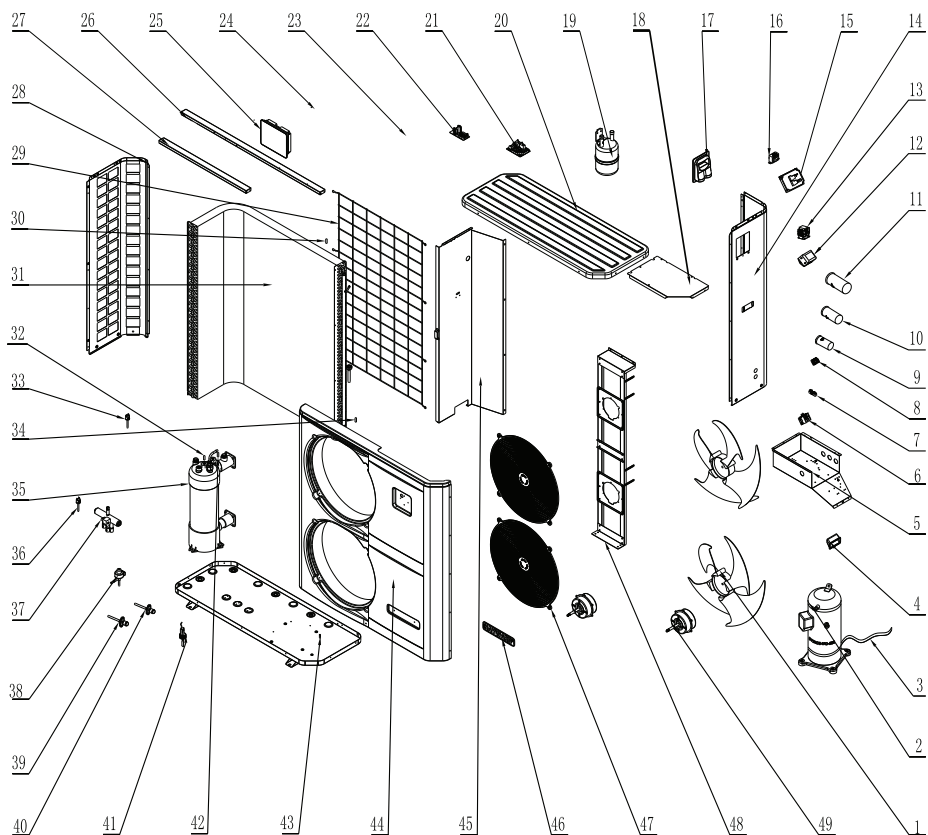

## 6. ANEXOS (continuación)

### ENP6MASC

Rep	Ref.	Designación	Rep	Ref.	Designación
1	HWX20000270004	Hélice ventilador	28	HWX32019210028	Panel izquierdo
2	HWX200011112	Compressore	29	HWX32019210031	Protección evaporador
3	HWX20003214	Resistencia del cárter	30	HWX20003242	Sonda de temperatura de aire
4	HWX32008220037	Empuñadura	31	HWX32010120008	Evaporador
5	HWX32019210040	Armario eléctrico	32	HWX20003242	Sonda de entrada de agua
6	HWX20003920	Borna de 3 conexiones	33	HWX20013605	Presostato de alta presión
7	HWX20003909	Borna de 3 conexiones	34	HWX20003242	Sonda de temperatura evaporador
8	HWX20003933	Borna de 3 conexiones	35	HWX32010120023	Condensador de titanio PVC
9	HWX20003504	Condensador compresor (35 $\mu$ F)	36	HWX20003603	Presostato baja presión
10	HWX20003510	Condensador compresor (60 $\mu$ F)	37	HWX20011491	Válvula 4 vías
11	HWX20000350011	Condensador de arranque (193 $\mu$ F)	38	HWX20000140346	Descompresor electrónico
12	HWX20003254	Filtro CEM	39	HWX20000140353	Toma de presión AP&BP
13	HWX200036007	Contactador Compresor mono	40	HWX20000140353	Toma de presión AP&BP
14	HWX32010210013	Panel derecho	41	HWX200036005	Detector del caudal de agua
15	HWX20003151	Arrancador electrónico	42	HWX20003242	Sonda de salida de agua
16	HWX200037003	Transformador 230V $\sim$ / 12V $\sim$	43	HWX32019210061	Fondo
17	HWX32009220032	Trampilla de acceso eléctrico	44	HWX32019210049	Panel delantero
18	HWX32019210025	Panel de protección eléctrica	45	HWX32019210026	Panel de separación
19	HWX20001440	Depósito de líquido	46	HWX20000230596	Logo Hayward
20	HWX32019220001	Panel superior	47	HWX20000220169	Rejilla de protección del ventilador
21	HWX95053114512E	Tarjeta electrónica	48	HWX32019210022	Soporte Motor
22	HWX950531024103	Módulo convertidor de CC	49	HWX20000330132	Motor de CC
*23*	HWX20003223	Sonda Compresor 50k $\Omega$	*50*	HWX20002625	Silentblock
24	/	/	*51*	HWX200026009	Junta tórica ID 43-Ep 3,4 mm
25	HWX95005010018	Regulador LED	*52*	HWX200026061	Junta tórica ID 48-Ep 5 mm
26	HWX32019210030	Rigidizador pequeño	*53*	HWX20000240112	Cubierta de protección
27	HWX32019210029	Rigidizador pequeño	*54*	HWX20001345	Tapón de vaciado

## 6. ANEXOS (continuación)

ENP6TASC

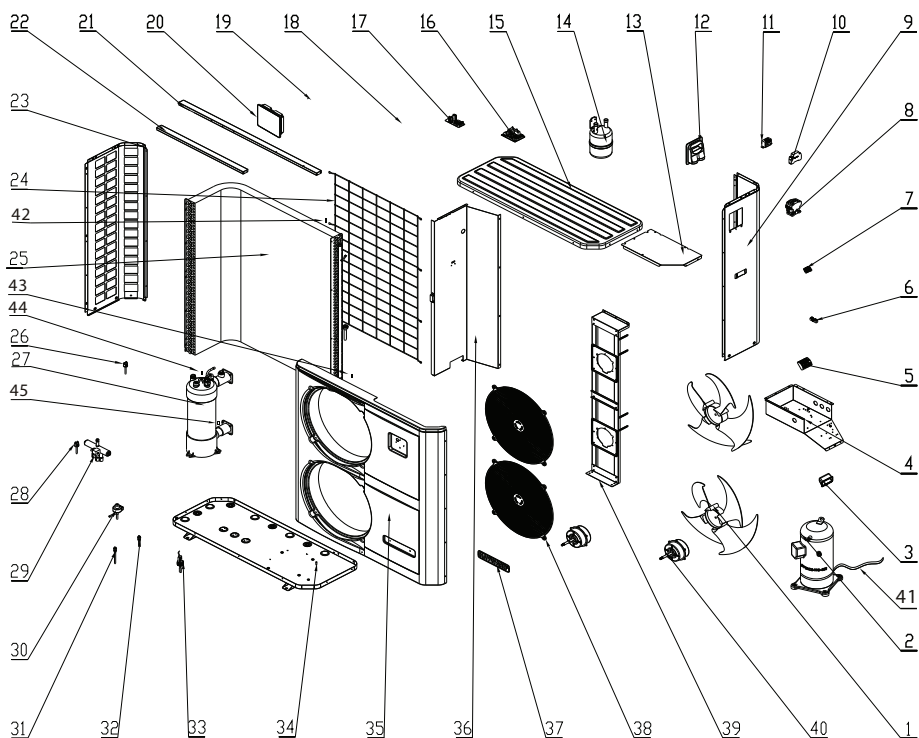



## 6. ANEXOS (continuación)

### ENP6TASC

Rep	Ref.	Designación	Rep	Ref.	Designación
1	HWX20000270004	Hélice ventilador	26	HWX20013605	Presostato de alta presión
2	HWX20000110146	Compresor	27	HWX32019120007	Condensador de titanio PVC
3	HWX32008220037	Empuñadura	28	HWX20003603	Presostato baja presión
4	HWX32019210024	Armario eléctrico	29	HWX20011491	Válvula 4 vías
5	HWX20003902	Borna de 5 conexiones tri	30	HWX20000140346	Descompresor electrónico
6	HWX20003909	Borna de 3 conexiones	31		
7	HWX20003933	Borna de 3 conexiones	32		
8	HWX20003653	Contactora Compresor TRI	33	HWX200036005	Detector del caudal de agua
9	HWX32019210027	Panel derecho	34	HWX32019210061	Fondo
10	HWX200036023	Controlador de fase	35	HWX32019210049	Panel delantero
11	HWX200037003	Transformador 230V <sub>~</sub> / 12V <sub>~</sub>	36	HWX32019210026	Panel de separación
12	HWX32009220032	Trampilla de acceso eléctrico	37	HWX20000230596	Logo Hayward
13	HWX32019210025	Panel de protección eléctrica	38	HWX20000220169	Rejilla de protección del ventilador
14	HWX20001440	Depósito de líquido	39	HWX32019210022	Soporte Motor
15	HWX32019220001	Panel superior	40	HWX20000330132	Motor de CC
16	HWX95053114510E	Tarjeta electrónica	41	HWX20003214	Resistencia del cárter
17	HWX950531024101	Módulo convertidor de CC	42	HWX20003242	Sonda de temperatura de aire
*18*	HWX20003223	Sonda Compresor 50k $\Omega$	43		Sonda de temperatura de evaporador
19	/	/	44		Sonda de entrada de agua
20	HWX95005010018	Regulador LED	45		Sonda de salida de agua
21	HWX32019210030	Rigidizador grande	*46*	HWX20002625	Silentblock
22	HWX32019210029	Rigidizador pequeño	*47*	HWX200026009	Junta tórica ID 48-Ep 5 mm
23	HWX32019210028	Panel izquierdo	*48*	HWX200026061	Junta tórica ID 43-Ep 3,4 mm
24	HWX32019210031	Protección evaporador	*49*	HWX20000240112	Cubierta de protección
25	HWX32010120008	Evaporador	*50*	HWX20001345	Tapón de vaciado

Nota: Las marcas \*xx\* no están referenciadas en la vista detallada correspondiente.

## 6. ANEXOS (continuación)

ENP7TASC

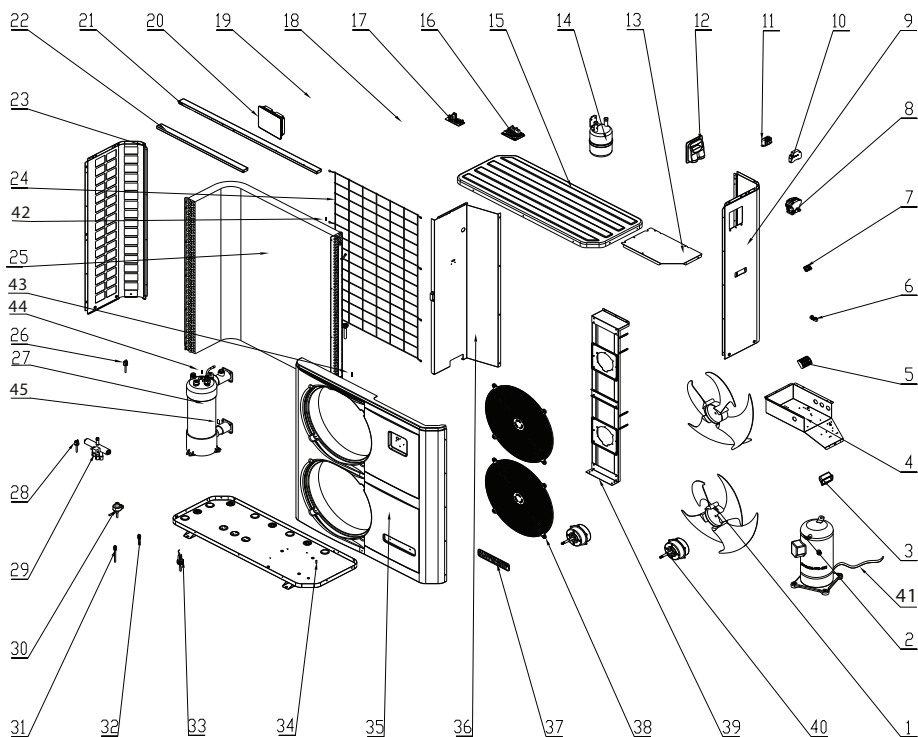

## 6. ANEXOS (continuación)

### ENP7TASC

Rep	Ref.	Designación	Rep	Ref.	Designación
1	HWX20000270004	Hélice ventilador	26	HWX20013605	Presostato de alta presión
2	HWX20000110138	Compresor	27	HWX32019120007	Condensador de titanio PVC
3	HWX32008220037	Empuñadura	28	HWX20003603	Presostato baja presión
4	HWX32019210024	Armario eléctrico	29	HWX20011491	Válvula 4 vías
5	HWX20003902	Borna de 5 conexiones tri	30	HWX20000140398	Descompresor electrónico
6	HWX20003909	Borna de 2 conexiones	31		
7	HWX20003933	Borna de 3 conexiones	32		
8	HWX20003653	Contactador Compresor TRI	33	HWX200036005	Detector del caudal de agua
9	HWX32019210027	Panel derecho	34	HWX32019210061	Fondo
10	HWX200036023	Controlador de fase	35	HWX32019210049	Panel delantero
11	HWX200037003	Transformador 230V $\surd$ / 12V $\surd$	36	HWX32019210026	Panel de separación
12	HWX32009220032	Trampilla de acceso eléctrico	37	HWX20000230596	Logo Hayward
13	HWX32019210025	Panel de protección eléctrica	38	HWX20000220169	Rejilla de protección del ventilador
14	HWX20001440	Depósito de líquido	39	HWX32019210022	Soporte Motor
15	HWX32019220001	Panel superior	40	HWX20000330132	Motor de CC
16	HWX95053114511E	Tarjeta electrónica	41	HWX20003214	Resistencia del cárter
17	HWX950531024102	Módulo convertidor de CC	42	HWX20003242	Sonda de temperatura de aire
*18*	HWX20003223	Sonda Compresor 50k $\Omega$	43		Sonda de temperatura evaporador
19	/	/	44		Sonda de entrada de agua
20	HWX95005010018	Regulador LED	45		Sonda de salida de agua
21	HWX32019210030	Rigidizador pequeño	*46*	HWX20002625	Silentblock
22	HWX32019210029	Raidisseur Petit	*47*	HWX200026009	Junta tórica ID 48-Ep 5 mm
23	HWX32019210028	Panel izquierdo	*48*	HWX200026061	Junta tórica ID 43-Ep 3,4 mm
24	HWX32019210031	Protección evaporador	*49*	HWX20000240112	Cubierta de protección
25	HWX32019120002	Evaporador	*50*	HWX20001345	Tapón de vaciado

Nota: Las marcas \*xx\* no están referenciadas en la vista detallada correspondiente.

## 6. ANEXOS (continuación)

---



### 6.4 Guía de reparación

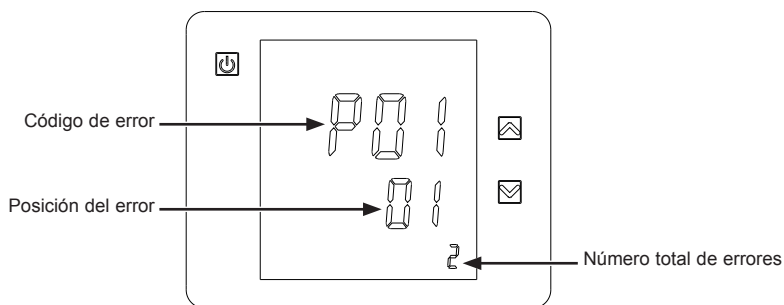

**Algunas operaciones deben ser realizadas por un técnico habilitado..**

En caso de fallo, las indicaciones siguientes aparecen en la pantalla:



En caso de errores múltiples, pulse  o  para hacer desfilar los códigos de error. Consulte la tabla siguiente.

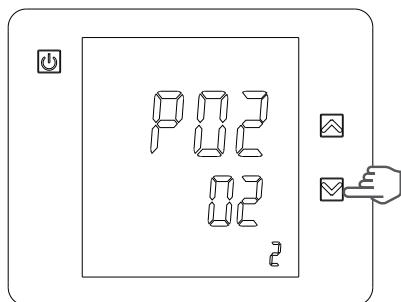

Fallo	Códigos de error	Descripción	Solución
Fallo de la sonda de entrada de agua	P01	El sensor está abierto o presenta un cortocircuito.	Comprobar o reemplazar el sensor.
Fallo de la sonda de salida de agua	P02	El sensor está abierto o presenta un cortocircuito.	Comprobar o reemplazar el sensor.
Fallo de la sonda de descongelación	P05	El sensor está abierto o presenta un cortocircuito.	Comprobar o reemplazar el sensor.
Fallo de la sonda de temperatura exterior	P04	El sensor está abierto o presenta un cortocircuito.	Comprobar o reemplazar el sensor.
Fallo de la sonda de aspiración del compresor	P07	El sensor está abierto o presenta un cortocircuito.	Comprobar o reemplazar el sensor.
Diferencia de temperatura demasiado grande entre el agua de salida y el agua de entrada	E06	Caudal de agua con un volumen insuficiente, diferencia de presión de agua demasiado débil/ demasiado elevada.	Comprobar el caudal de agua o la obstrucción del sistema.
Protección anticongelante Modo frío	E07	Cantidad de agua saliente demasiado débil.	Comprobar el caudal de agua o el sensor de temperatura de agua saliente.
Protección anticongelante de nivel 1	E19	Temperatura ambiente o del agua entrante demasiado débil.	
Protección anticongelante de nivel 2	E29	Temperatura ambiente o del agua entrante todavía más débil.	
Protección alta presión	E01	Presión del circuito frigorífico demasiado elevada, o el caudal de agua es demasiado débil, o el evaporador está obstruido, o el caudal de aire es demasiado débil.	Comprobar el presostato de alta presión y la presión del circuito frigorífico. Comprobar el caudal de agua o de aire. Comprobar el buen funcionamiento del controlador de caudal. Comprobar la apertura de las válvulas de entrada/salida de agua. Comprobar el ajuste del by-pass.
Protección baja presión	E02	Presión del circuito frigorífico demasiado débil, o el caudal de aire es demasiado débil o el evaporador está obstruido.	Comprobar el presostato de baja presión y la presión del circuito frigorífico para valorar si existe una fuga. Limpiar la superficie del evaporador. Comprobar la velocidad de rotación del ventilador. Comprobar la libre circulación del aire a través del evaporador.
Fallo del detector de caudal	E03	Caudal de agua insuficiente o detector en cortocircuito o defectuoso.	Comprobar el caudal de agua, el sistema de filtrado y el detector de caudal para ver si presentan otros fallos.
Problema de comunicación	E08	Fallo del controlador LED o de la conexión PCB.	Compruebe la conexión de los cables NET y NET 1.
El compresor no arranca	E08	Falta una fase u orden de las fases incorrectos	Compruebe la presencia de las 3 fases modifique el orden de las fases en la caja de bornes de la conexión eléctrica de la bomba de calor

## 6. ANEXOS (continuación)

---

### 6.5 Garantía

#### CONDICIONES DE GARANTIA

Todos los productos HAYWARD están garantizados contra todo vicio de construcción o de material durante un período de dos años a partir de la fecha de compra. Toda petición de garantía deberá acompañarse con la prueba de compra justificando la fecha de la misma. Aconsejamos conservar siempre su factura.

Nuestra garantía queda limitada al reemplazo sin cargo de las piezas defectuosas, con la condición que los equipos hayan sido empleados normalmente, y de acuerdo con las instrucciones mencionadas en su manual de utilización, la garantía no cubre los productos que después de la expedición han sido manipulados, modificados o empleados para otros usos, o bajo otros modos de empleo, diferentes a los que recomendamos. Los perjuicios ocasionados por las condiciones climatológicas o las producidas por agentes químicos están exentos de garantía. Todo gasto de transporte, mano de obra, están excluidos de la garantía. HAYWARD no será responsable bajo ningún concepto de perjuicios directos e indirectos causados por el funcionamiento incorrecto de un producto o de sus accesorios.

Para poder cubrir una garantía y pedir la reparación o la sustitución de un artículo, ponerse en contacto con su vendedor habitual. No se podrá enviar ningún material a nuestros almacenes sin previo acuerdo por escrito.

Las piezas de repuesto no están cubiertas pro la garantía.

ISENPASC Rev C

# ***ENERGYLINE PRO***

**BOMBA DE AQUECIMENTO PARA PISCINAS**



**Manual de instalação e de instruções**

# RESUMO

---

<b>1. Prefácio</b>	<b>1</b>
<hr/>	
<b>2. Características técnicas</b>	<b>2</b>
2.1 Dados técnicos da bomba de aquecimento	2
2.2 Período de funcionamento	3
2.3 Dimensões	4
<hr/>	
<b>3. Instalação e ligação</b>	<b>5</b>
3.1 Esquema de princípio	5
3.2 Bomba de aquecimento	6
3.3 Ligação hidráulica	6
3.4 Ligação eléctrica	7
3.5 Primeira colocação em funcionamento	8
3.6 Ajuste do débito de água	10
<hr/>	
<b>4. Interface do utilizador</b>	<b>11</b>
4.1 Apresentação geral	11
4.2 Ajuste do relógio	13
4.3 Ajuste da função timer (temporizador)	13
4.4 Escolha do modo de funcionamento	14
4.5 Ajuste e visualização do ponto de ajuste	15
4.6 Bloqueio e libertação do ecrã táctil	15
4.7 Ajustamento do modo silêncio	16
<hr/>	
<b>5. Manutenção e Preparação para o Inverno</b>	<b>19</b>
5.1 Manutenção	19
5.2 Preparação para o Inverno	19
<hr/>	
<b>6. Anexos</b>	<b>20</b>
6.1 Esquemas eléctricos	20
6.2 Ligações prioridade aquecimento	22
6.3 Vistas explodidas e peças sobressalentes	24
6.4 Guia de resolução de avarias	30
6.5 Garantia	32

Ler atentamente e conservar para consulta posterior.

Este documento deve ser entregue ao proprietário da piscina e deve ser conservado por este em local seguro.



# 1. PREFÁCIO

---

Estamos gratos por ter adquirido esta bomba de aquecimento para piscina da Hayward. Este produto foi concebido segundo normas de fabrico exigentes para cumprir os níveis de qualidade requeridos. O presente manual inclui todas as informações necessárias relativas à instalação, eliminação de avarias e manutenção. Leia atentamente este manual antes de abrir a unidade ou realizar operações de manutenção na mesma. O fabricante deste produto não será em nenhum caso responsável no caso de lesão do utilizador ou de danos na unidade na sequência de eventuais erros durante a instalação, a eliminação de avarias ou uma manutenção inútil. É essencial seguir sempre as instruções especificadas neste manual. A unidade deve ser instalada por pessoal qualificado.

- As reparações devem ser efectuadas por pessoal qualificado.
- Todas as ligações eléctricas devem ser efectuadas por um electricista profissional qualificado e segundo as normas em vigor no país de instalação cf § 3.4.
- A manutenção e as diferentes operações devem ser realizadas com a frequência e nos momentos recomendados, como especificado no presente manual.
- Utilize apenas peças sobressalentes de origem.
- Qualquer recomendação não cumprida anula a garantia.
- Esta bomba de aquecimento aquece a água da piscina e mantém uma temperatura constante, e não deve ser utilizada para outros fins.

Depois de ter lido este manual, guarde-o para utilização posterior.

Avisos relativos a crianças / pessoas com capacidade física reduzida:

Este equipamento não se destina a ser utilizado por pessoas (nomeadamente crianças) cujas capacidades físicas, sensoriais ou intelectuais são reduzidas, ou por pessoas sem experiência ou conhecimento, a menos que se encontrem sob vigilância ou tenham recebido instruções quanto à utilização do equipamento por parte da pessoa responsável pela sua segurança.

Este produto contém gases com efeito de estufa fluorados que estão enquadrados pelo protocolo de Quioto.

Tipo de refrigerante: R410A

Valor GWP<sup>(1)</sup>: 1975

Podem ser requeridas inspecções periódicas em função da legislação europeia ou local. Queira contactar o seu distribuidor local para mais informações.

---

(1) Potencial de aquecimento global

## 2. CARACTERÍSTICAS TÉCNICAS

---

### 2.1 Dados técnicos da bomba de aquecimento

Modelos	ENERGYLINE PRO	ENP6MASC	ENP6TASC	ENP7TASC
Capacidad calorífica *	kW	17,8	18,2	23,4
Potencia eléctrica absorbida *	kW	3,69	3,7	5,15
Corriente de funcionamiento *	A	16,2	7,69 / 6,89 / 6,33	9,71 / 8,01 / 7,70
Tensión de alimentación	V Ph/Hz	230V∨ 50Hz	400V 3N∨ 50Hz	400V 3N∨ 50Hz
Calibre de fusible tipo aM	A	20	12	16
Disyuntor curva D	A	20	12	16
Número de compresores		1	1	1
Tipo de compresor		Scroll	Scroll	Scroll
Número de ventiladores		2	2	2
Potencia del ventilador	W	50 — 225	50 — 225	50 — 225
Velocidad de rotación de los ventiladores	RPM	600 — 950	830 — 960	800 — 1050
Ventilación		Horizontal	Horizontal	Horizontal
Nivel de presión acústica (a 1 metro)	dB(A)	45	45	47
Conexión hidráulica	mm	50	50	50
Caudal nominal de agua*	m <sup>3</sup> /h	6,6	6,6	8
Pérdida de carga sobre el agua (max)	kPa	7	7	18
Dimensiones netas de la unidad (L/a/a)	mm	1138 / 470 / 1264	1138 / 470 / 1264	1138 / 470 / 1264
Peso neto de la unidad	kg	127	123	140



\* Valor a +/- 5% nas condições seguintes: Temperatura exterior = 15°C (59°F) / HR = 71% /  
Temperatura de entrada de água = 26°C (78,8°F)  
Em conformidade com o referencial NF -414 (utilização anual)

## 2. CARACTERÍSTICAS TÉCNICAS (continuação)

---

### 2.2 Período de funcionamento

Utilizar a bomba de aquecimento nos seguintes intervalos de temperatura e humidade para assegurar um funcionamento seguro e eficaz.

	Modo de aquecimento 	Modo de Refrigeração 
Temperatura exterior	-12°C ~ +35°C	+7°C ~ +43°C
Temperatura da água	+12°C ~ +40°C	+8°C ~ +40°C
Humidade relativa	< 80%	< 80%
Intervalo de Ajuste do ponto de afinação	+15°C ~ +32°C	+8°C ~ +32°C



***Se a temperatura e a humidade não corresponderem a estas condições, podem disparar os dispositivos de segurança e a bomba de aquecimento pode deixar de funcionar.***



***A temperatura máxima de aquecimento é limitada à 32°C a fim de evitar a deterioração dos liners. Hayward declina qualquer responsabilidades em caso de utilização que ultrapassa os +32°C.***

## 2. CARACTERÍSTICAS TÉCNICAS (continuação)

### 2.3 Dimensões

Modelos: ENP6MASC / ENP6TASC / ENP7TASC

Unidade: mm

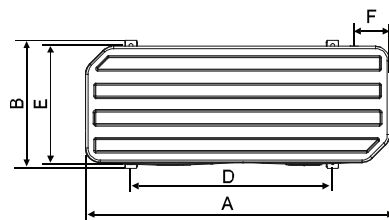
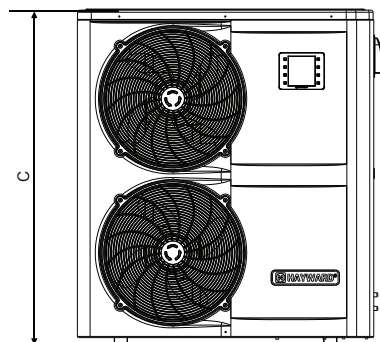
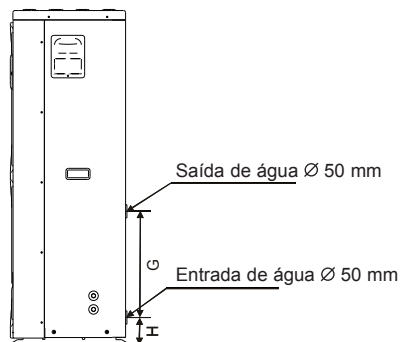

TIPO (mm)	ENP6MASC	ENP6TASC ENP7TASC
A	1138	1138
B	470	470
C	1264	1264
D	790	790
E	447	447
F	114	114
G	500	400
H	104	104

### 3. INSTALAÇÃO E LIGAÇÃO

#### 3.1 Esquema de princípio

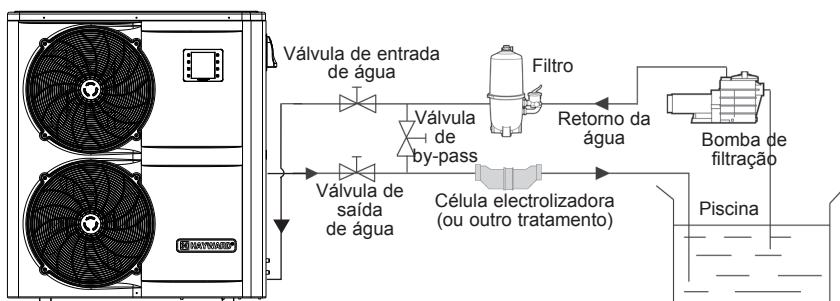

Nota: A bomba de aquecimento é fornecida sem qualquer equipamento de tratamento ou filtração. Os elementos presentes no esquema são peças a fornecer pelo instalador.

#### 3.2 Bomba de aquecimento



**Colocar a bomba de aquecimento no exterior e fora de qualquer local técnico fechado.**

**Colocada sob abrigo, devem ser respeitadas as distâncias mínimas prescritas abaixo a fim de evitar qualquer risco de recirculação de ar e de degradação dos desempenhos globais da bomba de aquecimento.**

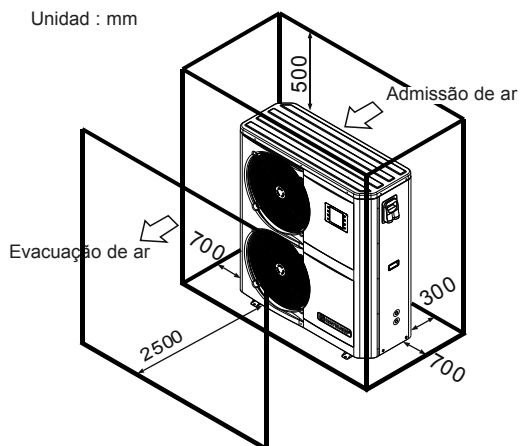

### 3. INSTALAÇÃO E LIGAÇÃO (continuação)

---



**Instalar de preferência a bomba de calor sobre uma laje de betão dessolidarizada ou uma caixa de fixação prevista para este efeito e montar a bomba de aquecimento sobre os blocos amortecedores fornecidos (parafusos e anilhas não fornecidos).**

**Distância máxima de instalação entre a bomba de aquecimento e a piscina 15 metros.**

**Comprimento total ida e volta das canalizações hidráulicas 30 metros.**

**Isolar as canalizações hidráulicas de superfície e enterradas.**

#### 3.3 Ligação hidráulica

A bomba de aquecimento é fornecida com duas uniões de 50 mm de diâmetro. Utilizar tubo PVC para canalização hidráulica Ø 50 mm. Ligar a entrada de água da bomba de aquecimento à conduta proveniente do grupo de filtração e, em seguida, ligar a saída de água da bomba de aquecimento à conduta de água que segue para a bacia (consultar esquema abaixo).

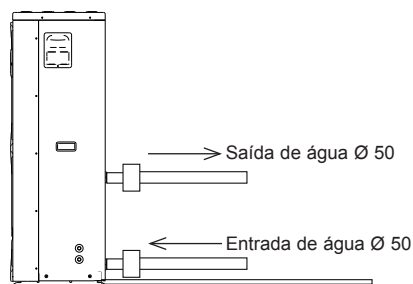

Instalar uma válvula dita de “by-pass” entre a entrada e a saída da bomba de aquecimento.



**Se for utilizado um distribuidor automático, deve obrigatoriamente ser instalado após a bomba de aquecimento a fim de proteger o condensador Titane contra uma concentração demasiado elevada de produto químico.**



**Tenha o cuidado de instalar a bomba de by-pass e as uniões fornecidas ao nível de entrada e saída de água da unidade, a fim de simplificar a purga durante o período de Inverno, facilitar o acesso ou a respectiva desmontagem para manutenção.**

### 3. INSTALAÇÃO E LIGAÇÃO (continuação)

#### 3.4 Ligação eléctrica



**A instalação eléctrica e a cablagem deste equipamento devem estar em conformidade com a regras de instalação locais em vigor.**

F	NF C15-100	GB	BS7671:1992
D	DIN VDE 0100-702	EW	EVHS-HD 384-7-702
A	ÖVE 8001-4-702	H	MSZ 2364-702/1994/MSZ 10-553 1/1990
E	UNE 20460-7-702 1993, RECBT ITC-BT-31 2002	M	MSA HD 384-7-702.S2
IRL	Regras de cablagem + IS HD 384-7-702	PL	PN-IEC 60364-7-702:1999
I	CEI 64-8/7	CZ	CSN 33 2000 7-702
LUX	384-7.702 S2	SK	STN 33 2000-7-702
NL	NEN 1010-7-702	SLO	SIST HD 384-7-702.S2
P	RSIUEE	TR	TS IEC 60364-7-702



**Verifique que a alimentação eléctrica disponível e a frequência da rede correspondem à corrente de funcionamento requerida, tendo em conta a localização específica do equipamento, e a corrente necessária para alimentar qualquer outro aparelho ligado ao mesmo circuito.**

**ENP6MASC 230 V $\sim$  +/- 10 % 50 Hz 1 Phase**

**ENP6TASC 400 V $\sim$  +/- 10 % 50 Hz 3 Phases**

**ENP7TASC 400 V $\sim$  +/- 10 % 50 Hz 3 Phases**



**Verificar que o equilíbrio das fases não excede os 2%**

**Observe o esquema de cablagem correspondente em anexo.**

**A caixa de ligações encontra-se do lado direito da unidade. Três ligações destinam-se à alimentação eléctrica, e duas ao comando da bomba de filtração (Servocomando).**

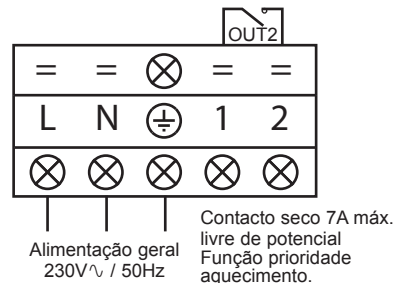
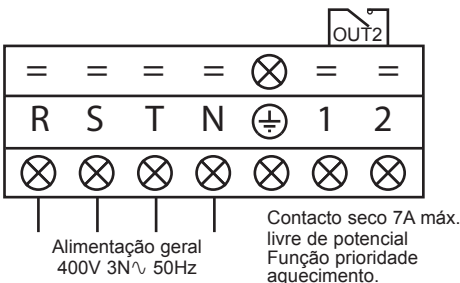

### 3. INSTALAÇÃO E LIGAÇÃO (continuação)



**A linha de alimentação eléctrica deve ser dotada, de maneira apropriada, de um dispositivo de protecção fusível do tipo alimentação de motor (aM) ou disjuntor curvo D bem como de um disjuntor diferencial de 30mA (ver tabela anexa).**

Modelos		ENP6MASC	ENP6TASC	ENP7TASC
Alimentação eléctrica	V/Ph/Hz	230V~ 50Hz	400V 3N~ 50Hz	400V 3N~ 50Hz
Calibre fusível tipo aM	A	20 aM	12 aM	16 aM
Disjuntor curvo D	A	20 D	12 D	16 D
Secção de cabo	mm <sup>2</sup>	3G6 3 x 6	5G2,5 5 x 2,5	5G2,5 5 x 2,5



**Utilizar o cabo de alimentação do tipo RO 2V / R 2V ou equivalente.**



**As secções de cabo são fornecidas para um comprimento máximo de 25 m. Devem no entanto ser verificadas e adaptadas em função das condições de instalação.**



**Tenha sempre o cuidado de interromper a alimentação principal antes de abrir a caixa de comando eléctrico.**

#### 3.5 Primeira colocação em serviço

Procedimento de arranque - uma vez a instalação terminada, seguir e respeitar as etapas seguintes:

- 1) Faça girar os ventiladores com a mão a fim de verificar que ele pode girar livremente com a mão, e que a hélice está fixada correctamente sobre o eixo do motor.
- 2) Assegure-se que a unidade está correctamente ligada à alimentação principal (ver esquema de cablagem em anexo).
- 3) Active a bomba de filtração.
- 4) Verifique que todas as válvulas de água estão abertas, e que a água flui para a unidade antes de passar ao modo de aquecimento ou refrigeração.
- 5) Verifique que o tubo de purga de condensados está correctamente fixado e não apresenta nenhuma obstrução.
- 6) Active a alimentação eléctrica destinada à unidade, depois prima a tecla Marche/Arrêt (Marcha/Paragem)  no painel de comando.



### 3. INSTALAÇÃO E LIGAÇÃO (continuação)

- 7) Verifique que não aparece nenhum código de ALARME quando a unidade está ON (Ligado) (ver guia de resolução de avarias).
- 8) Fixe o débito de água com a ajuda da válvula de by-pass (ver § 3.6 e 2.1), conforme previsto respectivamente para cada modelo, de modo a obter uma diferença de temperatura Entrada/Sáida de 2°C.
- 9) Após um funcionamento de alguns minutos, verifique que o ar que sai da unidade é refrigerado (entre 5 e 10°).
- 10) Com a unidade em serviço, desactive a bomba de filtração. A unidade deve parar automaticamente e apresentar o código de erro E03.
- 11) Faça funcionar a unidade e a bomba da piscina 24 horas sobre 24, até que seja atingida a temperatura da água pretendida. Quando a temperatura de entrada de água atingir o valor de afinação, a unidade pára. Volta então a arrancar automaticamente (desde que a bomba da piscina esteja em serviço) se a temperatura da piscina for inferior em pelo menos 0,5°C à temperatura regulada.

**Controlador de débito** - A unidade é dotada de um controlador de débito que activa a bomba de calor quando a bomba de filtração da piscina está em serviço, e desactiva-a quando a bomba de filtração está fora de serviço. Por falta de água, aparece no regulador o código de alarme E03 (Ver § 6.4).

**Temporização** - a unidade integra uma temporização de 3 minutos, a fim de proteger os componentes do circuito de comando, eliminar qualquer instabilidade em termos de re-arranque e qualquer interferência ao nível do contactor. Graças a esta temporização, a unidade voltar a arrancar automaticamente cerca de 3 minutos após qualquer corte do circuito de comando. Mesmo um corte de corrente de curta duração activa a temporização de arranque.

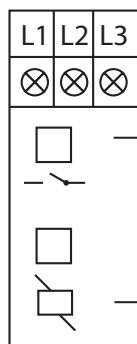

**Controlador de fase** - As unidades trifásicas integram um controlador de fase para garantir o bom sentido de rotação do compressor. Se a unidade não arrancar, verificar o estado do controlador de fase situado no armário eléctrico.

Amarelo/laranja ON = Relé ON = Ordem e número de fase OK

Verde = Sob tensão

### 3. INSTALAÇÃO E LIGAÇÃO (continuação)

---

#### 3.6 Ajuste do débito de água

Com as válvulas de entrada e saída de água abertas, ajustar a válvula de “by-pass” de modo a obter uma diferença de 2°C entre a temperatura de entrada e saída de água (ver esquema de princípio § 3.1). Pode verificar o Ajuste visualizando as temperaturas de entrada/saída directamente no painel de comando.

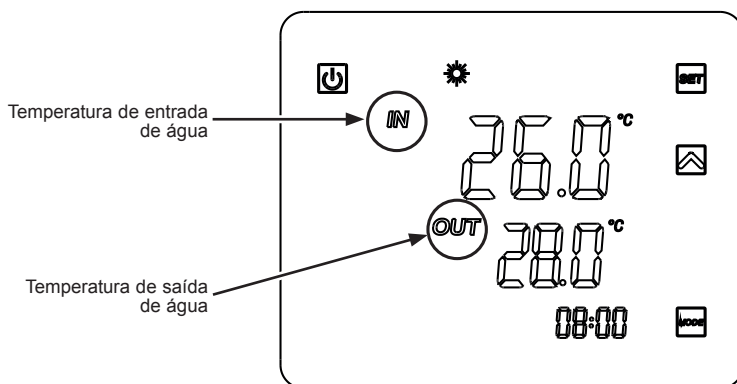

Nota: A abertura da válvula de “by-pass” provoca um débito menor, logo um aumento da  $\Delta T$ .

O fecho da válvula de “by-pass” provoca um débito maior, logo uma diminuição da  $\Delta T$ .

# 4. INTERFACE DO UTILIZADOR

## 4.1 Apresentação geral

A bomba de aquecimento está equipada com um painel de comando digital com ecrã táctil, ligado electricamente e pré-regulado de fábrica em modo de aquecimento.

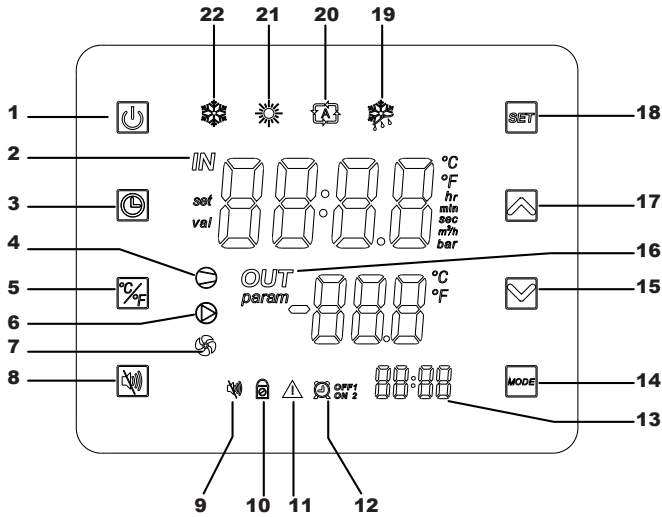

### Legenda

1		Marcha/Paragem	12		Timers 1 e 2 (temporizadores)
2	<i>IN</i>	Entrada de água	13		Hora dos Timers
3		Ajuste da hora e Timers	14		Seleção do modo
4		Compressor ON	15		Deslocamento para baixo/ Diminuir
5		Conversão °C/°F	16	<i>OUT</i>	Saída de água
6		Contacto seco OUT2	17		Deslocamento para cima/ Aumentar
7		Ventilador ON	18		Registar / Ajustar
8		Modo silêncio	19		Modo degelo
9		Indicador do modo silêncio	20		Modo automático
10		Ecrã bloqueado	21		Modo aquecimento
11		Alarme	22		Mode arrefecimento

## 4. INTERFACE DO UTILIZADOR (continuação)

### Modo OFF (desligado)

Quando a bomba de aquecimento está em espera (Modo OFF) aparece no ecrã do regulador a inscrição “OFF”.

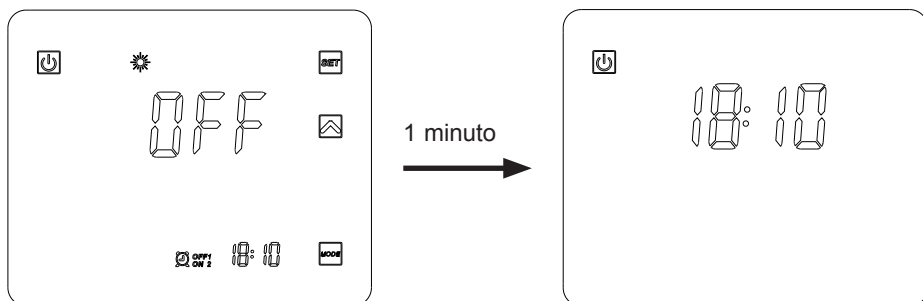

### Modo ON (ligado)

Quando a bomba de aquecimento está em funcionamento ou em Ajuste (Modo ON) as temperaturas de entrada e de saída de água são apresentadas no ecrã do regulador.

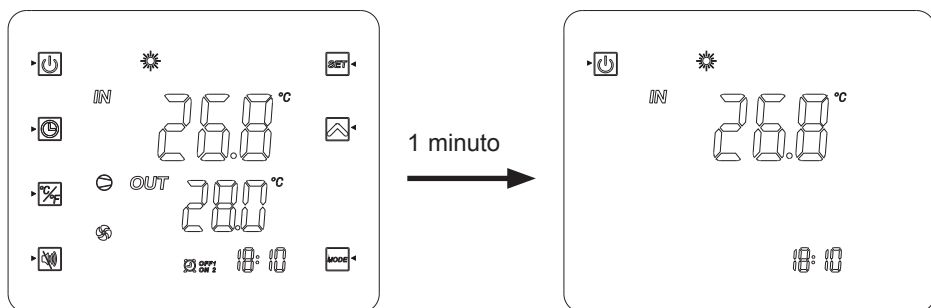











## 4. INTERFACE DO UTILIZADOR (continuação)

No final dos ajustes, pressione  para confirmar.

Os ajustes estão automaticamente registados após 20 anos sem ação.

### 4.2 Ajuste do relógio

Se o mostrador estiver em modo de espera, premir o botão  durante alguns segundos.









- 1) Premir  para que o símbolo  apareça.
- 2) Premir , a indicação da hora pisca. Ajustar as horas com os botões  .
- 3) Premir  e ajustar os minutos com os botões  .
- 4) Premir  para registar.

### 4.3 Ajuste da função Timer (temporizador)











O ajuste desta função é necessária caso pretenda fazer funcionar a bomba de aquecimento por um período mais curto que o definido pelo relógio de filtração. Pode assim programar um arranque diferido e um arranque antecipado ou simplesmente impedir um intervalo horário de funcionamento (por exemplo a noite).

É possível programar 2 Timers de Arranque (ON1 e ON2) e 2 Timers de Paragem (OFF1 e OFF2).

#### Programação do Timer 1 – Arranque

- 1) Premir  durante 2 seg., o Timer ON1  pisca (\*).
- 2) Premir  para ajustar as horas com os botões  .
- 3) Premir  para ajustar os minutos com os botões  .
- 4) Premir  para registar.



#### Programação do Timer 1 – Paragem

- 1) Premir  durante 2 seg., o Timer ON1  pisca (\*).  
Premir uma vez , o Timer OFF1  pisca.
- 2) Premir  para ajustar as horas com os botões  .
- 3) Premir  para ajustar os minutos com os botões  .
- 4) Premir  para registar.



(\*) Para aceder diretamente ao Timer ON2 , premir  durante 2 seg., pois premir 2 vezes .

## 4. INTERFACE DO UTILIZADOR (continuação)

















### Programação do Timer 2

Após os ajustes do Timer 1, é possível aceder diretamente aos ajustes do Timer 2 :  e .

Proceda da mesma maneira que para o Timer 1.

**Nota:** Para aceder diretamente ao Timer ON2 , premir  durante 2 seg., pois premir 2 vezes .

### Supressão dos Timers (Départ et Arrêt)

- 1) Premir  durante 2 seg., o Timer ON1  pisca (\*).
  - 2) Premir  a indicação da hora pisca.
  - 3) Premir  para cancelar o Timer .
  - 4) Premir  para validar.
  - 5) Premir  durante 2 seg., o Timer ON1  pisca.  
Premir uma vez , o Timer  pisca.(\*)
  - 6) Premir  a indicação da hora pisca.
  - 7) Premir  para cancelar o Timer .
- (\*) Para aceder aos Timers 2  ou , seguir as etapas 1)- 4), depois premir 2 vezes . Proceda da mesma maneira do que acima.

### 4.4 Escolha do modo de funcionamento: arrefecimento, aquecimento ou automático

#### Em Modo “OFF” ou “ON”

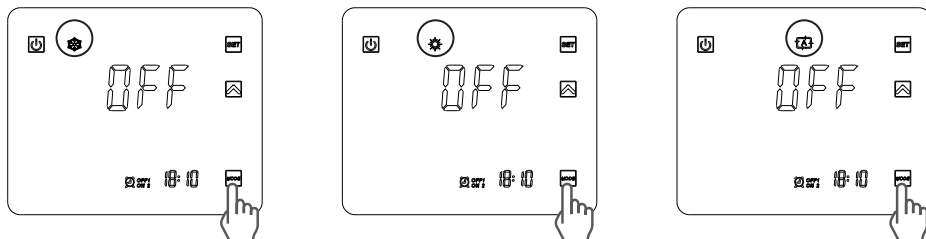

Premir  para mudar o modo: arrefecimento, aquecimento ou automático.



**Se a bomba de aquecimento é definida em apenas aquecimento ou arrefecimento modo só, a mudança do modo não é possível.**

## 4. INTERFACE DO UTILIZADOR (continuação)



### 4.5 Ajuste e visualização do ponto de ajuste (Temperatura da água pretendida)

Se o botão  não estiver visível no ecrã, premir brevemente .

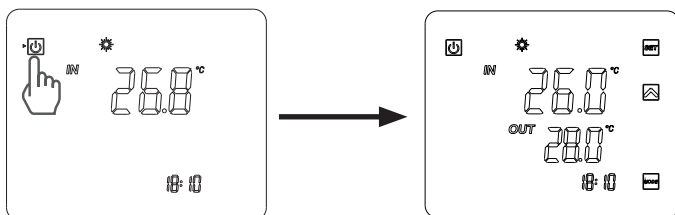
(Em funcionamento ou parado, basta premir o botão  para visualizar o ponto de ajuste.)



#### Em Modo “OFF” ou Modo “ON”



Premir  para visualizar o ponto de ajuste ; depois premir  ou  para definir o ponto de ajuste pretendido.



O ajuste efectua-se com uma precisão de 0,5 °C.



**É recomendável nunca ultrapassar a temperatura de 30°C para evitar a alteração das juntas.**

### 4.6 Bloqueio e libertação do ecrã táctil

Premir o botão  durante 5 seg. até a emissão de um bipe e o aparecimento do símbolo .

Para desbloquear, premir  durante 5 seg. até a emissão de um bipe e o desaparecimento do símbolo .

## 4. INTERFACE DO UTILIZADOR (continuação)

### 4.7 Ajustamento do modo SILÊNCIO (🔇)

Esta função permite a utilização da bomba de calor com uma velocidade de rotação dos ventiladores reduzida à 600Tr/min para o ENP6MASC, 830Tr/min para o ENP6TASC e 800 r/min para o ENP7TASC durante 8 horas no máximo, a fim de limitar os danos sonoros em período nocturno e/ou diurno de acordo com a localização da bomba de calor em relação à vizinhança e/ou a bacia.



Esta função pode ser Activada/Desactivada manualmente ou usando um temporizador.

#### Activação Manual

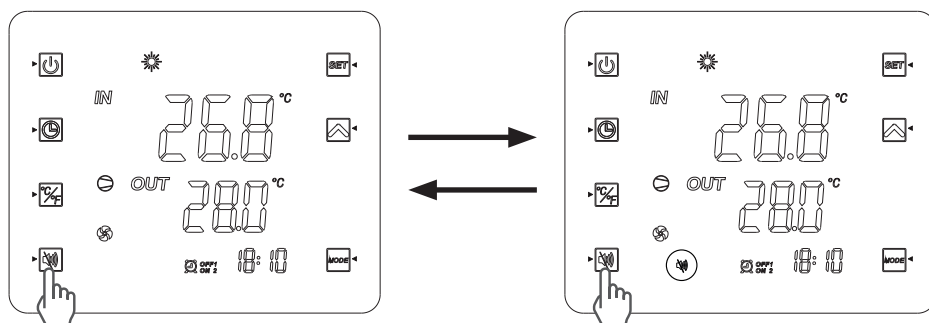
- 1) Premir o botão .
- 2) A indicação abaixo aparece no ecrã : o modo Silêncio está activado paras as 8 horas seguintes.
- 3) Os ventiladores reduzem progressivamente a velocidade de rotação para uma duração de 8 horas no máximo.
- 4) Após 8 horas de funcionamento a função será automaticamente desactivada e os ventiladores retomarão uma velocidade de rotação em função da temperatura do ar exterior.





#### Désactivation Manuelle

- 1) Premir o botão .
- 2) O indicador  desaparece do ecrã: o modo Silêncio está desactivado.
- 3) Os ventiladores ajustam a velocidade de rotação em função da temperatura exterior do ar.



## 4. INTERFACE DO UTILIZADOR (continuação)





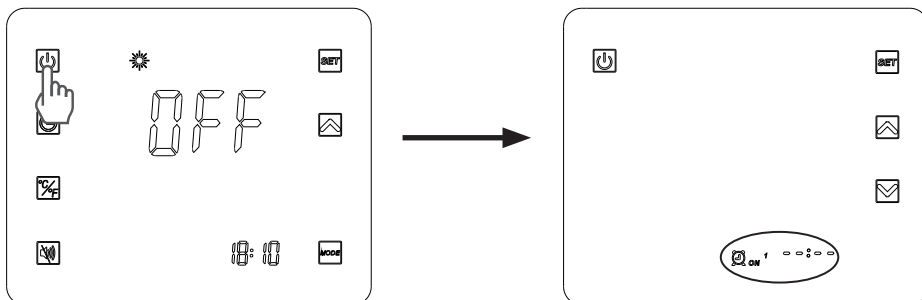

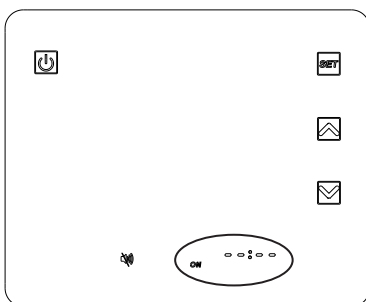

### Programação do modo SILÊNCIO

- 1) Premir  durante 2 seg., o Timer ON1  ON<sup>1</sup> pisca .



- 2) Premir 4 vezes  até aceder ao ecrã indicado abaixo.





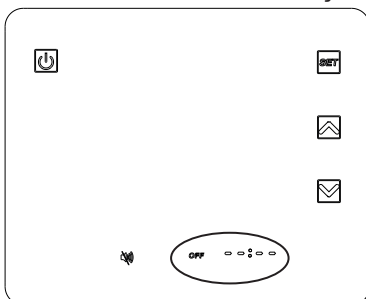





- 3) Premir , a indicação das horas pisca. Utilizar as setas   para ajustar as horas de início.
- 4) Premir , a indicação dos minutos pisca. Utilizar as setas   para ajustar os minutos de início. Premir  para validar.
- 5) Premir  para ajustar a hora de fim : a indicação **OFF** pisca.



## 4. INTERFACE DO UTILIZADOR (continuação)

---

- 6) Premir  a indicação das horas pisca. Utilizar as setas   para ajustar as horas de fim.
- 7) Premir  a indicação dos minutos pisca. Utilizar as setas   para ajustar os minutos de fim. Premir  para validar.
- 8) premir  para voltar ao ecrã anterior.

As indicações ON-OFF aparecem como no ecrã abaixo.

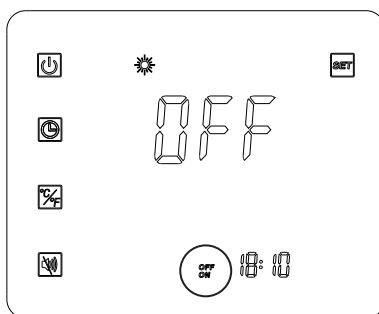

**Nota :** O passo de ajustamento dos minutos é de 10 em 10.

Uma vez o ajustamento do modo SILENCE terminado, este fica activo por defeito 7j/7j.

## 5. MANUTENÇÃO E PREPARAÇÃO PARA O INVERNO

---

### 5.1 Manutenção

Estas operações de manutenção devem ser realizadas 1 vez por ano a fim de garantir a longevidade e o bom funcionamento da bomba de aquecimento.

- Limpar o evaporador com a ajuda de uma escova macia ou jacto de ar ou água (**Atenção, nunca utilizar um aspersor de alta pressão**).
- Verificar o bom escoamento dos condensados.



***Antes de qualquer operação de manutenção a bomba de aquecimento deve ser desligada de qualquer fonte de corrente eléctrica. As operações de manutenção devem ser realizadas unicamente por pessoal qualificado e habilitado para manipular fluidos de refrigeração.***

- Verificar o aperto das ligações hidráulicas e eléctricas
- Verificar a estanqueidade hidráulica do condensador.

### 5.2 Preparação para o Inverno

- Colocar a bomba de aquecimento em Modo “OFF”.
- Cortar a alimentação da bomba de aquecimento.
- Esvaziar o condensador com a ajuda do dreno para evitar qualquer risco de degradação. (risco importante de congelação).
- Fechar a válvula de “by-pass” e desapertar as uniões de entrada/saída.
- Expulsar ao máximo a água residual do condensador com a ajuda de uma pistola de ar.
- Obturar a entrada e a saída de água na bomba de aquecimento para evitar a entrada de corpos estranhos.
- Cobrir a bomba de aquecimento com a capa de Inverno prevista para este efeito.



***Qualquer dano ocasionado por deficiente preparação para o Inverno implica a anulação da garantia.***

# 6. ANEXOS

## 6.1 Esquemas eléctricos

### ENP6MASC

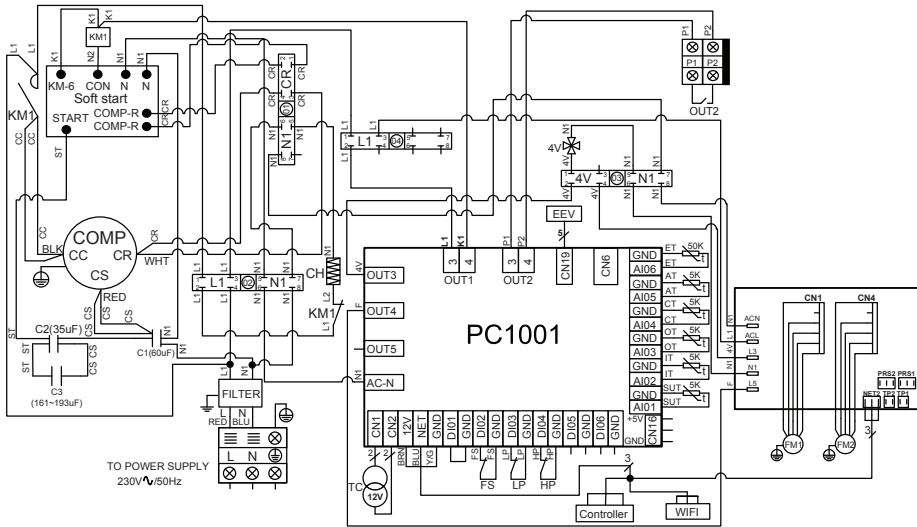

#### OBSERVAÇÕES:

1. AT : SONDA DE TEMPERATURA DO AR
2. COMP : COMPRESSOR
3. CT : SONDA TEMPERATURA EVAPORADOR
4. EEV : REGULADOR ELECTRÓNICO
5. FM1-2 : MOTOR VENTILADOR
6. FS : DETECTOR PRESENÇA DE ÁGUA
7. HP : PRESSÓSTATO ALTA PRESSÃO
8. IT : SONDA DE TEMPERATURA ENTRADA DE ÁGUA
9. LP : PRESSÓSTATO BAIXA PRESSÃO
10. OT : SONDA DE TEMPERATURA SAÍDA DE ÁGUA
11. SUT : SONDA DE TEMPERATURA DE ASPIRAÇÃO
12. TC : TRANSFORMADOR 230V~/ 12V~/
13. 4V : VÁLVULA DE 4 VIAS
14. KM1 : CONTACTOR DE POTÊNCIA
15. SOFT START : MOTOR DE ARRANQUE ELECTRÓNICO
16. CH : RESISTÊNCIA DE CAIXA
17. ET : SONDA DE TEMPERATURA DE DESCARGA
18. OUT2 : CONTACTO SECO LIVRE DE POTENCIAL 7A MÁX

## 6. ANEXOS (continuação)

### ENP6TASC - ENP7TASC

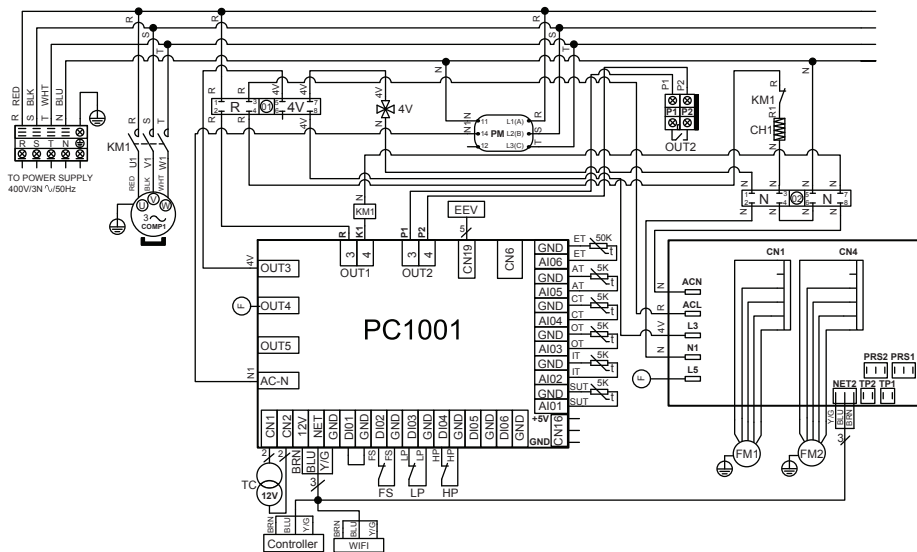

#### OBSERVAÇÕES:

1. AT : SONDA DE TEMPERATURA DO AR
2. COMP : COMPRESSOR
3. CT : SONDA TEMPERATURA EVAPORADOR
4. EEV : REGULADOR ELECTRONICO
5. FM1-2 : MOTOR VENTILADOR
6. FS : DETECTOR PRESENÇA DE ÁGUA
7. HP : PRESSÓSTATO ALTA PRESSÃO
8. IT : SONDA DE TEMPERATURA ENTRADA DE ÁGUA
9. LP : PRESSÓSTATO BAIXA PRESSÃO
10. OT : SONDA DE TEMPERATURA SAÍDA DE ÁGUA
11. SUT : SONDA DE TEMPERATURA DE ASPIRAÇÃO
12. TC : TRANSFORMADOR 230V∕∕ 12V∕∕
13. 4V : VÁLVULA DE 4 VIAS
14. KM1 : CONTACTOR DE POTÊNCIA
15. PM : CONTROLADOR DE FASE
16. CH1 : RESISTÊNCIA DE CAIXA
17. ET : SONDA DE TEMPERATURA DE DESCARGA
18. OUT2 : CONTACTO SECO LIVRE DE POTENCIAL 7A MÁX

## 6. ANEXOS (continuação)

### 6.2 Ligações prioridade aquecimento bomba monofásica

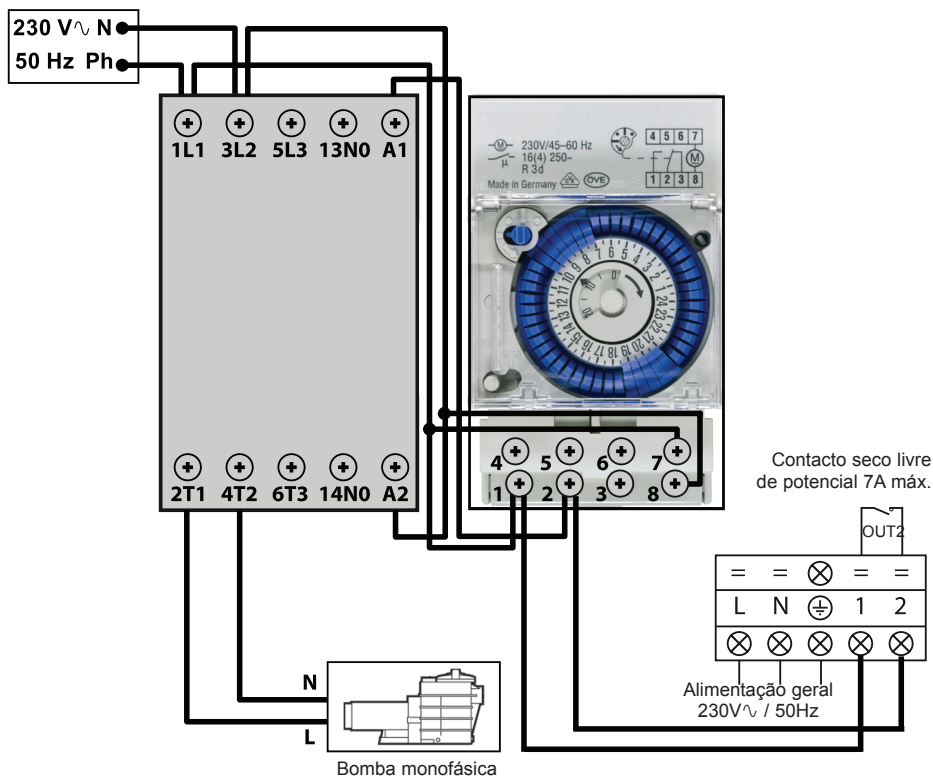

Os terminais 1 e 2 emitem um contacto seco livre de potencial, sem polaridade de 230 V $\sim$  / 50 Hz.

Cablar os terminais 1 e 2 respeitando a cablagem indicada acima, a fim de controlar o funcionamento da bomba de filtração por ciclo de 2 minutos todas as horas se a temperatura da bacia for inferior ao ponto recomendado.

 Nunca conecte a alimentação da bomba de filtração directamente sobre os terminais 1 e 2.



## 6. ANEXOS (continuação)

### 6.2 Ligações prioridade aquecimento bomba trifásica

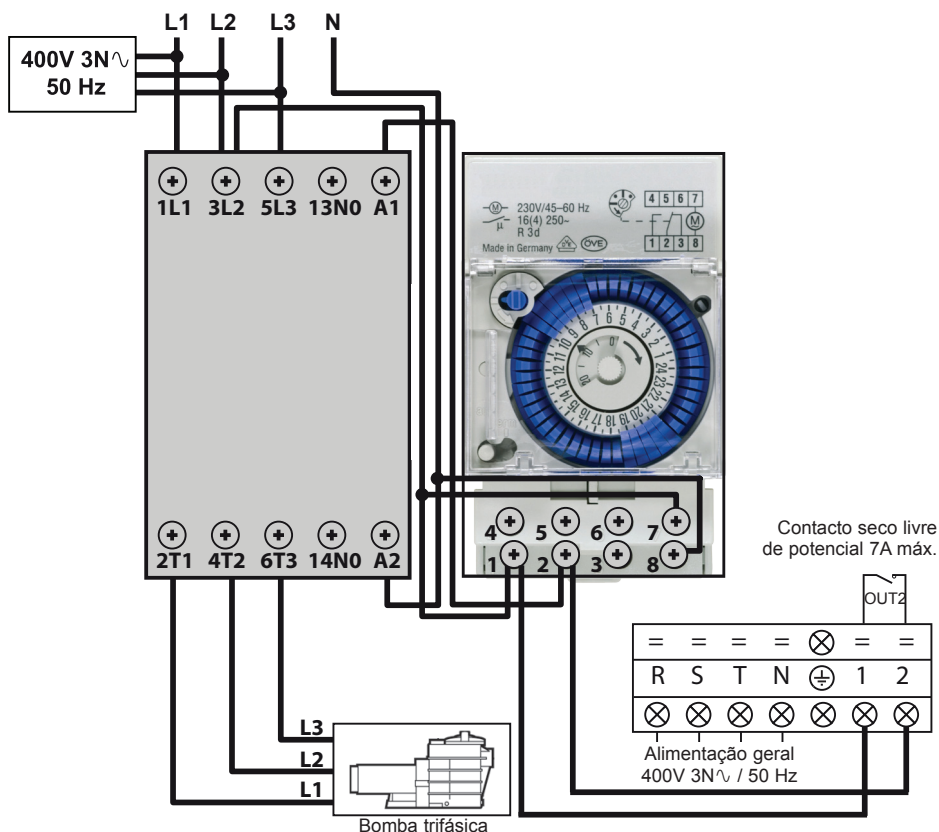

Os terminais 1 e 2 emitem um contacto seco livre de potencial, sem polaridade de 230 V  $\sim$  / 50 Hz.

Cablar os terminais 1 e 2 respeitando a cablagem indicada acima, a fim de controlar o funcionamento da bomba de filtração por ciclo de 2 minutos todas as horas se a temperatura da bacia for inferior ao ponto recomendado.

 Nunca conecte a alimentação da bomba de filtração directamente sobre os terminais 1 e 2.



## 6. ANEXOS (continuação)

### 6.3 Vistas explodidas e peças sobressalentes

ENP6MASC

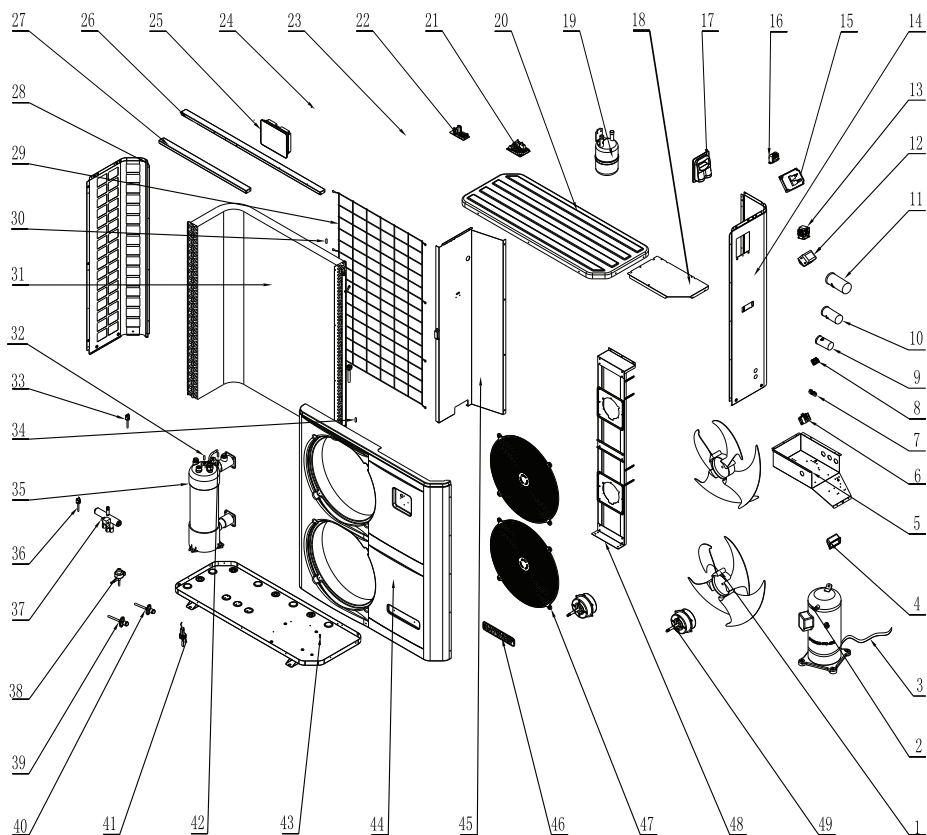



## 6. ANEXOS (continuação)

### ENP6MASC

Rep	Ref.	Designação	Rep	Ref.	Designação
1	HWX20000270004	Hélice ventilador	28	HWX32019210028	Painel esquerdo
2	HWX200011112	Compressor	29	HWX32019210031	Protecção Evaporador
3	HWX20003214	Resistência de cárter	30	HWX20003242	Sonda temperatura de ar
4	HWX32008220037	Punho	31	HWX32010120008	Evaporador
5	HWX32019210040	Bastidor eléctrico	32	HWX20003242	Sonda de entrada de água
6	HWX20003920	Terminal de 3 ligações	33	HWX20013605	Pressóstato alta pressão
7	HWX20003909	Terminal de 2 ligações	34	HWX20003242	Sonda temperatura evaporador
8	HWX20003933	Terminal de 3 ligações	35	HWX32010120023	Condensador Titane PVC
9	HWX20003504	Condensador compressor (35µF)	36	HWX20003603	Pressóstato baixa pressão
10	HWX20003510	Condensador compressor (60µF)	37	HWX20011491	Válvula de 4 vias
11	HWX20000350011	Condensador de arranque (193µF)	38	HWX20000140346	Regulador electrónico
12	HWX20003254	Filtro CEM	39	HWX20000140353	Tomada de pressão AP&BP
13	HWX200036007	Contactador Compressor mono	40	HWX20000140353	Tomada de pressão AP&BP
14	HWX32010210013	Painel direito	41	HWX200036005	Detector de débito de água
15	HWX20003151	Arrancador electrónico	42	HWX20003242	Sonda de saída de água
16	HWX200037003	Transformador 230V <sub>~</sub> / 12V <sub>~</sub>	43	HWX32019210061	Fundo
17	HWX32009220032	Alçapão de acesso eléctrico	44	HWX32019210049	Painel frontal
18	HWX32019210025	Painel de protecção eléctrica	45	HWX32019210026	Painel de separação
19	HWX20001440	Depósito de líquido	46	HWX20000230596	Logotipo Hayward
20	HWX32019220001	Painel superior	47	HWX20000220169	Grelha de protecção do ventilador
21	HWX95053114512E	Placa electrónica	48	HWX32019210022	Suporte Motor
22	HWX950531024103	Módulo DC Inverter	49	HWX20000330132	Motor DC
*23*	HWX20003223	Sonda Compressor 50kΩ	*50*	HWX20002625	Silentblock
24	/	/	*51*	HWX200026009	Junta tórica ID 43-Ep 3.4mm
25	HWX95005010018	Regulador LED	*52*	HWX200026061	Junta tórica ID 48-Ep 5mm
26	HWX32019210030	Enrijecedor Largo	*53*	HWX20000240112	Cobertura de inverno
27	HWX32019210029	Enrijecedor Pequeno	*54*	HWX20001345	Tampa de descarga

Nota : As marcas \*xx \*não estão referenciadas na vista explodida correspondente.

## 6. ANEXOS (continuação)

ENP6TASC

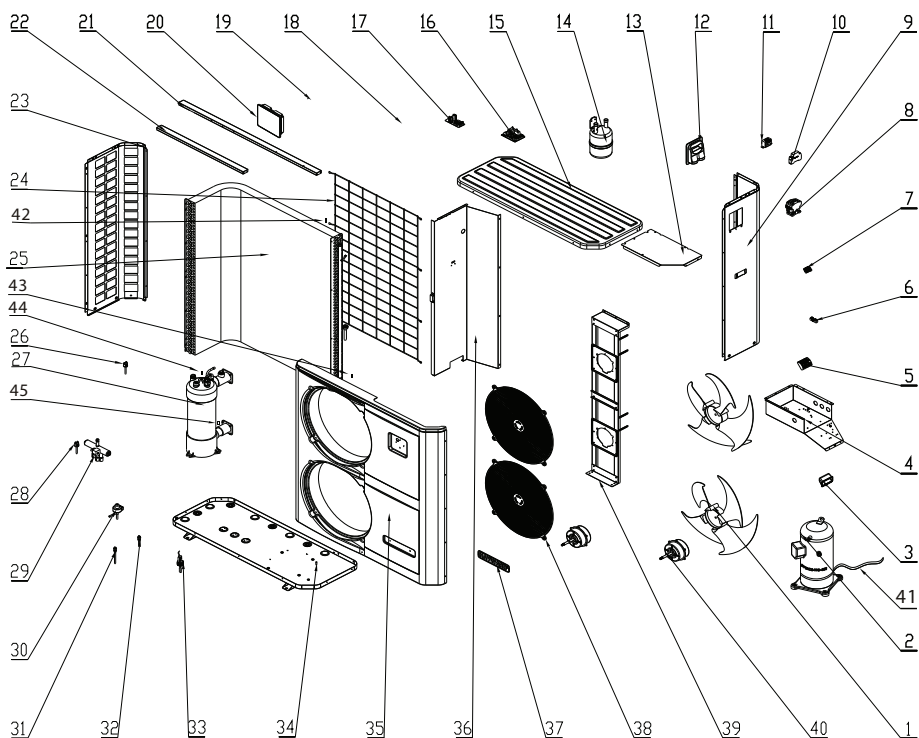

## 6. ANEXOS (continuação)

### ENP6TASC

Rep	Ref.	Designação	Rep	Ref.	Designação
1	HWX20000270004	Hélice ventilador	26	HWX20013605	Pressóstato alta pressão
2	HWX20000110146	Compressor	27	HWX32019120007	Condensador Titane PVC
3	HWX32008220037	Punho	28	HWX20003603	Pressóstato baixa pressão
4	HWX32019210024	Bastidor eléctrico	29	HWX20011491	Válvula de 4 vias
5	HWX20003902	Terminal de 5 ligações trifásico	30	HWX20000140346	Regulador electrónico
6	HWX20003909	Terminal de 2 ligações	31		
7	HWX20003933	Terminal de 3 ligações	32		
8	HWX20003653	Contacto Compressor trifásico	33	HWX200036005	Detetor de caudal de água
9	HWX32019210027	Painel direito	34	HWX32019210061	Fundo
10	HWX200036023	Controlador de fase	35	HWX32019210049	Painel frontal
11	HWX200037003	Transformador 230V <sub>~</sub> / 12V <sub>~</sub>	36	HWX32019210026	Painel de separação
12	HWX32009220032	Alçapão de acesso eléctrico	37	HWX20000230596	Logotipo Hayward
13	HWX32019210025	Painel de protecção eléctrica	38	HWX20000220169	Grelha de protecção do ventilador
14	HWX20001440	Depósito de líquido	39	HWX32019210022	Suporte Motor
15	HWX32019220001	Painel superior	40	HWX20000330132	Motor DC
16	HWX95053114510E	Placa electrónica	41	HWX20003214	Sonda temperatura de ar
17	HWX950531024101	Módulo DC Inverter	42	HWX20003242	Sonda temperatura de ar
*18*	HWX20003223	Sonda Compressor 50kΩ	43		Sonda temperatura evaporador
19	/	/	44		Sonda de entrada de água
20	HWX95005010018	Regulador LED	45		Sonda de saída de água
21	HWX32019210030	Enrijecedor Largo	*46*	HWX20002625	Bloco silencioso
22	HWX32019210029	Enrijecedor Pequeno	*47*	HWX200026009	Junta tórica ID 48-Ep 5mm
23	HWX32019210028	Painel esquerdo	*48*	HWX200026061	Junta tórica ID 43-Ep 3.4mm
24	HWX32019210031	Protecção Evaporador	*49*	HWX20000240112	Cobertura de inverno
25	HWX32010120008	Evaporador	*50*	HWX20001345	Tampa de descarga

Nota : As marcas \*xx \*não estão referenciadas na vista explodida correspondente.

## 6. ANEXOS (continuação)

### ENP7TASC

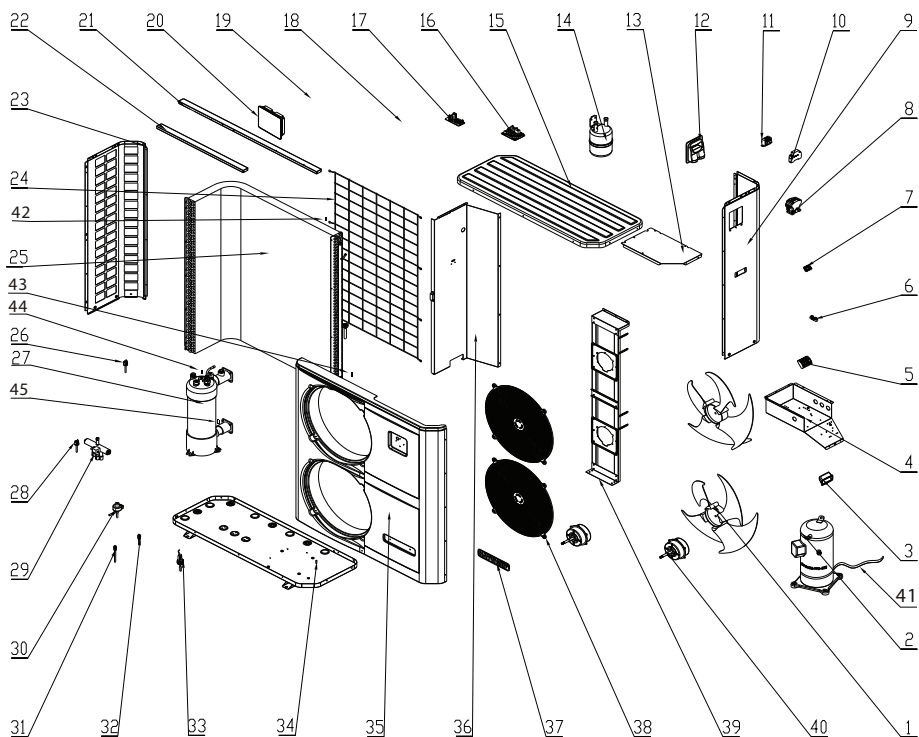

## 6. ANEXOS (continuação)

### ENP7TASC

Rep	Ref.	Designação	Rep	Ref.	Designação
1	HWX20000270004	Hélice ventilador	26	HWX20013605	Pressóstato alta pressão
2	HWX20000110138	Compressor	27	HWX32019120007	Condensador Titane PVC
3	HWX32008220037	Punho	28	HWX20003603	Pressóstato baixa pressão
4	HWX32019210024	Bastidor eléctrico	29	HWX20011491	Válvula de 4 vias
5	HWX20003902	Terminal de 5 ligações trifásico	30	HWX20000140398	Regulador electrónico
6	HWX20003909	Terminal de 2 ligações	31		
7	HWX20003933	Terminal de 3 ligações	32		
8	HWX20003653	Contactora Compressor trifásico	33	HWX200036005	Detector de débito de água
9	HWX32019210027	Painel direito	34	HWX32019210061	Fundo
10	HWX200036023	Controlador de fase	35	HWX32019210049	Painel frontal
11	HWX200037003	Transformador 230V <sub>v</sub> / 12V <sub>v</sub>	36	HWX32019210026	Painel de separação
12	HWX32009220032	Alcapão de acesso eléctrico	37	HWX20000230596	Logotipo Hayward
13	HWX32019210025	Painel de protecção eléctrica	38	HWX20000220169	Grelha de protecção do ventilador
14	HWX20001440	Depósito de líquido	39	HWX32019210022	Suporte Motor
15	HWX32019220001	Painel superior	40	HWX20000330132	Motor DC
16	HWX95053114511E	Placa electrónica	41	HWX20003214	Resistência de cárter
17	HWX950531024102	Módulo DC Inverter	42	HWX20003242	Sonda temperatura de ar
*18*	HWX20003223	Sonda Compressor 50kΩ	43		Sonda temperatura evaporador
19	/	/	44		Sonda de entrada de água
20	HWX95005010018	Regulador LED	45		Sonda de saída de água
21	HWX32019210030	Enrijecedor Largo	*46*	HWX20002625	Bloco silencioso
22	HWX32019210029	Enrijecedor Pequeno	*47*	HWX200026009	Junta tórica ID 48-Ep 5mm
23	HWX32019210028	Painel esquerdo	*48*	HWX200026061	Junta tórica ID 43-Ep 3.4mm
24	HWX32019210031	Protecção Evaporador	*49*	HWX20000240112	Cobertura de inverno
25	HWX32019120002	Evaporador	*50*	HWX20001345	Tampa de descarga

Nota : As marcas \*xx \*não estão referenciadas na vista explodida correspondente.

## 6. ANEXOS (continuação)

---

### 6.4 Guia de resolução de avarias



*Certas operações devem ser realizadas por um técnico habilitado.*

Em caso de falha, as indicações seguintes aparecem no ecrã:

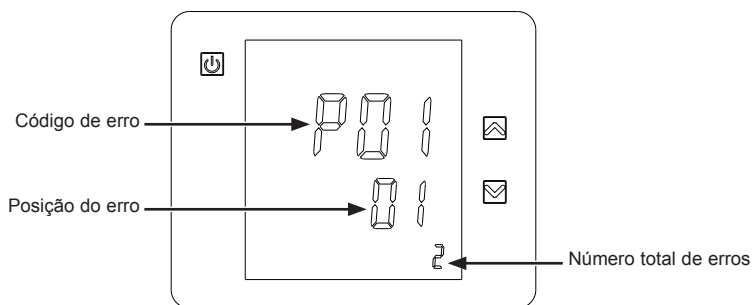

Em caso de vários erros, pressionar  ou  para percorrer os códigos de erro. Consultar a tabela seguinte.

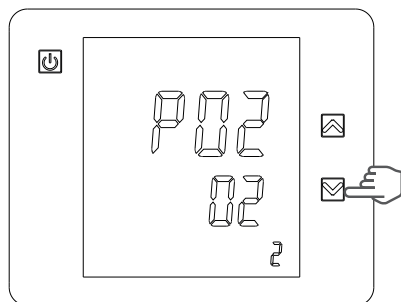

## 6. ANEXOS (continuação)

Avaria	Códigos de erro	Descrição	Solução
Avaria sonda de entrada de água	P01	O sensor está aberto ou apresenta curto-circuito.	Verificar ou substituir o sensor.
Avaria sonda de saída de água	P02	O sensor está aberto ou apresenta curto-circuito.	Verificar ou substituir o sensor.
Avaria sonda descongelação	P05	O sensor está aberto ou apresenta curto-circuito.	Verificar ou substituir o sensor.
Avaria sonda temperatura exterior	P04	O sensor está aberto ou apresenta curto-circuito.	Verificar ou substituir o sensor.
Defeito sonda de aspiração compressor	P07	O sensor está aberto ou apresenta curto-circuito.	Verificar ou substituir o sensor.
Diferença de temperatura excessiva entre a água na saída e a água na entrada	E06	Débito de água em volume insuficiente, diferença de pressão de água demasiado fraca / elevada.	Verificar o débito de água, ou a obstrução do sistema.
Protecção Antigelado Modo frio	E07	Quantidade de água na saída insuficiente.	Verificar o débito de água, ou o sensor de temperatura da água na saída.
Protecção antigelo de nível 1	E19	Temperatura ambiente, ou na água de entrada, demasiado baixa.	
Protecção antigelo de nível 2	E29	Temperatura ambiente, ou na água de entrada ainda mais baixa.	
Protecção de alta pressão	E01	Pressão do circuito refrigerador demasiado elevada, ou débito de água demasiado fraco, ou evaporador obstruído, ou débito de ar insuficiente.	Verificar o pressóstato de alta pressão e a pressão do circuito refrigerador. Verificar o débito de ar ou de água. Verificar o bom funcionamento do controlador de débito. Verificar a abertura das válvulas de entrada/saída de água. Verificar a Ajuste da válvula de by-pass.
Protecção de baixa pressão	E02	Pressão do circuito de refrigeração demasiado fraca, ou débito de ar demasiado fraco ou evaporador obstruído.	Verificar o pressóstato de baixa pressão de baixa pressão e a pressão do circuito refrigerador para avaliar se existe fuga. Limpar a superfície do evaporador. Verificar a velocidade de rotação do ventilador. Verificar a livre circulação de ar através do evaporador.
Avaria detector de débito	E03	Débito de água insuficiente ou detector em curto-circuito ou avariado	Verificar o débito de água, a bomba de filtração e o detector de débito para ver se apresentam eventuais anomalias de funcionamento.
Problema de comunicação	E08	Anomalia de funcionamento do controlador LED ou da ligação PCB.	Verificar a conexão dos cabos NET e NET 1.
O compressor não arranca	E08	Falta uma fase ou ordem das fases incorrecta	verificar a presença das 3 fases modificar a ordem das fases ao nível do terminal ligação eléctrica à bomba de calor

## 6. ANEXOS (continuação)

---

### 6.5 Garantia

#### CONDIÇÕES DE GARANTIA

Todos os produtos HAYWARD são garantidos contra todos os defeitos de fabrico ou de matéria-prima durante um período de dois anos a contar da data de aquisição. Qualquer reclamação de garantia deverá ser acompanhada de uma prova de compra contendo a data. Recomendamos, assim, que conserve a sua factura.

A garantia HAYWARD é limitada à reparação ou substituição, por opção da HAYWARD, dos produtos defeituosos desde que tenham sido submetidos a uma utilização normal, em conformidade com as prescrições mencionadas no respectivo manual de utilização, que o produto não tenha sido modificado de nenhuma forma e tenha sido utilizado unicamente com componentes e peças da HAYWARD. Os danos devidos ao gelo e aos ataques de agentes químicos não são garantidos. Todas as outras despesas (transporte, mão-de-obra...) estão excluídas da garantia.

A HAYWARD não poderá ser considerada responsável por qualquer dano directo ou indirecto proveniente da instalação, da ligação ou do funcionamento incorrecto do produto.

Para fazer aplicar uma garantia ou solicitar a reparação ou substituição de um artigo, dirija-se ao seu revendedor. Não será aceite qualquer devolução de material à nossa fábrica sem o nosso acordo prévio por escrito. As peças de desgaste não se encontram cobertas pela garantia.



ISENPASC Rev C

# ***ENERGYLINE PRO***

**HEIZPUMPENANLAGE FÜR EIN SCHWIMMBECKEN**



**Einbau- & Anleitungshandbuch**

# INHALTSVERZEICHNIS

---

<b>1. Vorwort</b>	<b>1</b>
<hr/>	
<b>2. Technische Eigenschaften</b>	<b>2</b>
2.1 Technische Daten der Heizpumpenanlage für ein Schwimmbecken	2
2.2 Betriebsbereich	3
2.3 Maße	4
<hr/>	
<b>3. Installation und Anschluss</b>	<b>5</b>
3.1 Schematische Darstellung	5
3.2 Heizpumpenanlage	6
3.3 Hydraulikanschluss	6
3.4 Elektroanschluss	7
3.5 Erste Inbetriebnahme	8
3.6 Einstellung des Wasserdurchsatzes	10
<hr/>	
<b>4. Benutzeroberfläche</b>	<b>11</b>
4.1 Allgemeine Darstellung	11
4.2 Einstellung der Uhr	13
4.3 Einstellung der Tuner-Funktion	13
4.4 Wahl des Funktionsmodus	14
4.5 Einstellung und Anzeige des Sollwerts	15
4.6 Sperren und Freigeben des Touchscreen	15
4.7 Einstellen des Ruhemodus	16
<hr/>	
<b>5. Wartung und Winterzeit</b>	<b>19</b>
5.1 Wartung	19
5.2 Winterzeit	19
<hr/>	
<b>6. Anhang</b>	<b>20</b>
6.1 Stromschaltpläne	20
6.2 Vorrangige Heizanschlüsse	22
6.3 Explosionszeichnungen und Einzelteile	24
6.4 Anleitung zur Fehlerbehebung	30
6.5 Garantie	32

Aufmerksam lesen und für einen späteren Gebrauch aufzubewahren.

Dieses Dokument ist dem Eigentümer des Schwimmbeckens zu übergeben und muss von diesem an einem sicheren Ort aufbewahrt werden.

# 1. VORWORT

---

Wir bedanken uns bei Ihnen für den Kauf dieser Heizpumpenanlage für ein Schwimmbecken der Marke Hayward. Dieses Produkt wurde unter strikter Einhaltung der Herstellungsrichtlinien gefertigt, um dem Niveau der erforderlichen Qualität gerecht zu werden. Das vorliegende Handbuch beinhaltet alle notwendigen Informationen zur Installation, zur Fehlerbehebung und zur Wartung. Lesen Sie dieses Handbuch aufmerksam durch, bevor Sie die Anlage öffnen oder Wartungsarbeiten durchführen. Der Hersteller dieses Produkts übernimmt keinerlei Haftung bei Personen- oder Sachschäden an der Anlage, die infolge einer unsachgemäßen Installation, einer unbefugten Fehlerbehebung oder einer unnötigen Wartung, entstehen. Es ist wichtig, den in diesem Handbuch beschriebenen Anleitungen stets Folge zu leisten. Die Anlage muss von einem qualifizierten Fachmann installiert werden.

- Reparaturen dürfen nur von einem Fachmann durchgeführt werden.
- Alle Elektroanschlüsse müssen von einem qualifizierten Elektriker gemäß der in dem Land, in dem die Anlage installiert wird, geltenden Richtlinien durchgeführt werden, s. § 3.4.
- Die Wartung und die verschiedenen Betriebsabläufe müssen gemäß den in diesem Handbuch beschriebenen Zeiträumen und Häufigkeiten durchgeführt werden.
- Benutzen Sie ausschließlich Originalersatzteile.
- Im Falle einer Nichtbeachtung dieser Anweisungen erlischt der Garantieanspruch.
- Diese Heizpumpenanlage für ein Schwimmbecken erwärmt das Wasser im Schwimmbad und hält eine konstante Temperatur. Sie darf nicht zu anderen Zwecken genutzt werden.

Nachdem Sie dieses Handbuch gelesen haben, halten Sie es stets zum Nachschlagen bereit.

Warnhinweise bezüglich Kinder / Personen mit eingeschränkten körperlichen Fähigkeiten:

Dieses Gerät wurde nicht konzipiert, um von Personen (insbesondere Kindern), deren körperlichen, sensorischen oder geistigen Fähigkeiten eingeschränkt sind, bzw. von Personen, denen es an Erfahrung oder Wissen mangelt, benutzt zu werden, sofern diese nicht unter der Aufsicht einer für ihre Sicherheit verantwortlichen Person stehen oder eine Einweisung in die Nutzung dieses Gerätes durch eben diese erhalten haben.

Dieses Produkt enthält gemäß dem Kyoto-Protokoll Gase mit Treibhauseffekt.

Art des Kühlmittels: R410A

Höhe des Valeur GWP (= potential de rechauffement globale, Möglichkeit der globalen Erwärmung, Anm. d. Übers.)<sup>(1)</sup>: 1975

Regelmäßige Inspektionen des Austritts von Kühlmittel können gemäß der europäischen Gesetzgebung oder der des jeweiligen Landes verlangt werden. Für weitere Informationen kontaktieren Sie bitte Ihren Händler vor Ort.

---

(1) Möglichkeit der globalen Erwärmung

## 2. TECHNISCHE EIGENSCHAFTEN

### 2.1 Technische Angaben zur Heizpumpenanlage

Modelle	ENERGYLINE PRO	ENP6MASC	ENP6TASC	ENP7TASC
Wärmeerzeugende Kapazität *	kW	17,8	18,2	23,4
Elektrische Antriebsleistung *	kW	3,69	3,7	5,15
Funktionsweise *	A	16,2	7,69 / 6,89 / 6,33	9,71 / 8,01 / 7,70
Versorgungsspannung	V Ph/Hz	230V~ 50Hz	400V 3N~ 50Hz	400V 3N~ 50Hz
Sicherungsdurchmesser Typ aM	A	20	12	16
Leistungsschalter Kurve D	A	20	12	16
Kompressorennummer		1	1	1
Kompressorart		Scroll	Scroll	Scroll
Anzahl der Gebläse		2	2	2
Stärke der Gebläse	W	50 — 225	50 — 225	50 — 225
Rotationsgeschwindigkeit der Ventilatoren	RPM	600 — 950	830 — 960	800 — 1050
Gebläse		Horizontal	Horizontal	Horizontal
Geräuschdruckpegel (bei 1 Meter)	dB(A)	45	45	47
Hydraulikanschluss	mm	50	50	50
Nominaler Wasserdurchsatz*	m <sup>3</sup> /h	6,6	6,6	8
Verlust der Last auf dem Wasser (max.)	kPa	7	7	18
Reinmaße der Anlage (Länge/ Breite/Höhe)	mm	1138 / 470 / 1264	1138 / 470 / 1264	1138 / 470 / 1264
Reingewicht der Einheit	kg	127	123	140



\* Werte +/- 5% unter folgenden Voraussetzungen: Außentemperatur = 15°C (59°F) / relative Luftfeuchtigkeit = 71% / Temperatur bei Wassereintritt = 26°C (78,8°F)  
In Übereinstimmung mit den Anforderungen von NF-414 (ganzjährige Nutzung).

## 2. TECHNISCHE EIGENSCHAFTEN (Fortsetzung)

---

### 2.2 Betriebsbereich

Benutzen Sie die Heizpumpenanlage innerhalb der folgenden Temperatur- und Luftfeuchtigkeitsbereichen, um ein sicheres und effizientes Funktionieren zu garantieren.

	Modus Erwärmen 	Modus Abkühlen 
Außentemperatur	-12°C ~ +35°C	+7°C ~ +43°C
Wassertemperatur	+12°C ~ +40°C	+8°C ~ +40°C
relative Luftfeuchtigkeit	< 80%	< 80%
Einstellbereich des Sollwerts	+15°C ~ +32°C	+8°C ~ +32°C



**Wenn Temperatur oder Luftfeuchtigkeit nicht diesen Bedingungen entsprechen, können Sicherheitsmaßnahmen ausgelöst werden. Dann arbeitet die Heizpumpenanlage nicht mehr.**



**Die Höchsttemperatur für die Beheizung beträgt 32 °C, um eine Beschädigung der Verkleidung zu vermeiden. Hayward übernimmt keinerlei Verantwortung bei einer Verwendung über +32 °C.**

## 2. TECHNISCHE EIGENSCHAFTEN (Fortsetzung)

### 2.3 Maße

Modelle: ENP6MASC / ENP6TASC / ENP7TASC

Anlage: mm

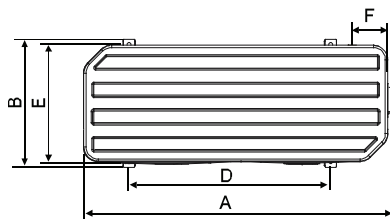
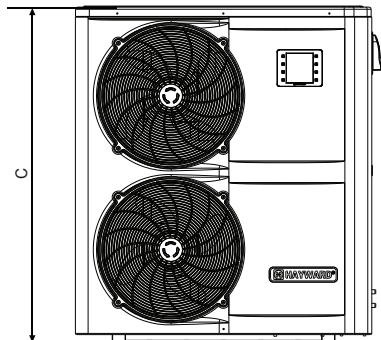
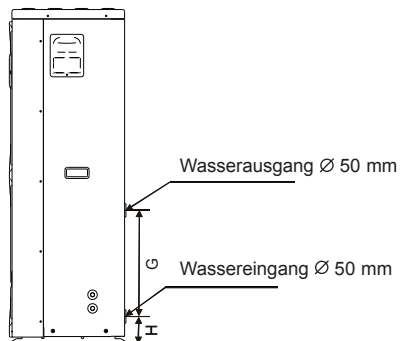

TYPE SIZE (mm)	ENP6MASC	ENP6TASC ENP7TASC
A	1138	1138
B	470	470
C	1264	1264
D	790	790
E	447	447
F	114	114
G	500	400
H	104	104

# 3. INSTALLATION UND ANSCHLUSS

## 3.1 Schematische Darstellung

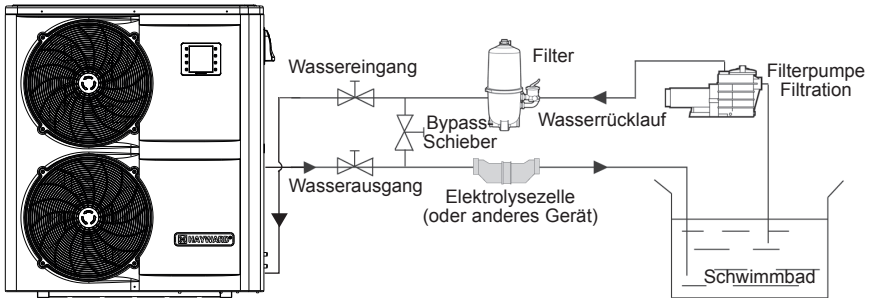

Anmerkung: Die Heizpumpenanlage verfügt über keinerlei Ausstattungs- oder Filtergerät. Die auf der Darstellung gezeigten Elemente werden vom Installateur bereitgestellt.

## 3.2 Heizpumpenanlage



**Stellen Sie die Heizpumpenanlage im Außenraum und außerhalb vollständig geschlossener technischer Orte auf.**

**Geschützt aufgestellt muss der vorgeschriebene Mindestabstand wie unten genannt eingehalten werden, um die Gefahr einer Luftrückführung oder einer Minderung der effektiven Betriebsleistung der Heizpumpenanlage zu vermeiden.**

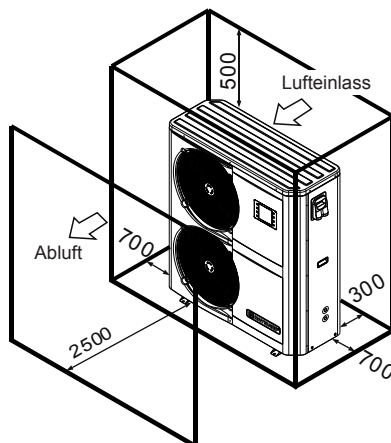

### 3. INSTALLATION UND ANSCHLÜSSE (Fortsetzung)



**Installieren Sie vorzugsweise die Heizpumpenanlage auf einer separaten Betonbodenplatte oder auf einer festen Bestuhlung, die für diesen Zweck bestimmt ist und stellen Sie die Heizpumpenanlage auf die mitgelieferten Silentblöcke (Verschraubung und Unterlegscheiben nicht mitgeliefert).**

**Maximale Entfernung zwischen Heizpumpenanlage und Schwimmbecken 15 Meter.**

**Gesamtlänge (hin und zurück) der hydraulischen Leitungen 30 Meter.**

**Isolieren Sie sowohl die sichtbaren als auch die verdeckten hydraulischen Leitungen.**

#### 3.3 Hydraulischer Anschluss

Die Heizpumpenanlage wird mit zwei Verbindungsstücken mit einem Durchmesser von 50 mm geliefert. Verwenden Sie PVC-Rohre mit 50 mm Durchmesser für das hydraulische Leitungsnetz. Schließen sie die den Wassereinlass der Heizpumpenanlage an die Leitung der Filtergruppe an. Schließen Sie dann den Wasserausgang der Heizpumpenanlage an die Wasserleitung des Beckens an (s. Darstellung weiter unten).

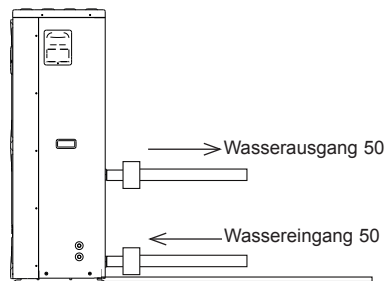

Installieren Sie einen Schieber, den so genannten "By-pass", zwischen den Eingang und den Ausgang der Heizpumpenanlage.



**Wird ein automatischer Verteiler oder ein Elektrolyseur verwendet, muss dieser unbedingt nach der Heizpumpenanlage eingebaut werden, um so den Titan-Kondensator gegen eine zu hohe Konzentration chemischer Produkte zu schützen.**



**Achten Sie darauf, den By-pass-Schieber und die Verbindungsstücke am Ein- und Auslass der Anlage einzubauen, um den problemlosen Ablass der Anlage während der Wintermonate und einen einfacheren Zugang oder einen Abbau bei Wartungsarbeiten zu erleichtern.**



# 3. INSTALLATION UND ANSCHLÜSSE (Fortsetzung)

## 3.4 Elektrischer Anschluss



**Die Elektroinstallation und die Verkabelung dieses Gerätes müssen den geltenden Installationsvorschriften vor Ort entsprechen.**

F	NF C15-100	GB	BS7671:1992
D	DIN VDE 0100-702	EW	EVHS-HD 384-7-702
A	ÖVE 8001-4-702	H	MSZ 2364-702/1994/MSZ 10-553 1/1990
E	UNE 20460-7-702 1993, RECBT ITC-BT-31 2002	M	MSA HD 384-7-702.S2
IRL	Wiring Rules (Richtlinien elektrischer Leitungen, Anm. d. Übers.) + IS HD 384-7-702	PL	PN-IEC 60364-7-702:1999
I	CEI 64-8/7	CZ	CSN 33 2000 7-702
LUX	384-7.702 S2	SK	STN 33 2000-7-702
NL	NEN 1010-7-702	SLO	SIST HD 384-7-702.S2
P	RSIUEE	TR	TS IEC 60364-7-702



**Prüfen Sie, ob die verfügbare Stromversorgung und die Netzfrequenz den den erforderlichem Betriebsstrom entsprechen. Dabei müssen der jeweilige Standort des Gerätes und der erforderliche Strombedarf aller anderen, am gleichen Schaltkreis angeschlossener Geräte berücksichtigt werden.**

**ENP6MASC 230 V $\sim$  +/- 10 % 50 Hz 1 Phase**

**ENP6TASC 400 V $\sim$  +/- 10 % 50 Hz 3 Phases**

**ENP7TASC 400 V $\sim$  +/- 10 % 50 Hz 3 Phases**



**Überprüfen, dass das Gleichgewicht der Phasen 2 % nicht übersteigt.**

**Beachten Sie die schematische Darstellung der Verkabelung im Anhang. Die Anschlussbox befindet sich auf der rechten Seite der Anlage. Es gibt drei Anschlüsse für die Stromversorgung und zwei für die Steuerung der Filterpumpe (Nachlaufsteuerung).**

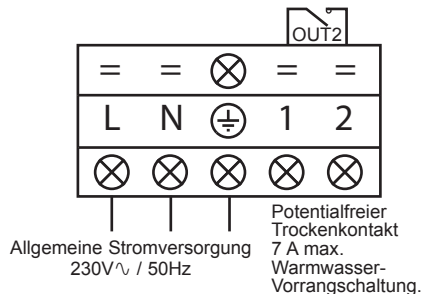
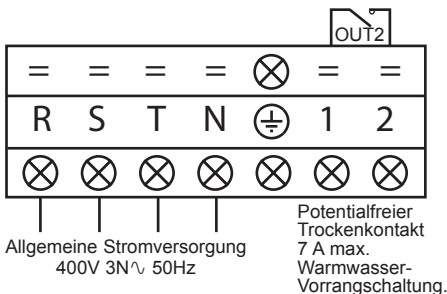

### 3. INSTALLATION UND ANSCHLUSS (Fortsetzung)



**Die Leitung der Stromversorgung muss ordnungsgemäß mit einer Gerätesicherung vom Typ Motorversorgung (aM) oder einem Hauptschalter D sowie einem Differentialschalter 30mA ausgestattet sein (siehe nachfolgende Tafel).**

Modelle		ENP6MASC	ENP6TASC	ENP7TASC
Netzteil	V/Ph/Hz	230V~ 50Hz	400V 3N~ 50Hz	400V 3N~ 50Hz
Sicherungsdurchmesser Typ aM	A	20 aM	12 aM	16 aM
Leistungsschalter Kurve D	A	20 D	12 D	16 D
Leitungsquerschnitt	mm <sup>2</sup>	3G6 3 x 6	5G2,5 5 x 2,5	5G2,5 5 x 2,5



**Ein Netzkabel vom Typ RO 2V / R 2V oder vergleichbar.**



**Die Leitungsquerschnitte werden für maximal 25 m Länge angegeben. Sie müssen gleichwohl überprüft und auf die Installationsbedingungen angepasst werden.**



**Achten Sie stets darauf, dass die Hauptstromversorgung abgeschaltet ist, bevor Sie den elektrischen Steuerkasten öffnen.**

#### 3.5 Erste Inbetriebnahme

Verfahren zur Inbetriebnahme - Nachdem Sie die Installation beendet haben, gehen Sie wie folgt vor:

- 1) Drehen Sie die Ventilatoren von Hand, um zu überprüfen, dass sie sich frei von Hand bewegen lassen und dass der Propeller korrekt auf der Antriebswelle befestigt ist.
- 2) Vergewissern Sie sich, dass die Einheit korrekt an die Hauptstromversorgung angeschlossen ist (siehe Schaltplan im Anhang).
- 3) Starten Sie die Filterpumpe.
- 4) Vergewissern Sie sich, dass alle Wasserein- und auslässe offen sind und dass das Wasser in die Anlage, bevor es erwärmt oder abgekühlt wird.
- 5) Vergewissern Sie sich, dass das Ablassrohr für das Kondensat ordnungsgemäß befestigt und frei von Blockaden ist.
- 6) Aktivieren Sie die Stromversorgung für die Anlage und drücken Sie dann den Start/Stop-Knopf  auf der Bedientafel.

### 3. INSTALLATION UND ANSCHLUSS (Fortsetzung)

- 7) Vergewissern Sie sich, dass kein ALARM-Code angezeigt wird, wenn die Anlage auf ON steht (siehe Anleitung zur Fehlerbehebung).
- 8) Arretieren Sie den Wasserdurchsatz mit dem By-pass-Schieber (s. § 3.6 und 2.1), wie für das jeweilige Modell vorgeschrieben, so dass eine Temperaturdifferenz zwischen Wasserein- und -ausgang von 2°C beibehalten wird.
- 9) Nachdem die Anlage einige Minuten in Betrieb ist, vergewissern Sie sich, dass die Luft, die aus der Anlage ausströmt, sich abgekühlt hat (um 5 bis 10°).
- 10) Ist die Anlage in Betrieb, schalten Sie die Filterpumpe ab. Die Anlage sollte sich automatisch abschalten und den Fehlercode E03 anzeigen.
- 11) Lassen sie die Anlage und die Schwimmbadpumpe 24 Stunden am Tag laufen, bis die gewünschte Wassertemperatur im Pool erreicht ist. Sobald das Eingangswasser die gewünschte Temperatur erreicht hat, schaltet sich die Anlage ab. Sie wird sich dann wieder automatisch einschalten (sofern die Schwimmbadpumpe in Betrieb ist), wenn die Temperatur des Schwimmbadwassers um mehr als 0,5°C von der eingestellten Temperatur abweicht.

**Wasserdurchsatzregler** - Die Anlage ist mit einem Regler für den Wasserdurchsatz ausgestattet, der diese einschaltet, wenn die Pumpe des Schwimmbadfilters in Betrieb ist und der diese ausschaltet, wenn die Filterpumpe außer Betrieb ist. Fehlt Wasser, so erscheint der Alarm-Code E03 auf dem Regler (siehe § 6.4).

**Zeitliche Verzögerung** - Die Anlage enthält eine zeitliche Verzögerung von 3 Minuten, welche die Komponenten des Steuerschaltkreises schützt und jegliche Instabilität bezüglich eines Neustarts sowie jegliche Störung im Bereich des Kontaktgebers verhindert. Aufgrund dieser zeitlichen Verzögerung startet die Anlage ca. 3 Minuten nach jeder Unterbrechung des Steuerschaltkreises automatisch neu. Selbst eine kurze Stromunterbrechung aktiviert diese zeitliche Verzögerung.

**Phasenwächter** - Die Dreiphaseneinheiten besitzen einen integrierten Phasenwächter, um die ordnungsgemäße Drehrichtung des Kompressors zu sichern. Falls die Einheit nicht anläuft, die Statusanzeige des im Schaltkasten befindlichen Phasenwächters kontrollieren.

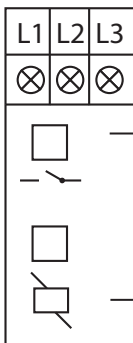

Gelb/Orange ON = Relais ON = Phasenfolge und -anzahl i. O.

Grün = anliegende Betriebsspannung

### 3. INSTALLATION UND ANSCHLUSS (Fortsetzung)

#### 3.6 Einstellung des Wasserdurchsatzes

Stellen Sie den so genannten By-pass-Schieber bei geöffneten Wassereinlass- und -auslassschiebern so ein, dass eine Unterschied von 2°C zwischen der Wassereingangstemp. und der Wasserausgangstemp. erreicht wird (siehe Schematische Darstellung § 3.1). Sie können die Einstellung der Eingangs- und Ausgangstemperaturen direkt auf der Bedientafel kontrollieren.

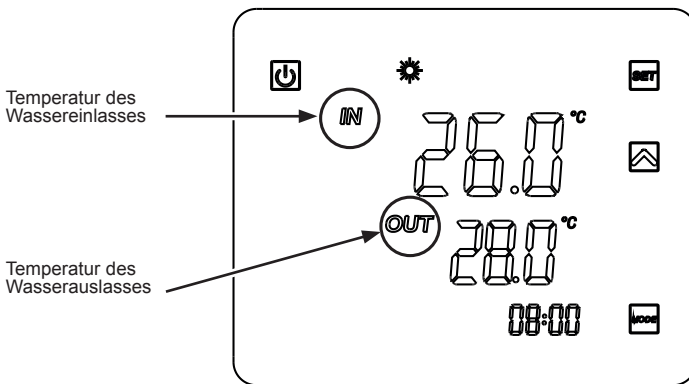

Anmerkung: Das Öffnen des By-pass-Schiebers führt zu einem geringeren Durchsatz oder zu einer Zunahme des  $\Delta T$ .  
Das Schließen des By-pass-Schiebers führt zu einem höheren Durchsatz oder zu einer Verringerung des  $\Delta T$ .

# 4. BENUTZERBEREICH

## 4.1 Allgemeine Darstellung

Die Heizpumpenanlage ist mit einem digitalen Touchscreen-Bedienfeld ausgestattet, elektronisch angeschlossen und werksseitig auf Heizmodus voreingestellt.

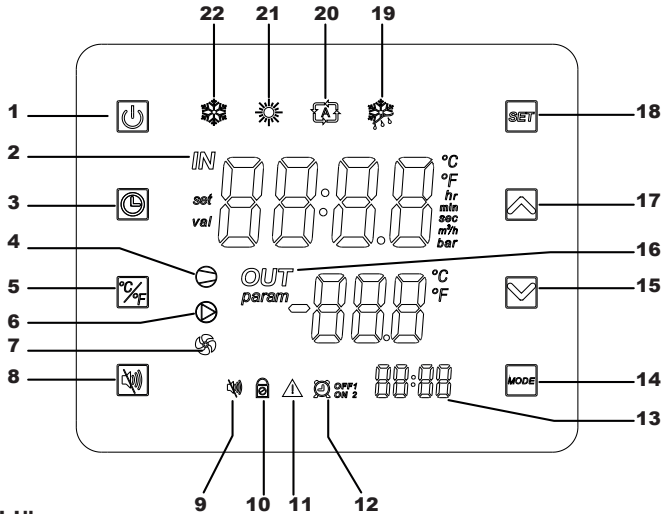

### Zeichenerklärung

1		Start/Stop
2	<i>IN</i>	Wassereinlass
3		Uhrzeit- und Timereinstellung
4		Kompressor ON
5		Umstellung °C/°F
6		Trockenkontakt OUT2
7		Fan ON
8		Ruhemodus
9		Kontrollleuchte Ruhemodus
10		Bildschirm gesperrt
11		Alarm

12		Timers 1 und 2
13		Uhrzeit für die Timer
14	<b>MODE</b>	Modus-Auswahl
15		Nach unten scrollen / Verringern
16	<i>OUT</i>	Wasserauslass
17		Nach oben scrollen / Erhöhen
18	<b>SET</b>	Sicherung / Einstellungen
19		Abtauenmodus
20		Automatikmodus
21		Heizmodus
22		Kühlmodus

## 4. BENUTZEROBERFLÄCHE (Fortsetzung)

---

### Modus OFF

Befindet sich die Heizpumpenanlage im Stand-by-Modus (Modus OFF), erscheint im Bedienfeld die Anzeige "OFF".

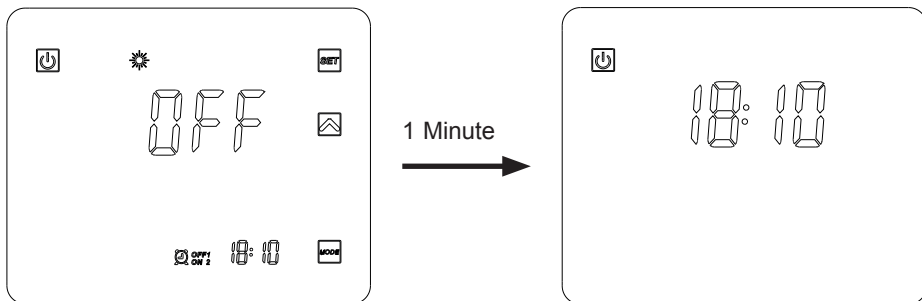

### Modus ON

Befindet sich die Heizpumpenanlage in Betrieb oder in der Regulierung (Modus ON), so erscheinen die Temperaturen des eintretenden und des austretenden Wassers im Bedienfeld.

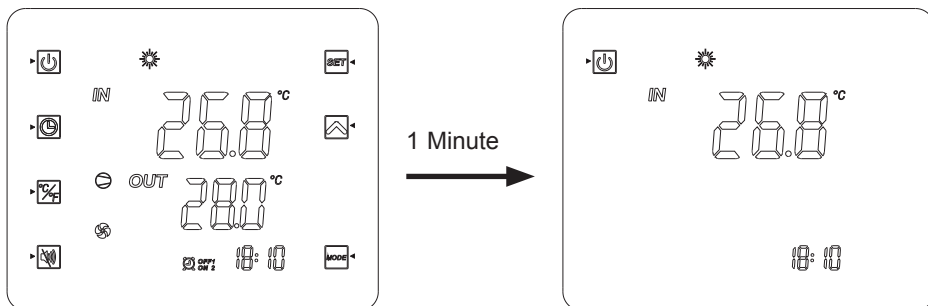









## 4. BENUTZEROBERFLÄCHE (Fortsetzung)

Am Ende der Einstellungen, drücken Sie , um zu bestätigen.  
Aufnahme-Einstellungen automatisch nach 20s ohne Aktion.

### 4.2 Einstellung der Uhr









Wenn das Display im Standby-Modus ist, drücken Sie kurz auf die Taste .

- 1) Drücken Sie auf  damit das Symbol  erscheint.
- 2) Drücken Sie auf , die Stundenanzeige blinkt. Stellen Sie die Stunden mit den Tasten   ein.
- 3) Drücken Sie auf  und stellen Sie dann die Minuten mit den Tasten   ein.
- 4) Drücken Sie auf  zur Bestätigung.











### 4.3 Einstellung der Timer-Funktion



Die Einstellung dieser Funktion ist notwendig, wenn Sie die Heizpumpenanlage über einen kürzeren als den von der Filteruhr vorgegebenen Zeitraum betreiben möchten. Damit können Sie einen zeitlich versetzten Beginn oder ein vorzeitiges Ende programmieren bzw. einen Teilbereich des Betriebszeitplans unterbinden (zum Beispiel nachts). Sie können 2 Start-Timer (ON1 und ON2) und 2 Stopp-Timer (OFF1 und OFF2) programmieren.

#### Programmierung des Timers 1 – Start

- 1) Drücken Sie auf  für 2s, der Timer ON1  blinkt (\*).
- 2) Drücken Sie auf . Stellen Sie die Stunden mit den Tasten   ein.
- 3) Drücken Sie auf . Stellen Sie die Minuten mit den Tasten   ein.
- 4) Drücken Sie auf  zur Bestätigung.



#### Abschalten des Timers 1 – Stopp

- 1) Drücken Sie auf  für 2s, der Timer ON1  blinkt (\*).  
Drücken Sie auf einmal , der Timer OFF1  blinkt.
- 2) Drücken Sie auf . Stellen Sie die Stunden mit den Tasten   ein.
- 3) Drücken Sie auf . Stellen Sie die Minuten mit den Tasten   ein.
- 4) Drücken Sie auf  zur Bestätigung.



(\*) Um direkt Timer ON2  aufzurufen, drücken Sie 2s lang auf  und drücken Sie dann 2 Mal auf .

## 4. BENUTZEROBERFLÄCHE (Fortsetzung)













### Abschalten des Timers 2

Nach den Einstellungen für Timer 1 gelangen Sie direkt zu den Einstellungen für Timer 2:  und .

Gehen Sie gleich vor wie bei Timer 1.

**Nota:** Um direkt Timer ON2  aufzurufen, drücken Sie 2s lang auf  und drücken Sie dann 2 Mal auf .

### Löschen der Timers (Start und Stopp)

- 1) Drücken Sie auf  für 2s, der Timer ON1  blinkt (\*)
- 2) Drücken Sie auf  , die Uhrzeitanzeige blinkt.
- 3) Drücken Sie auf  , um den Timer  zu löschen.
- 4) Drücken Sie auf  zur Bestätigung.
- 5) Drücken Sie auf  für 2s, der Timer ON1  blinkt.  
Drücken Sie 1 Mal auf  , der Timer  blinkt. (\*)
- 6) Drücken Sie auf  , die Uhrzeitanzeige blinkt.
- 7) Drücken Sie auf  , um den Timer  zu löschen.

(\*) Um direkt Timer2  oder  aufzurufen, befolgen Sie Schritt 1)- 4) und drücken Sie dann 2 Mal auf  . Gehen Sie gleich vor wie oben.

### 4.4 Wahl des Funktionsmodus: Kühlung, Heizung oder Auto Im Modus "OFF" oder "ON"

Drücken Sie auf  , um den Modus zu wechseln: Kühlung, Heizung oder Auto.

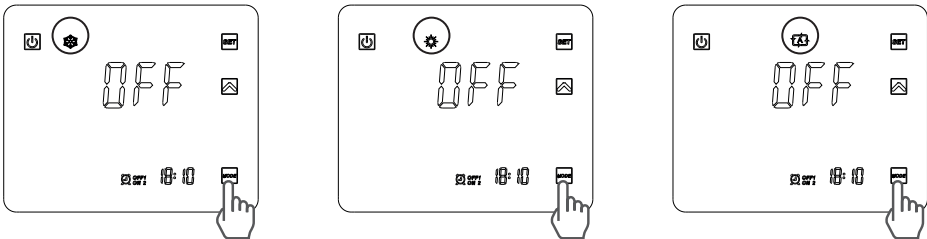



**Wenn die Wärmepumpe in nur Heizen oder nur Kühlen Modus eingestellt ist, ist die Modusänderung nicht möglich.**



## 4. BENUTZEROBERFLÄCHE (Fortsetzung)



### 4.5 Einstellung und Anzeige des Sollwerts (gewünschte Wassertemperatur)

Wenn die Taste  nicht auf dem Bildschirm angezeigt wird, drücken Sie kurz auf .

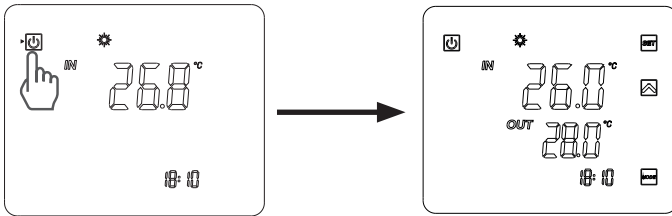
(Sowohl während des Betriebs als auch in ausgeschaltetem Zustand können Sie einfach auf die Taste  drücken, damit der Sollwert angezeigt wird.)





#### Im Modus "OFF" und im Modus "ON"



Drücken Sie die Knöpfe , damit der Sollwert angezeigt wird, und drücken Sie dann auf  oder  um den gewünschten Sollwert festzulegen. Die Einstellung erfolgt mit einer Präzision von 0,5 °C.



***Es wird empfohlen, niemals eine Temperatur von 30°C zu überschreiten, um Veränderungen der Auskleidungen zu vermeiden***

### 4.6 Sperren und Entsperren des Touchscreen

Drücken Sie 5 Sekunden lang den Knopf Start/Stop , bis Sie einen Piepton hören und die Symbole erscheinen .

Um den Touchscreen zu entsperren, drücken Sie  5 Sekunden lang den Knopf, bis Sie einen Piepton hören und die Symbole verschwinden .

## 4. BENUTZEROBERFLÄCHE (Fortsetzung)

### 4.7 Einstellen der SILENCE-Modus (🔇)

Mit dieser Funktion können die Ventilatoren der Wärmepumpe maximal 8 Stunden lang mit einer reduzierten Rotationsgeschwindigkeit von 600 U/min für das Modell ENP6MASC, 830 U/min für das Modell ENP6TASC und 800 U/min für das Modell ENP7TASC betrieben werden, um je nach Aufstellungsort der Wärmepumpe nachts und/oder tagsüber Lärmbelästigung der Nachbarn und/oder im Becken zu vermeiden.



Diese Funktion kann entweder manuell oder über eine Zeitschaltung Aktiviert/Deaktiviert werden.

#### Manuelle Aktivierung

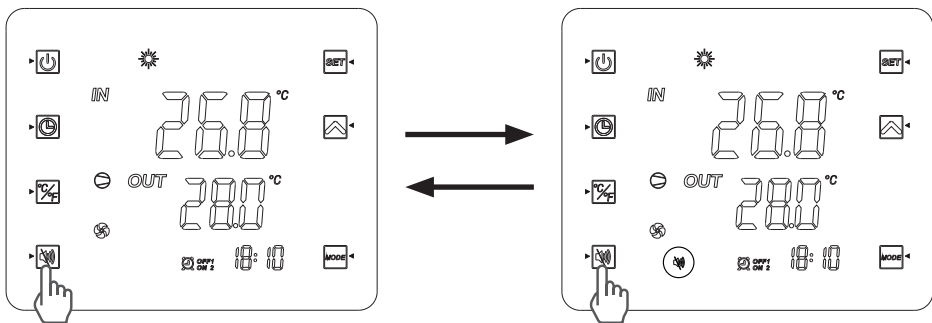
- 1) Drücken Sie die Taste .
- 2) Die nachfolgende Anzeige erscheint auf dem Bildschirm, der Ruhemodus ist für die folgenden 8 Stunden aktiviert.
- 3) Die Rotationsgeschwindigkeit der Ventilatoren wird schrittweise und für eine Dauer von maximal 8 Stunden herabgesetzt.
- 4) Nach 8 Stunden wird die Funktion automatisch deaktiviert und die Ventilatoren werden wieder mit einer an die Umgebungstemperatur angepassten Rotationsgeschwindigkeit betrieben.





#### Manuelle Deaktivierung

- 1) Drücken Sie die Taste .
- 2) Die Kontrollleuchte  verschwindet vom Bildschirm: Der Ruhemodus ist deaktiviert.
- 3) Die Ventilatoren passen ihre Rotationsgeschwindigkeit der Außenlufttemperatur an.

## 4. BENUTZEROBERFLÄCHE (Fortsetzung)



### Programmieren des RUHE-Modus

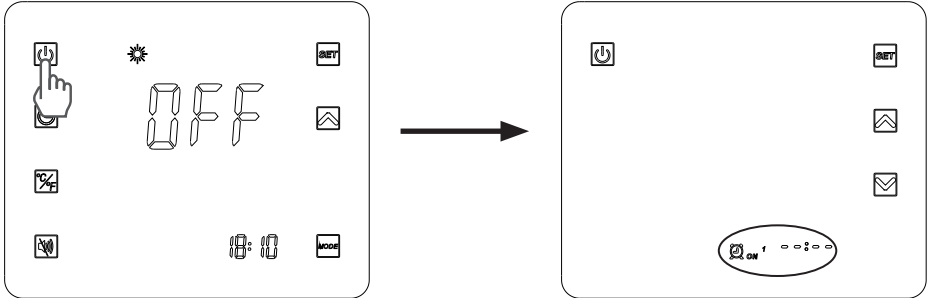

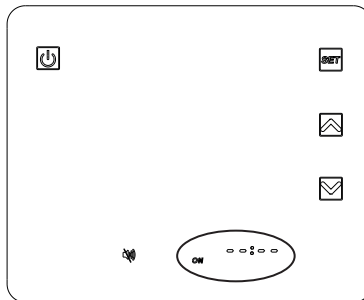

1) Drücken Sie auf  für 2s, der Timer ON1  blinkt.



2) Drücken Sie 4 Mal auf , bis der nachfolgende Bildschirm erscheint.



3) Drücken Sie auf , die Stundenanzeige blinkt. Stellen Sie mit den Pfeilen   die Stunden für die Startzeit ein.





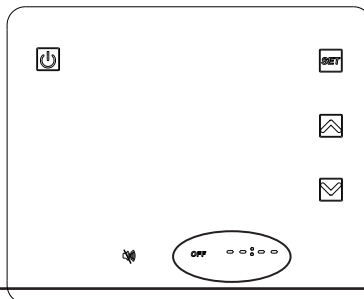



4) Drücken Sie auf , die Minutenanzeige blinkt. Stellen Sie mit den Pfeilen   die Minuten für die Startzeit ein.  
Drücken Sie zur Bestätigung auf .

5) Drücken Sie auf  um die Endzeit einzustellen: Die Anzeige OFF blinkt.



## 4. BENUTZEROBERFLÄCHE (Fortsetzung)

---

- 6) Drücken Sie auf , die Stundenanzeige blinkt. Stellen Sie mit den Pfeilen   die Stunden für die Endzeit ein.
- 7) Drücken Sie auf , die Minutenanzeige blinkt. Stellen Sie mit den Pfeilen   die Minuten für die Endzeit ein. Drücken Sie  zur Bestätigung auf.
- 8) Drücken Sie auf  um zum vorherigen Bildschirm zurückzukehren. Die Anzeigen ON/OFF erscheinen wie unten dargestellt.

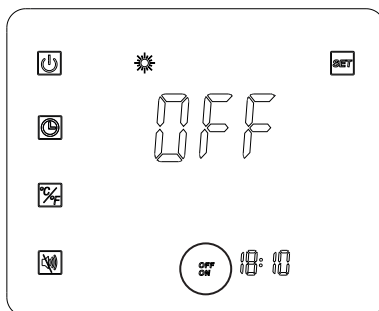

**Nota :** Die Einstellung der Minuten findet in Schritten von 10 Minuten statt.  
Nach erfolgter Einstellung des SILENCE-Modus ist dieser standardmäßig 7 Tage pro Woche aktiviert.

## 5. WARTUNG UND WINTERZEIT

---

### 5.1 Wartung

Diese Maßregeln zur Wartung müssen ein Mal pro Jahr durchgeführt werden, um die Langlebigkeit und gute Funktionsweise der Heizpumpenanlage zu garantieren.

- Reinigen Sie den Evaporator mit Hilfe einer flexiblen Bürste, einem Luft- oder einem Wasserstrahl (**Achtung: Verwenden Sie niemals einen Hochdruckreiniger**).
- Kontrollieren Sie den korrekten Abfluss des Kondensats.
- Kontrollieren Sie die hydraulischen und elektrischen Anschlüsse.
- Kontrollieren Sie die hydraulische Dichtigkeit des Kondensator.



***Vor allen Wartungsmaßnahmen muss die Heizpumpenanlage von jeglicher Stromversorgung getrennt werden. Die Wartungsmaßnahmen müssen von einem qualifizierten Fachmann durchgeführt werden, dem der Umgang mit Kühlfüssigkeiten vertraut ist.***

### 5.2 Winterzeit

- Stellen Sie die Heizpumpenanlage auf den Modus "OFF".
- Trennen Sie die Heizpumpenanlage von der Stromversorgung.
- Leeren Sie den Kondensator mit Hilfe des Wasserablassers, um jegliche Schadensgefahr zu vermeiden. (großes Frostrisiko).
- Schließen Sie den By-pass-Schieber und lösen Sie die Eingangs- und Ausgangsverbindungsstücke.
- Entfernen Sie so gut es geht das Altwasser im Kondensator mit Hilfe einer Druckluftpistole.
- Verschließen Sie den Wasserein- und -ausgang an der Heizpumpenanlage, um das Eindringen von Fremdkörpern zu verhindern.
- Decken Sie die Heizpumpenanlage mit der für diesen Zweck vorgesehenen Winterschutzhülle ab.



***Jeglicher Schaden, der durch eine schlechte Winterlagerung entsteht, hebt alle Garantieansprüche auf.***

# 6. ANHANG

## 6.1 Stromtafel

### ENP6MASC

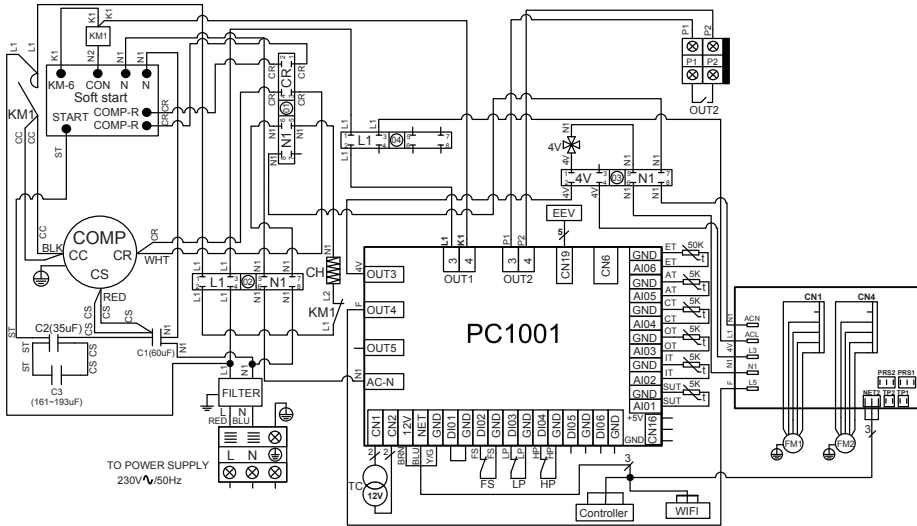

**ANMERKUNGEN:**

- 1. AT : AUSSENTEMPERSURSENSOR
- 2. COMP : KOMPRESSOR
- 3. CT : TEMPERSURSENSOR DES EVAPORATORS
- 4. EEV : ELEKTRONISCHER SENSOR
- 5. FM1-2 : GEBLÄSEMOTOR
- 6. FS : SENSOR DES WASSERSTANDES
- 7. HP : HOCHDRUCKREGLER
- 8. IT : SENSOR DER TEMPERSUR DES WASSEREINLASSES
- 9. LP : NIEDRIGDRUCKREGLER

- 10. OT : SENSOR DER TEMPERSUR DES WASSERAULASSES
- 11. SUT : SENSOR DER SAUGTEMPERSUR
- 12. TC : TRANSFORMATOR 230V~ / 12V~
- 13. 4V : 4-WEGE-VENTIL
- 14. KM1 : LEISTUNGSSCHÜTZ
- 15. SOFT START : ELEKTRONISCHER ANLASSER
- 16. CH : TRAGFÄHIGKEIT DES GEHÄUSES
- 17. OUT2 : POTENTIALFREIER TROCKENKONTAKT MAX. 7 A
- 18. ET : DRUCKTEMPERSURSONDE

# 6. ANHANG (Fortsetzung)

## ENP6TASC - ENP7TASC

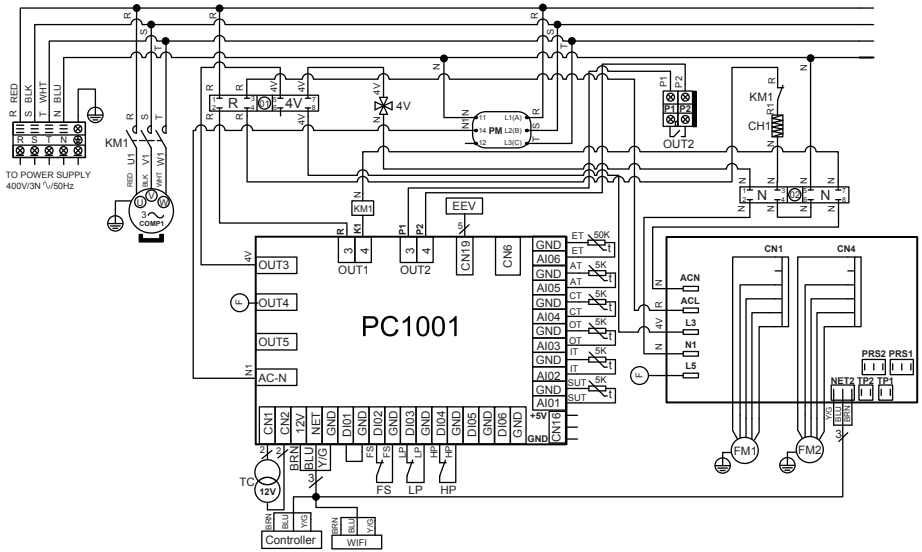

**ANMERKUNGEN:**

- |   |   |
|---|---|
| <ul style="list-style-type: none"> <li>1. AT : AUSSENTEMPATURSENSOR</li> <li>2. COMP : KOMPRESSOR</li> <li>3. CT : TEMPATURSENSOR DES EVAPORATORS</li> <li>4. EEV : ELEKTRONISCHER SENSOR</li> <li>5. FM1-2 : GEBLÄSEMOTOR</li> <li>6. FS : SENSOR DES WASSERSTANDES</li> <li>7. HP : HOCHDRUCKREGLER</li> <li>8. IT : SENSOR DER TEMPERATUR DES WASSEREINLASSES</li> <li>9. LP : NIEDRIGDRUCKREGLER</li> </ul> | <ul style="list-style-type: none"> <li>10. OT : SENSOR DER TEMPERATUR DES WASSERAUSLASSES</li> <li>11. SUT : SENSOR DER SAUGTEMPERATUR</li> <li>12. TC : TRANSFORMATOR 230V~/ 12V~/</li> <li>13. 4V : 4-WEGE-VENTIL</li> <li>14. KM1 : LEISTUNGSSCHÜTZ</li> <li>15. PM : PHASENWÄCHTER</li> <li>16 : CH1 : TRAGFÄHIGKEIT DES GEHÄUSES</li> <li>17. OUT2 : POTENTIALFREIER TROCKENKONTAKT MAX. 7 A</li> <li>18. ET : DRUCKTEMPERATURSONDE</li> </ul> |
|---|---|

## 6. ANHANG (Fortsetzung)

### 6.2 Vorrangige Heizanschlüsse einphasige Pumpe

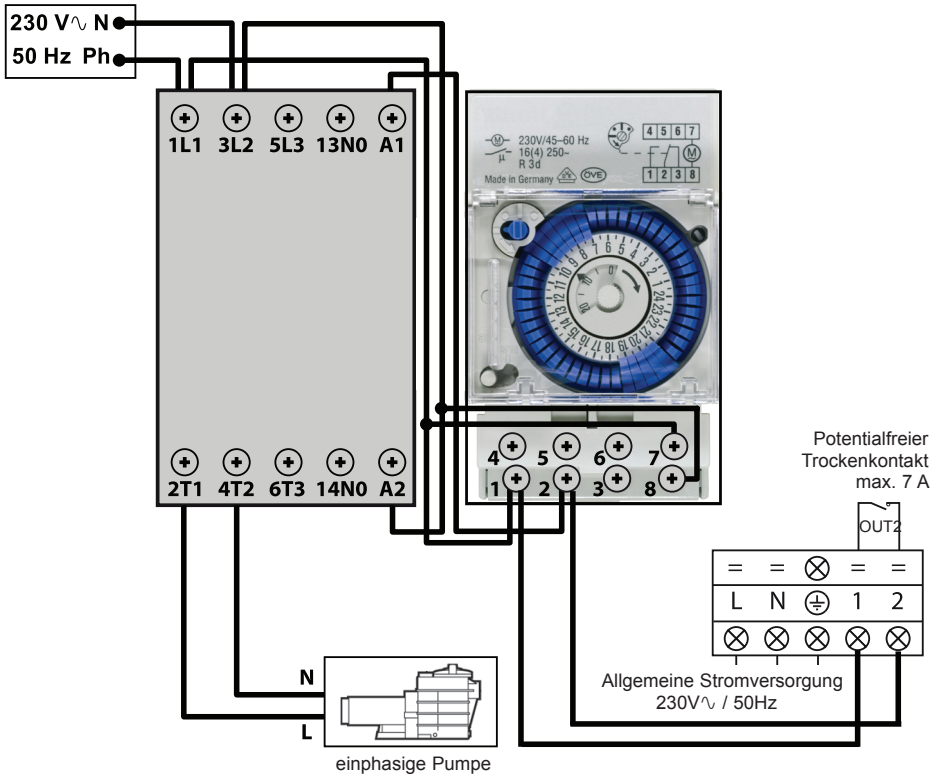

Die Anschlüsse 1 und 2 liefern einen potenzialfreien Trockenkontakt ohne Polarität 230 V  $\sim$  / 50 Hz. Verkabeln Sie die Anschlüsse 1 und 2 unter Berücksichtigung des folgenden Kabelschemas, um die Filtrationspumpe jede Stunde in einem 2-Minuten-Zyklus zu aktivieren, wenn die Temperatur des Beckens unter den Sollwert fällt.

 Die Stromversorgung der Filtrationspumpe niemals direkt an die Anschlüsse 1 und 2 anschließen.





# 6. ANHANG (Fortsetzung)

## 6.2 Vorrangige Heizanschlüsse dreiphasige Pumpe

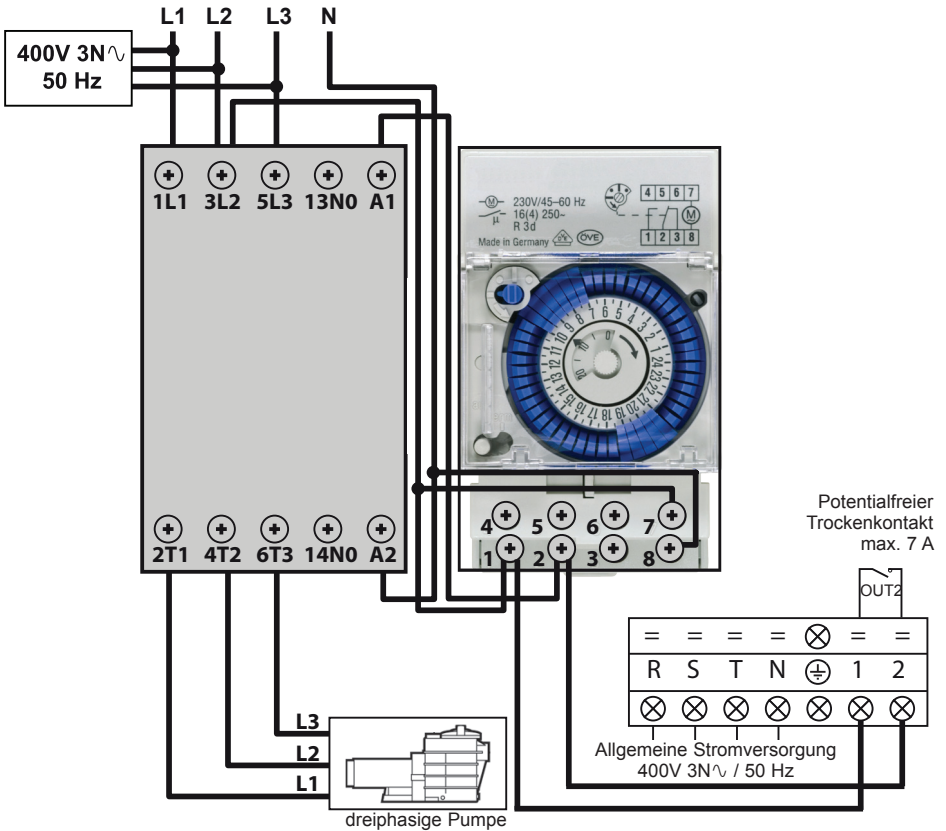

Die Anschlüsse 1 und 2 liefern einen potenzialfreien Trockenkontakt ohne Polarität 230 V $\sim$  / 50 Hz. Verkabeln Sie die Anschlüsse 1 und 2 unter Berücksichtigung des folgenden Kabelschemas, um die Filtrationspumpe jede Stunde in einem 2-Minuten-Zyklus zu aktivieren, wenn die Temperatur des Beckens unter den Sollwert fällt.



**!** Die Stromversorgung der Filtrationspumpe niemals direkt an die Anschlüsse 1 und 2 anschließen.

## 6. ANHANG (Fortsetzung)

### 6.3 Explosionszeichnungen und Einzelteile

#### ENP6MASC

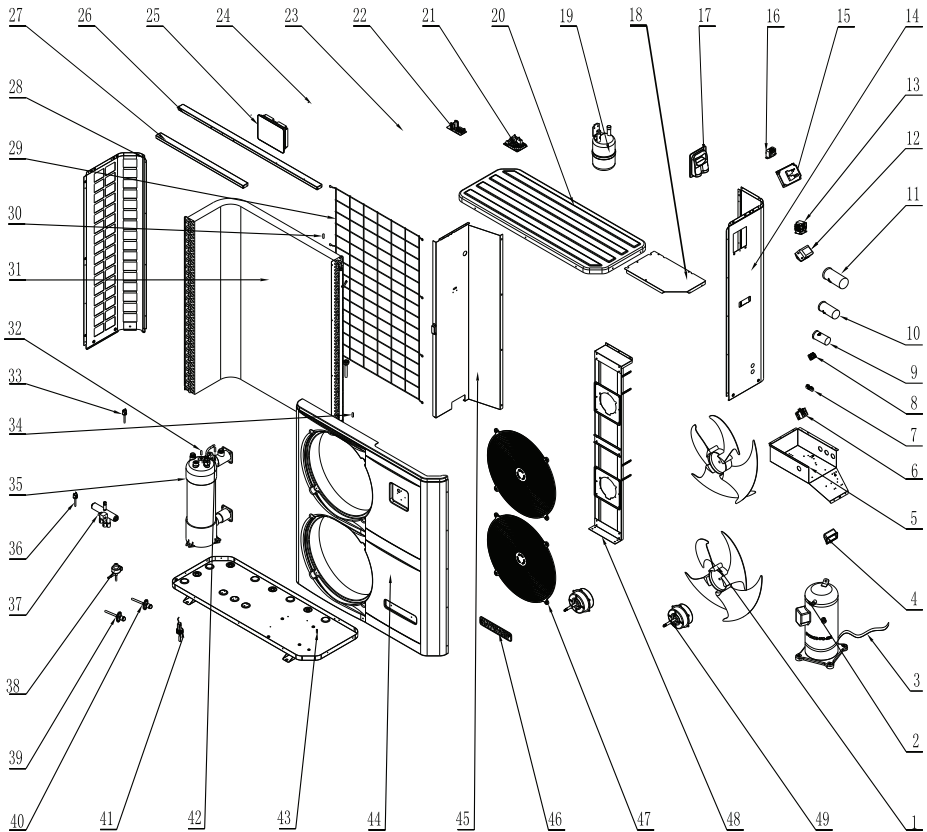

## 6. ANHANG (Fortsetzung)

### ENP6MASC

Rep	Réf.	Bezeichnung	Rep	Réf.	Bezeichnung
1	HWX20000270004	Gebälsepropeller	28	HWX32019210028	Linke Wand
2	HWX200011112	Kompressor	29	HWX32019210031	Schutzabdeckung für Verdampfer
3	HWX20003214	Kurbelgehäuseheizung	30	HWX20003242	Lufttemperatursensor
4	HWX32008220037	Griff	31	HWX32010120008	Verdampfer
5	HWX32019210040	Stromkasten	32	HWX20003242	Sensor des Wassereinlasses
6	HWX20003920	Klemmleiste mit 3 Anschlüssen	33	HWX20013605	Hochdruckregler
7	HWX20003909	Klemmleiste mit 2 Anschlüssen	34	HWX20003242	Temperatursensor des Evaporators
8	HWX20003933	Klemmleiste mit 3 Anschlüssen	35	HWX32010120023	Titan-Kondensator PVC
9	HWX20003504	Kondensator des Kompressors (35µF)	36	HWX20003603	Niedrigdruckregler
10	HWX20003510	Kondensator des Kompressors (60µF)	37	HWX20011491	4-Wege-Ventil
11	HWX20000350011	Startkondensator (193µF)	38	HWX20000140346	Elektronischer Sensor
12	HWX20003254	EMV-Filter	39	HWX20000140353	Druckabzweigung HD&ND
13	HWX200036007	Kompressorschütz mono	40	HWX20000140353	Druckabzweigung HD&ND
14	HWX32010210013	Rechte Platte	41	HWX200036005	Sensor des Wasserdurchsatzes
15	HWX20003151	Elektronischer Anlasser	42	HWX20003242	Sensor des Wasserauslasses
16	HWX200037003	Transformator 230V <sub>~</sub> - 12V <sub>~</sub>	43	HWX32019210061	Boden
17	HWX32009220032	Stromanschlussklappe	44	HWX32019210049	Vorderplatte
18	HWX32019210025	Stromschutzplatte	45	HWX32019210026	Trennplatte
19	HWX20001440	Flüssigkeitstank	46	HWX20000230596	Hayward-Logo
20	HWX32019220001	Obere Platte	47	HWX20000220169	Schutzgitter des Gebläses
21	HWX95053114512E	Elektronikkarte	48	HWX32019210022	Motorträger
22	HWX950531024103	DC-Wandler-Modul	49	HWX20000330132	DC-Motor
*23*	HWX20003223	Compressor-Sonde 50kΩ	*50*	HWX20002625	Schwingungsdämpfer
24	/	/	*51*	HWX200026009	O-Ring ID 43-SD 3,4 mm
25	HWX95005010018	LED-Regler	*52*	HWX200026061	O-Ring ID 48-SD 5 mm
26	HWX32019210030	Großes Aussteifungselement	*53*	HWX20000240112	Winterabdeckung
27	HWX32019210029	Kleines Aussteifungselement	*54*	HWX20001345	Ablasstopfen

Anmerkung: Die Markierungen \*xx\* sind nicht in der entsprechenden Explosionsdarstellung eingezeichnet.

## 6. ANHANG (Fortsetzung)

### ENP6TASC

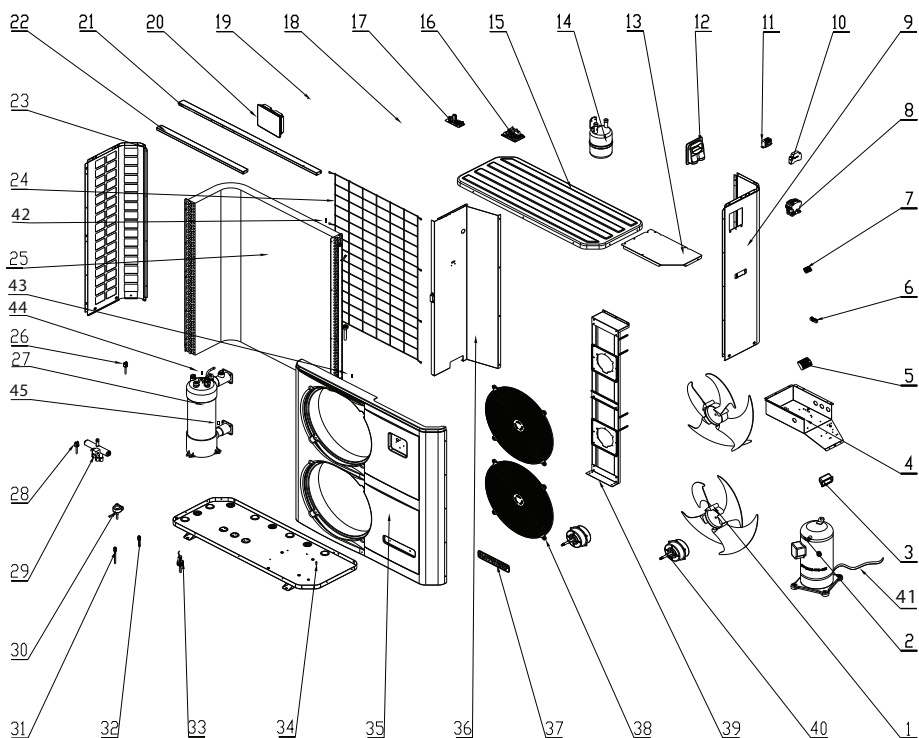

## 6. ANHANG (Fortsetzung)

### ENP6TASC

Rep	Réf.	Bezeichnung	Rep	Réf.	Bezeichnung
1	HWX20000270004	Gebläsepropeller	26	HWX20013605	Hochdruckregler
2	HWX20000110146	Kompressor	27	HWX32019120007	Titan-Kondensator PVC
3	HWX32008220037	Griff	28	HWX20003603	Niedrigdruckregler
4	HWX32019210024	Stromkasten	29	HWX20011491	4-Wege-Ventil
5	HWX20003902	Klemmleiste mit 5 Anschlüssen	30	HWX20000140346	Elektronischer Sensor
6	HWX20003909	Klemmleiste mit 2 Anschlüssen	31		
7	HWX20003933	Klemmleiste mit 3 Anschlüssen	32		
8	HWX20003653	Kompressorschütz TRI	33	HWX200036005	Sensor des Wasserdurchsatzes
9	HWX32019210027	Rechte Platte	34	HWX32019210061	Boden
10	HWX200036023	Phasenwächter	35	HWX32019210049	Vorderplatte
11	HWX200037003	Transformator 230V $\sqrt{2}$ -12V $\sqrt{2}$	36	HWX32019210026	Trennplatte
12	HWX32009220032	Stromanschlussklappe	37	HWX20000230596	Hayward-Logo
13	HWX32019210025	Stromschutzplatte	38	HWX20000220169	Schutzgitter des Gebläses
14	HWX20001440	Flüssigkeitstank	39	HWX32019210022	Motorträger
15	HWX32019220001	Obere Platte	40	HWX20000330132	DC-Motor
16	HWX95053114510E	Elektronikkarte	41	HWX20003214	Kurbelgehäuseheizung
17	HWX950531024101	DC-Wandler-Modul	42	HWX20003242	Sonde für Lufttemperatur
*18*	HWX20003223	Compressor-Sonde 50k $\Omega$	43		Temperatursensor des Evaporators
19	/	/	44		Sensor des Wassereinlasses
20	HWX95005010018	LED-Regler	45		Sensor des Wasserauslasses
21	HWX32019210030	Großes Aussteifungselement	*46*	HWX20002625	Schwingungsdämpfer
22	HWX32019210029	Kleines Aussteifungselement	*47*	HWX200026009	O-Ring ID 48-SD 5 mm
23	HWX32019210028	Linke Wand	*48*	HWX200026061	O-Ring ID 43-SD 3,4 mm
24	HWX32019210031	Schutzabdeckung für Verdampfer	*49*	HWX20000240112	Winterabdeckung
25	HWX32010120008	Verdampfer	*50*	HWX20001345	Ablasstopfen

Anmerkung: Die Markierungen \*xx\* sind nicht in der entsprechenden Explosionsdarstellung eingezeichnet.

## 6. ANHANG (Fortsetzung)

ENP7TASC

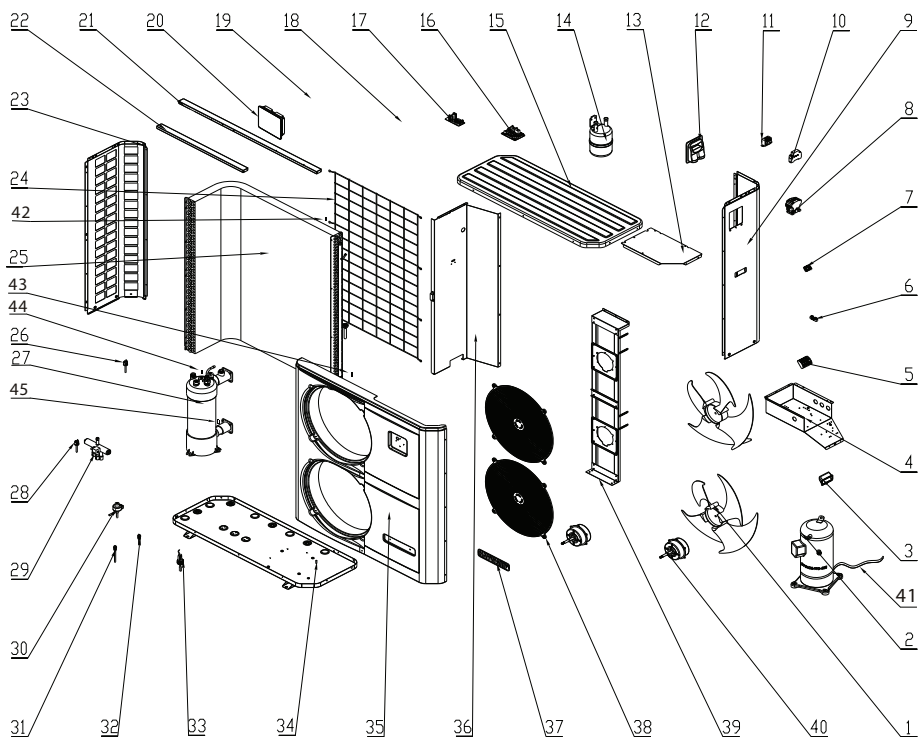

## 6. ANHANG (Fortsetzung)

### ENP7TASC

Rep	Réf.	Bezeichnung	Rep	Réf.	Bezeichnung
1	HWX20000270004	Gebläsepropeller	26	HWX20013605	Hochdruckregler
2	HWX20000110138	Kompressor	27	HWX32019120007	Titan-Kondensator PVC
3	HWX32008220037	Griff	28	HWX20003603	Niedrigdruckregler
4	HWX32019210024	Stromkasten	29	HWX20011491	4-Wege-Ventil
5	HWX20003902	Klemmleiste mit 5 Anschlüssen	30	HWX20000140398	Elektronischer Sensor
6	HWX20003909	Klemmleiste mit 2 Anschlüssen	31		
7	HWX20003933	Klemmleiste mit 3 Anschlüssen	32		
8	HWX20003653	Kompressorschütz TRI	33	HWX200036005	Sensor des Wasserdurchsatzes
9	HWX32019210027	Rechte Platte	34	HWX32019210061	Boden
10	HWX200036023	Phasenwächter	35	HWX32019210049	Vorderplatte
11	HWX200037003	Transformator 230V <sub>~</sub> -12V <sub>~</sub>	36	HWX32019210026	Trennplatte
12	HWX32009220032	Stromanschlussklappe	37	HWX20000230596	Hayward-Logo
13	HWX32019210025	Stromschutzplatte	38	HWX20000220169	Schutzgitter des Gebläses
14	HWX20001440	Flüssigkeitstank	39	HWX32019210022	Motorträger
15	HWX32019220001	Obere Platte	40	HWX20000330132	DC-Motor
16	HWX95053114511E	Elektronikkarte	41	HWX20003214	Kurbelgehäuseheizung
17	HWX950531024102	DC-Wandler-Modul	42	HWX20003242	Lufttemperatursensor
*18*	HWX20003223	Compressor-Sonde 50kΩ	43		Temperatursensor des Evaporators
19	/	/	44		Sensor des Wassereinlasses
20	HWX95005010018	LED-Regler	45		Sensor des Wasserauslasses
21	HWX32019210030	Großes Aussteifungselement	*46*	HWX20002625	Schwingungsdämpfer
22	HWX32019210029	Kleines Aussteifungselement	*47*	HWX200026009	O-Ring ID 48-SD 5 mm
23	HWX32019210028	Linke Wand	*48*	HWX200026061	O-Ring ID 43-SD 3,4 mm
24	HWX32019210031	Schutzabdeckung für Verdampfer	*49*	HWX20000240112	Winterabdeckung
25	HWX32019120002	Verdampfer	*50*	HWX20001345	Ablasstopfen

Anmerkung: Die Markierungen \*xx\* sind nicht in der entsprechenden Explosionsdarstellung eingezeichnet.

# 6. ANHANG (Fortsetzung)



## 6.4 Anleitung zur Fehlerbehebung

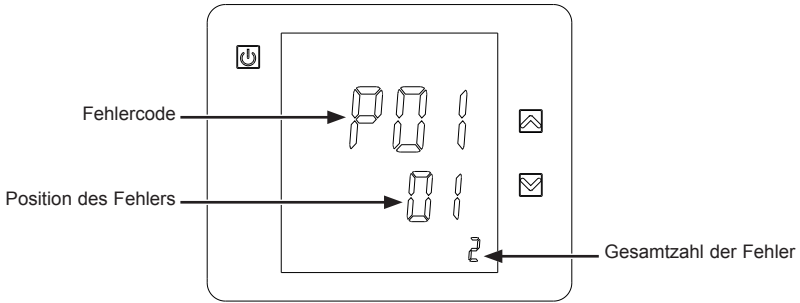

**Manche Maßnahmen müssen von einem mit der Anlage vertrauten Techniker durchgeführt werden.**

Im Falle einer Störung erscheinen die folgenden Anzeigen auf dem Bildschirm:



Sollten mehrere Störungen vorliegen, drücken Sie auf  oder , um durch die Fehlercodes zu navigieren. Siehe nachfolgende Tabelle.

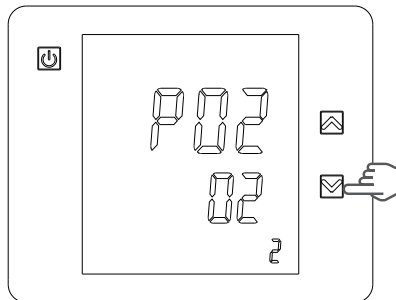



## 6. ANHANG (Fortsetzung)

Störung	Fehlercode	Beschreibung	Lösung
Ausfall des Sensors des Wassereinlasses	P01	Der Sensor ist offen oder hat einen Kurzschluss.	Überprüfen Sie den Sensor oder tauschen Sie ihn aus.
Ausfall des Sensors des Wasserauslasses	P02	Der Sensor ist offen oder hat einen Kurzschluss.	Überprüfen Sie den Sensor oder tauschen Sie ihn aus.
Ausfall des Magnetspulensensors	P05	Der Sensor ist offen oder hat einen Kurzschluss.	Überprüfen Sie den Sensor oder tauschen Sie ihn aus.
Ausfall des Außentemperatursensors	P04	Der Sensor ist offen oder hat einen Kurzschluss.	Überprüfen Sie den Sensor oder tauschen Sie ihn aus.
Fehler an der Saugsonde des Kompressors	P07	Der Sensor ist offen oder hat einen Kurzschluss.	Überprüfen Sie den Sensor oder tauschen Sie ihn aus.
Temperaturunterschied zwischen Wasserein- und Wasserauslass ist zu groß	E06	Nicht ausreichendes Volumen des Wasserdurchsatzes, Wasserdifferenz ist zu klein / zu groß.	Überprüfen Sie den Wasserdurchsatz bzw. eine mögliche Verstopfung des Systems.
Frostschutz Frostmodus	E07	Zu geringer Wasserauslass	Überprüfen Sie den Wasserdurchsatz bzw. den Temperatursensor des Wasserauslasses
Frostschutz auf Niveau 1	E19	Außen- oder Wassereinlasstemperatur zu niedrig	
Frostschutz auf Niveau 2	E29	Außen- oder Wassereinlasstemperatur noch immer zu niedrig.	
Hochdruckregler	E01	Der Druck des Kühlkreislaufs ist zu hoch bzw. der Wasserdurchsatz zu gering bzw. der Luftdurchsatz ist zu gering.	Überprüfen Sie den Hochdruckregler und den Druck des Kühlkreislaufs. Überprüfen Sie den Wasser- oder Luftdurchsatz. Überprüfen Sie die Funktion der Durchflusskontrolle. Überprüfen Sie die Öffnung des Wassereingang-/ausgangsschiebers. Überprüfen Sie die Regulierung des By-pass.
Niederdruckregler	E02	Der Druck des Kühlkreislaufs ist zu schwach bzw. der Luftdurchsatz ist zu schwach bzw. der Evaporator ist verstopft.	Überprüfen Sie den Niederdruckregler und den Druck des Kühlkreislaufs, um zu überprüfen, ob es eine undichte Stelle gibt. Reinigen Sie die Oberfläche des Evaporators. Überprüfen Sie die Rotationsgeschwindigkeit des Gebläses. Überprüfen Sie die freie Luftzirkulation mit Hilfe des Evaporators.
Ausfall des Durchsatzsensors	E03	Wasserdurchsatz unzureichend bzw. Fehler oder Kurzschluss des Sensors	Überprüfen Sie den Wasserdurchsatz, überprüfen Sie die Filterpumpe und den Durchsatzsensor, um festzustellen, ob eventuell eine Störung vorliegt.
Kommunikationsproblem	E08	Ausfall der LED-Steuerung oder des PCB-Anschlusses.	Überprüfen Sie die Verbindung der Kabel NET und NET 1.
Der Kompressor läuft nicht an	E08	Phasenausfall oder falsche Phasenfolge	das Vorhandensein aller 3 Phasen kontrollieren die Reihenfolge der Phasen auf der Anschlussklemme der Wärmepumpe ändern

## 6. ANHANG (Fortsetzung)

---

### 6.5 Garantie

#### **GARANTIE BEDINGUNGEN**

HAYWARD Produkte unterliegt einer Garantie auf Material und Verarbeitungsfehler von zwei Jahren, gerechnet ab dem Versanddatum. Zur besseren Kontrolle dieses Datums bitten wir Sie daher, Ihre Rechnung aufzubewahren.

Die HAYWARD Garantie beschränkt sich auf den kostenlosen Austausch oder die Reparatur des in Frage kommenden Produktes. Die Entscheidung hierüber obliegt uns, und berücksichtigt u.a. einen normalen Gebrauch des Produktes, gemäß den Gebrauchshinweisen. Es darf kein Teil des Produktes ausgetauscht werden und zum Betrieb dürfen ausschließlich Teile von HAYWARD verwendet werden.

Frostschäden und Schäden durch chemische Produkte sind von der Garantie ausgeschlossen.

Darüber hinaus übernimmt HAYWARD keine Kosten die direkt oder indirekt durch den eventuellen Fehler eines Produktes aufgetreten sind (Ausbau, Transport, u.s.w....)

Um eine Garantie anzumelden wenden Sie sich bitte an Ihren Schwimmbadhändler. Aus organisatorischen Gründen können wir eine unerlaubt an uns geschicktes Teil nicht bearbeiten.

Verschleißteile sind von der Garantie ausgeschlossen.

ISENPASC Rev C

# ***ENERGYLINE PRO***

**ZWEMBAD WARMTEPOMP**



**Installatie- en bedieningshandleiding**

# INHOUD

---

<b>1. Voorwoord</b>	<b>1</b>
<hr/>	
<b>2. Technische specificaties</b>	<b>2</b>
2.1 Technische gegevens over de warmtepomp	2
2.2 Werkgebied	3
2.3 Afmetingen	4
<hr/>	
<b>3. Installatie en aansluiting</b>	<b>5</b>
3.1 Basisschema	5
3.2 Warmtepomp	6
3.3 Hydraulische aansluiting	6
3.4 Elektrische aansluiting	7
3.5 Eerste gebruik	8
3.6 Instelling van het waterdebiet	10
<hr/>	
<b>4. Gebruikers interface</b>	<b>11</b>
4.1 Algemende voorstelling	11
4.2 De klok instellen	13
4.3 De tuner instellen	13
4.4 Gebruiksmodus	14
4.5 Instelbereik en visualisatie van de gewenste waarde	15
4.6 Het toetsenbord vergrendelen en ontgrendelen	15
4.7 Instelling van de silence modus	16
<hr/>	
<b>5. Onderhoud en Overwintering</b>	<b>19</b>
5.1 Onderhoud	19
5.2 Overwintering	19
<hr/>	
<b>6. Bijlagen</b>	<b>20</b>
6.1 Elektrische schema's	20
6.2 Aansluitingen verwarmingsprioriteit	22
6.3 Opengewerkte tekeningen en onderdelen	24
6.4 Gids voor probleemoplossing	30
6.5 Garantie	32

Aandachtig lezen en bewaren voor later gebruik.

Dit document moet aan de eigenaar van het zwebad overhandigd en door hem op een veilige plaats bewaard worden.

# 1. VOORWOORD

---

Wij danken u voor uw aankoop van deze zwembad Hayward warmtepomp. Dit product werd volgens de stricte productienormen gefabriceerd om aan de vereiste kwaliteitsnormen te voldoen. Deze handleiding bevat alle noodzakelijke informatie voor de installatie, het oplossen van problemen en het onderhoud. Gelieve deze handleiding aandachtig te lezen alvorens de eenheid te openen of te onderhouden. De fabrikant van dit product kan niet verantwoordelijk worden gesteld in geval van kwetsuren of schade aan de eenheid als gevolg van eventuele fouten tijdens de installatie, het oplossen van problemen of een onnodig onderhoud. Het is uiterst belangrijk dat de instructies in deze handleiding ten aller tijde nageleefd worden. De eenheid moet door een bevoegd persoon geïnstalleerd worden.

- De eenheid moet door een bevoegd persoon hersteld worden.
- Alle elektrische aansluitingen moeten door een erkende, professionele elektricien uitgevoerd worden en volgens de geldende normen in het land van installatie cf § 3.4.
- Het onderhoud en de bediening dient uitgevoerd te worden volgens de in deze handleiding opgegeven aanbevolen tijden en frekwenties.
- Gebruik uitsluitend originele wisselstukken.
- Het niet naleven van deze aanbevelingen heeft het verlies van de garantie tot gevolg.
- Deze warmtepomp verwarmt het zwembadwater en houdt de temperatuur constant. Gebruik hem niet voor andere doeleinden.

Nadat u deze handleiding gelezen hebt, bewaar deze dan voor eventueel later gebruik.

Waarschuwingen betreffende kinderen/ personen met een fysieke beperking: Dit product is niet bedoeld voor gebruik door personen (waaronder kinderen) met een fysieke, zintuigelijke of mentale beperking, voor onervaren personen of personen zonder voorkennis, tenzij onder toezicht of wanneer zij instructies krijgen over de installatie van iemand die instaat voor hun veiligheid.

Dit product bevat gefluoreerde broeikasgassen vastgelegd door het Kyoto-protocol.

Koelmiddel : R410A

GWP-waarde<sup>(1)</sup>: 1975

Afhankelijk van de Europese of lokale wetgeving, moet regelmatig op koelmiddellekken gecontroleerd worden. Gelieve uw plaatselijke distributeur te contacteren voor meer informatie.

---

(1) Aardopwarmingspotentieel

## 2. TECHNISCHE EIGENSCHAPPEN

---

### 2.1 Technische gegevens over de warmtepomp

Modellen	ENERGYLINE PRO	ENP6MASC	ENP6TASC	ENP7TASC
Verwarmingcapaciteit *	kW	17,8	18,2	23,4
Energieverbruik *	kW	3,69	3,7	5,15
Elektriciteitsvermogen *	A	16,2	7,69 / 6,89 / 6,33	9,71 / 8,01 / 7,70
Voedingsspanning	V Ph/Hz	230V~ 50Hz	400V 3N~ 50Hz	400V 3N~ 50Hz
Smeltzekering type aM	A	20	12	16
Stroomonderbreker met D-curve	A	20	12	16
Aantal compressoren		1	1	1
Compressor type		Scroll	Scroll	Scroll
Aantal ventilatoren		2	2	2
Ventilatorvermogen	W	50 — 225	50 — 225	50 — 225
Rotatiesnelheid van de ventilatoren	RPM	600 — 950	830 — 960	800 — 1050
Ventilatie		Horizontaal	Horizontaal	Horizontaal
Geluidsdruk niveau (op 1 meter afstand)	dB(A)	45	45	47
Hydraulische aansluiting	mm	50	50	50
Nominaal waterverbruik*	m <sup>3</sup> /h	6,6	6,6	8
Waterdrukverlies (max)	kPa	7	7	18
Nettoafmetingen van de eenheid (L/B/H)	mm	1138 / 470 / 1264	1138 / 470 / 1264	1138 / 470 / 1264
Nettogewicht van de eenheid	kg	127	123	140



\* Waarde +/- 5% onder de volgende voorwaarden: Buitentemperatuur = 15°C (59°F) / HR = 71% /  
Temperatuur binnenkomend water = 26°C (78,8°F).  
Conform de referentie NF-414 (jaarlijks gebruik)

## 2. TECHNISCHE EIGENSCHAPPEN (vervolg)

---

### 2.2 Werkgebied

Gebruik de warmtepomp in volgende temperatuur- en vochtigheidsbereiken om een correct en efficiënt te garanderen.

	Verwarmingsmodus 	Afkoelingsmodus 
Buitempreatuur	-12°C ~ +35°C	+7°C ~ +43°C
Watertemperatuur	+12°C ~ +40°C	+8°C ~ +40°C
Relatieve vochtigheid	< 80%	< 80%
Instelbereik van de gewenste waarde	+15°C ~ +32°C	+8°C ~ +32°C



***Als de temperatuur of de vochtigheid niet aan deze voorwaarden voldoet, kunnen beveiligingen losraken en kan de warmtepomp niet meer werken.***



***De maximale verwarmingstemperatuur is 32°C om beschadiging van de liners te voorkomen. Hayward wijst alle aansprakelijkheid af in geval van gebruik boven 32°C.***

## 2. TECHNISCHE EIGENSCHAPPEN (vervolg)

### 2.3 Afmetingen

Modellen : ENP6MASC / ENP6TASC / ENP7TASC

Eenheid : mm

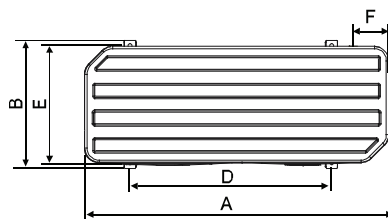
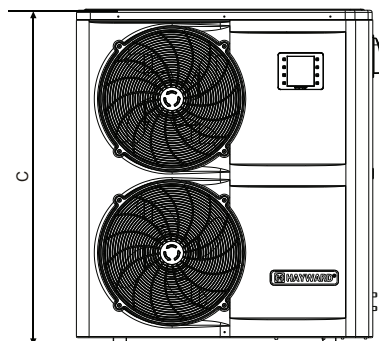
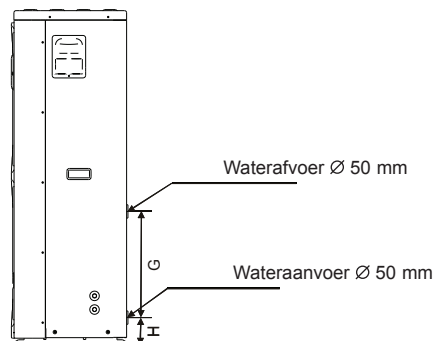

TYPE SIZE (mm)	ENP6MASC	ENP6TASC ENP7TASC
A	1138	1138
B	470	470
C	1264	1264
D	790	790
E	447	447
F	114	114
G	500	400
H	104	104



### 3. INSTALLATIE EN AANSLUITING

#### 3.1 Basisschema

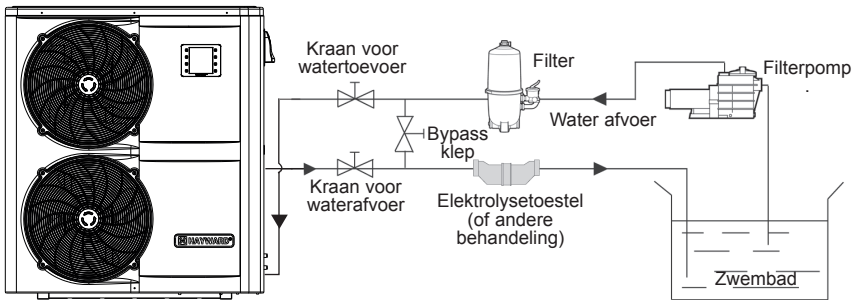

Opmerking : Met de warmtepomp wordt geen randapparatuur of filter meegeleverd. De onderdelen op het schema moeten door de installateur voorzien worden.

#### 3.2 Warmtepomp



***Plaats de pomp en openlucht en buiten een gesloten technisch locaal.***

***De installatie moet beschut staan en de hieronder voorgeschreven minimumafstanden moeten gerespecteerd worden om luchtterugvoer en een minder goede werking van de warmtepomp te voorkomen***

Unit: mm

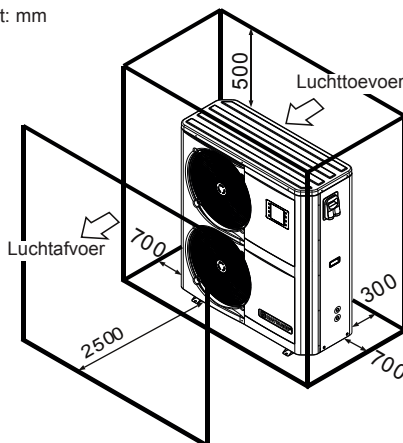

## 3. INSTALLATIE EN AANSLUITING (vervolg)

---



*Installeer de warmtepomp bij voorkeur op een betonplaat of een bevestigingsstoel die voor dit doeleinde voorzien is en installeer de warmtepomp op de voorziene silentblokken (schroeven en rondellen niet meegeleverd).*

*De maximumafstand tussen de warmtepomp en het zwembad is 15 meter.*

*De totale lengte van de hydraulische leidingen is 30 meter.*

*De bovengrondse en ondergrondse hydraulische kanalen isoleren.*

### 3.3 Hydraulische aansluiting

De warmtepomp is voorzien van 2 aansluitingen met een diameter van 50 mm. Gebruik PVC-buizen voor de hydraulische leidingen Ø 50 mm. Sluit de watertoevoer van de warmtepomp op de leiding die van de filtergroep komt en sluit daarna de waterafvoer van de warmtepomp op de waterleiding die naar het zwembad loopt (cv tekening hieronder).

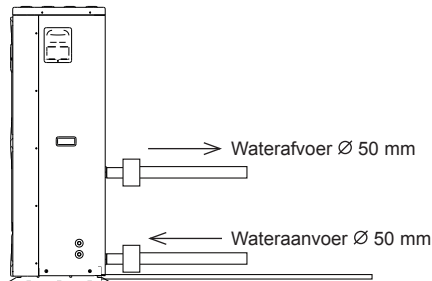

Installeer een bypassklep tussen de in- en uitgang van de warmtepomp.



*Als u een automatische distributeur of een elektrolyseapparaat gebruikt, moet deze na de warmtepomp geïnstalleerd worden om de Titanium condensor tegen een te hoge concentratie aan chemische producten te beschermen.*



*Zorg ervoor dat de bypassklep en de aansluitingen op de aan- en afvoer van het water goed geïnstalleerd zijn om de drainage tijdens de winterperiode, de toegang en de demontage voor onderhoud te vergemakkelijken.*

### 3. INSTALLATIE EN AANSLUITING (vervolg)

#### 3.4 Elektrische aansluiting



**De elektrische installatie en de bekabeling van deze uitrusting moeten conform zijn met de plaatselijk geldende normen.**

F	NF C15-100	GB	BS7671:1992
D	DIN VDE 0100-702	EW	EVHS-HD 384-7-702
A	ÖVE 8001-4-702	H	MSZ 2364-702/1994/MSZ 10-553 1/1990
E	UNE 20460-7-702 1993, RECBT ITC-BT-31 2002	M	MSA HD 384-7-702.S2
IRL	Wiring Rules + IS HD 384-7-702	PL	PN-IEC 60364-7-702:1999
I	CEI 64-8/7	CZ	CSN 33 2000 7-702
LUX	384-7.702 S2	SK	STN 33 2000-7-702
NL	NEN 1010-7-702	SLO	SIST HD 384-7-702.S2
P	RSIUEE	TR	TS IEC 60364-7-702



**Controleer of de elektrische voeding en de netwerkfrequentie overeenstemmen met de vereiste werkstroom, door rekening te houden met de specifieke plaatsing van het toestel en de noodzakelijke stroom om alle andere toestellen die op hetzelfde circuit aangesloten zijn, te voeden.**

**ENP6MASC 230 V $\sim$  +/- 10 % 50 Hz 1 Phase**

**ENP6TASC 400 V $\sim$  +/- 10 % 50 Hz 3 Phases**

**ENP7TASC 400 V $\sim$  +/- 10 % 50 Hz 3 Phases**



**Controleer of het fasenevenwicht niet meer dan 2% bedraagt**

**Bestudeer het overeenkomstige bedradingsschema in bijlage.**

**De aansluitdoos bevindt zich aan de rechterkant van de eenheid. Drie connecties zijn voor de elektrische voeding en twee voor de besturing van de warmtepomp (Bediening).**

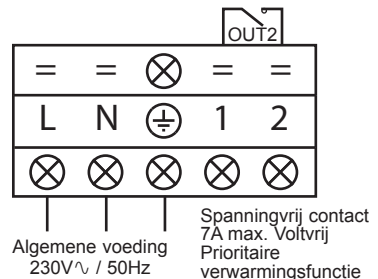
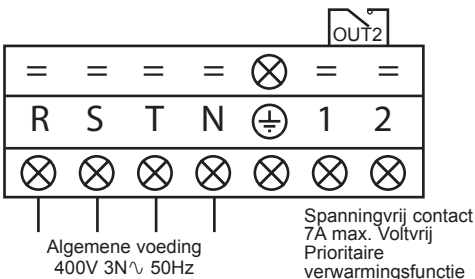

### 3. INSTALLATIE EN AANSLUITING (vervolg)

---



**De elektrische voedingskabel moet, op gepaste manier, voorzien zijn van een beveiligingszekering van het type motorvoeding (aM) of een stroomonderbreker met D-curve en een diferentieelschakelaar 30mA (zie tabel hieronder).**

Modellen		ENP6MASC	ENP6TASC	ENP7TASC
Elektrische voeding	V/Ph/Hz	230V $\sim$ 50Hz	400V 3N $\sim$ 50Hz	400V 3N $\sim$ 50Hz
Smeltzekering type aM	A	20 aM	12 aM	16 aM
Stroomonderbreker met D-curve	A	20 D	12 D	16 D
Kabelsectie	mm <sup>2</sup>	3G6 3 x 6	5G2,5 5 x 2,5	5G2,5 5 x 2,5



**Gebruik een voedingskabel van het type RO 2V / R 2V of equivalent.**



**De kabelsecties worden gegeven voor een maximale lengte van 25 m. Deze moeten echter worden gecontroleerd en aangepast afhankelijk van de installatieomstandigheden.**



**Schakel altijd de hoofdschakelaar uit alvorens de elektriciteitsdoos te openen.**

#### 3.5 Eerste gebruik

Opstartprocedure - zodra de installatie beëindigd is, moet u de volgende stappen volgen en respecteren :

- 1) Draai de ventilatoren handmatig om te controleren of deze met de hand gedraaid kunnen worden en of het blad op de motorboom bevestigd is.
- 2) Controleer of de eenheid correct op de hoofdvoeding aangesloten is (zie bedradingsschema in bijlage).
- 3) Activeer de filterpomp.
- 4) Controleer of alle waterkleppen openstaan en dat het water naar de eenheid loopt alvorens in verwarming of koeling opstart.
- 5) Controleer of de drainageleiding correct vastgemaakt is en niet verstopt is.
- 6) Schakel de elektrische voeding van de eenheid in en druk daarna op de Start/Stop-knop  op het controlepaneel.

### 3. INSTALLATIE EN AANSLUITING (vervolg)

---

- 7) Controleer of er geen enkele ALARM-code wordt weergegeven wanneer de eenheid op ON staat (zie gids voor probleemoplossing).
- 8) Leg het waterdebiet vast met behulp van de bypassklep (zie § 3.6 en 2.1), zoals respectievelijk vastgelegd is voor ieder model, zodat er een temperatuurverschil van 2°C is tussen het Binnenkomend en Uitgaand water.
- 9) Wanneer het toestel enkele minuten gedraaid heeft, controleer dan dat de lucht die eruit komt, afgekoeld is (tussen 5° en 10°).
- 10) Stop de filterpomp terwijl de eenheid blijft draaien. De eenheid moet automatisch stoppen en de foutcode E03 weergeven.
- 11) Laat de eenheid en de zwembadpomp 24u op 24u draaien todat de gewenste watertemperatuur bereikt is. Wanneer het binnenkomend water de gewenste temperatuur bereikt heeft, zal de eenheid stilvallen. Ze zal automatisch opstarten (als de zwembadpomp in werking is) als de temperatuur van het zwembad 0.5°C lager is dan de gewenste temperatuur.

**Debietschakelaar** - De eenheid is voorzien van een debietschakelaar die de warmtepomp inschakelt wanneer de filterpomp van het zwembad in werking is, en uitschakelt wanneer de de filterpomp stopt. Bij onvoldoende water zal de alarmcode E03 op de schakelaar getoond worden (Zie § 6.4).

**Vertraging** - De eenheid vertoont een vertraging van 3 minuten om de onderdelen van het besturingscircuit te beschermen en om onregelmatige opstart en storingen van de contactor te vermijden. Dankzij deze vertraging start de eenheid automatisch op ongeveer 3 minuten na een stroomonderbreking. Zelfs een korte stroomonderbreking zal de uitgestelde start activeren.

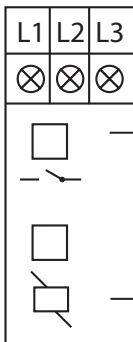

**Faseregelaar** - De driefasenunits zijn voorzien van een faseregelaar om de correcte draairichting van de compressor te garanderen.

Controleer, als de unit niet opstart, de staat van de faseregelaar in het elektrische kastje.

Geel /oranje AAN = Relais ON = Fasevolgorde en Aantal fasen OK

Groen = Ingeschakeld

### 3. INSTALLATIE EN AANSLUITING (vervolg)

---

#### 3.6 Instelling van het waterdebiet

Terwijl de kleppen voor binnenkomend en uitgaand water openstaan, moet u de bypassklep afstellen om een temperatuurverschil van 2°C tussen het binnenkomend en uitgaand water te bekomen (zie basisschema §3.1). U kan de instelling controleren voor de temperaturen van het binnenkomend en uitgaand water te visualiseren op het controlepaneel.

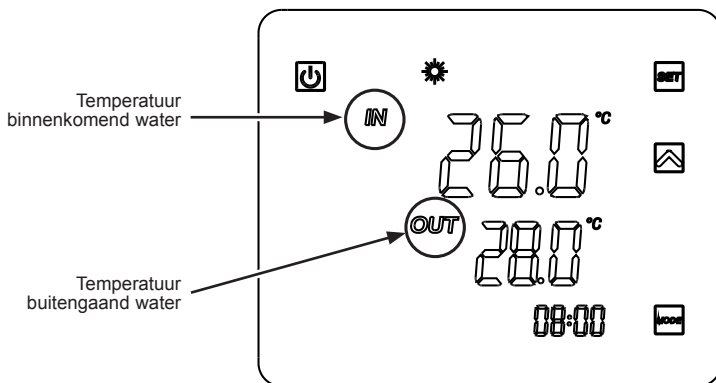

Opmerking : De opening van de bypassklep zorgt voor een lager waterdebiet.  
De sluiting van de bypassklep zorgt voor een hoger waterdebiet.

# 4. GEBRUIKERSINTERFACE

## 4.1 Algemene voorstelling

De warmtepomp is uitgerust met een digitaal besturingspaneel met touchscreen, elektrisch aangesloten en voorgeïnstalleerd in verwarmingsmodus.

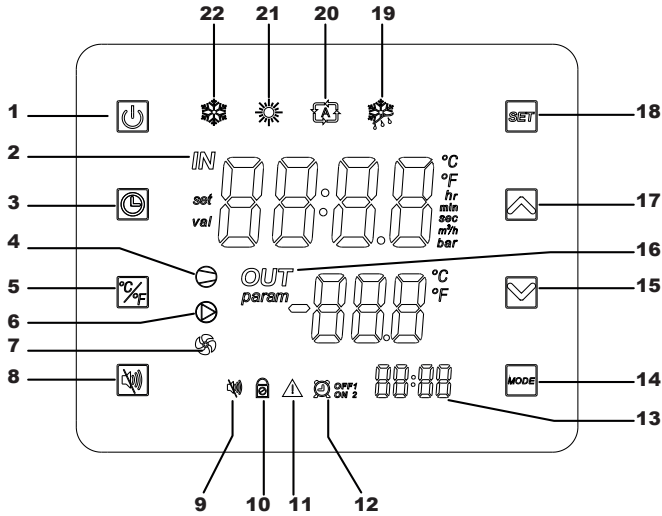

### Legende

1		Start/Stop
2	IN	Binnenkomend water
3		Instelling uur en Timer
4		Compressor ON
5		Conversie °C/°F
6		Drog contact OUT2
7		Fan ON
8		Stille modus
9		Verklikkerlampje stille modus
10		Scherm vergrendeld
11		Alarm

12		Timers 1 en 2
13		Tijd van de timers
14	MODE	Kiezen van de modus
15		Schuifbalk onderaan / Verlagen
16	OUT	Buitengaand water
17		Schuifbalk bovenaan / Verhogen
18	SET	Opslaan/Instellingen
19		Modus de-icing
20		Automatische modus
21		Verwarmingsmodus
22		Afkoelingsmodus

## 4. GEBRUIKERSINTERFACE (vervolg)

---

### Modus OFF

Wanneer de warmtepomp in slaapstand staat (Modus OFF), kan u "OFF" op het scherm van de schakelaar aflezen.

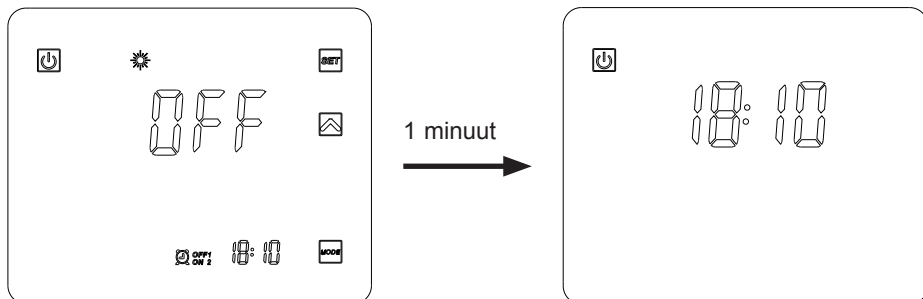

### Modus ON

Wanneer de warmtepomp in werking of in gebruik is (Modus ON), zijn de inkomende en uitgaande watertemperaturen op het scherm van de schakelaar af te lezen.

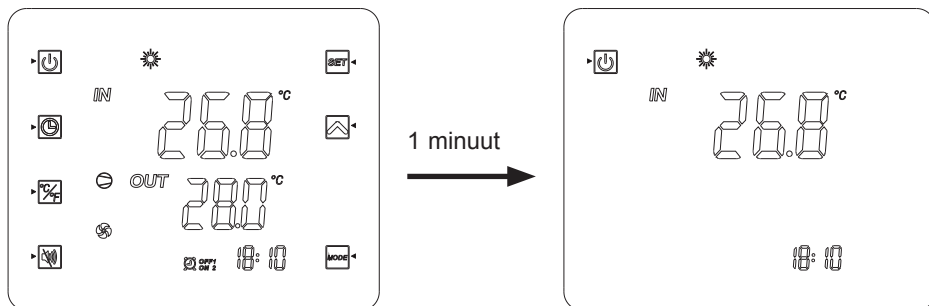









## 4. GEBRUIKERSINTERFACE (vervolg)

Aan het einde van de instellingen op  te bevestigen.  
Instellingen de opname automatisch na '20 zonder actie.

### 4.2 De klok instellen

Als de weergave in de slaapmodus staat, drukt u kort op knop .



- 1) Druk op  voor weergave van het symbool .
- 2) Druk op , de tijdweergave knippert. Stel de uren in met behulp van de knoppen  .
- 3) Druk op  en stel de minuten in met behulp van de knoppen  .
- 4) Valideer door te drukken op .

### 4.3 De Timer instellen











De instellingen van deze functie zijn noodzakelijk zodra u uw warmtepomp binnen een kortere termijn dan vastgelegd door de filterklok wilt gebruiken. Op die manier kunt u een uitgestelde start en een vroegtijdige uitschakeling programmeren of eenvoudigweg een periode waarin de pomp niet gebruikt mag worden.



U kunt 2 Timers Start (ON1 en ON2) en 2 Timers Stop (OFF1 en OFF2) programmeren.

#### Programmeren Timer 1 – Starttijd

- 1) Druk 2 s op , de Timer ON1  knippert (\*).
- 2) Druk op  om de uren in te stellen met behulp van de knoppen  .
- 3) Druk op  om de minuten in te stellen met behulp van de knoppen  .
- 4) Valideer door te drukken op .

#### Programmeren Timer 1 – Stoptijd

- 1) Druk 2 s op , de Timer ON1  knippert (\*).  
Druk 1 keer op , de Timer OFF1  knippert.
- 2) Druk op  om de uren in te stellen met behulp van de knoppen  .
- 3) Druk op  om de minuten in te stellen met behulp van de knoppen  .
- 4) Valideer door te drukken op .

(\* Om direct naar Timer ON2 , drukt u 2 s op  en vervolgens 2 keer op .

## 4. GEBRUIKERSINTERFACE (vervolg)

### Programmeren Timer 2

















Na het instellen van Timer 1, gaat u direct naar de instellingen van Timer 2:

 en .

Volg de dezelfde stappen als voor instelling van Timer 1.

**Nota:** Om direct naar Timer ON2 , drukt u 2 s op  en vervolgens 2 keer op .

### Verwijderen van de Timers (Start en Stop)

- 1) Druk 2 s op , de Timer ON1  knippert. (\*)
  - 2) Druk op , de weergave van de uren knippert.
  - 3) Druk op  om de Timer  te verwijderen.
  - 4) Valideer door te drukken op .
  - 5) Druk 2 s op , de Timer ON1  knippert.  
Druk 1 keer op , de Timer  knippert.(\*)
  - 6) Druk op , de weergave van de uren knippert.
  - 7) Druk op  om de Timer  te verwijderen.
- (\*) Om naar de Timers 2 of  en , volgt u de stappen 1) of 4) en druk vervolgens 2 keer op . Volg de stappen hieronder.

## 4.4 Gebruiksmodus : koelen, verwarmen of auto

### In Modus "OFF" of "ON"

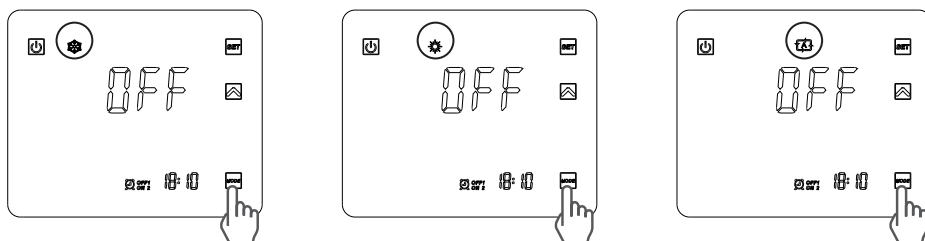

Druk op de toets  om te schakelen tussen: koelen, verwarmen of auto.



**Als de warmtepomp wordt enkel in de te verwarmen of alleen koelen modus, de modus wijzigen is niet mogelijk.**

## 4. GEBRUIKERSINTERFACE (vervolg)



### 4.5 Instelbereik en visualisatie van de gewenste waarde (Gewenste watertemperatuur)

Als de knop  niet zichtbaar is op het scherm, drukt u kort op .

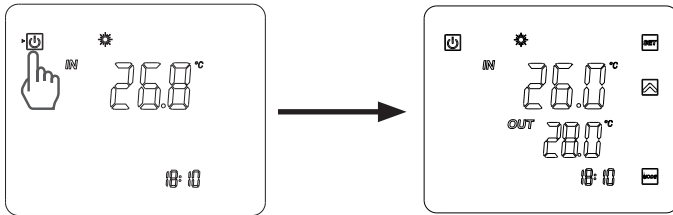
(Zowel in werking als in stilstand drukt u op de knop  om de instructies weer te geven.)



#### In Modus "OFF" en "ON"

Druk op de knop  om de instructies weer te geven, en druk vervolgens op  of  om de gewenste instructie te kiezen.

De waarde kan tot op 0.5°C nauwkeurig ingesteld worden.



**Het is aangewezen nooit de 30°C te overschrijden om te vermijden dat de liners verkleuren.**

### 4.6 Het touchscreen vergrendelen en ontgrendelen

Druk 5 sec op de Start/Stop-knop  totdat u een biep hoort en het symbool  ziet verschijnen.

Druk 5 sec op de Start/Stop-knop  totdat u een biep hoort en het symbool  ziet verdwijnen .

## 4. GEBRUIKERSINTERFACE (vervolg)

### 4.7 Instellen van de SILENCE functie (🔇)

Met deze functie kunt u de warmtepomp gebruiken met een verminderde rotatiesnelheid van de ventilatoren van 600Tr/min voor de ENP6MASC, 830Tr/min voor de ENP6TASC en 800Tr/min voor de ENP7TASC gedurende maximaal 8 uur, om geluidsoverlast 's nachts en/of overdag te beperken afhankelijk van de plaats van de pomp ten opzichte van de burens of het bassin.



Deze functie kan zowel handmatig als met behulp van een timer geactiveerd/ gedeactiveerd worden.

#### Handmatige activering

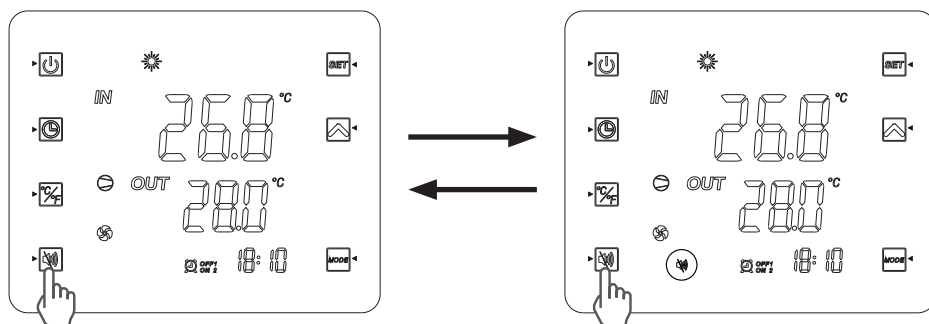
- 1) Druk op de knoppen .
- 2) De weergave hieronder verschijnt op het scherm, de stille modus is geactiveerd voor de komende 8 uur
- 3) De ventilatoren verminderen geleidelijk hun rotatiesnelheid gedurende maximaal 8 uur.
- 4) Na 8 uur wordt de functie automatisch gedeactiveerd en gaan de ventilatoren weer over op een rotatiesnelheid die afhankelijk is van de temperatuur van de buitenlucht.



#### Handmatige deactivering

- 1) Druk op de knoppen .
- 2) Het verklikkerlampje  verdwijnt van het scherm: de stille modus is gedeactiveerd.
- 3) De ventilatoren passen hun rotatiesnelheid aan op basis van de buitentemperatuur.

## 4. GEBRUIKERSINTERFACE (vervolg)



### Programmering van de STILTE modus

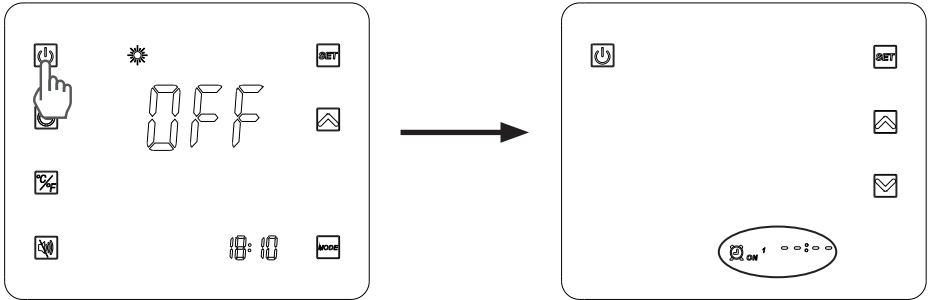

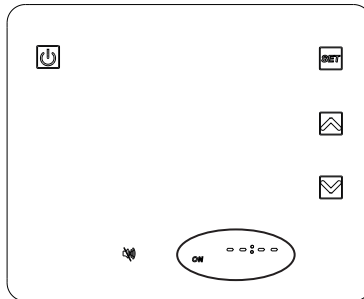

1) Druk 2 s op , de Timer ON1  ON <sup>1</sup> knippert.



2) Druk 4 keer op  tot het onderstaande scherm verschijnt.



3) Druk op , de urenweergave knippert. Gebruik de pijltjes   om de uren van de starttijd in te stellen.





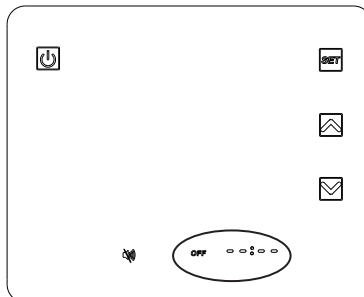



4) Druk op , de minutenweergave knippert. Gebruik de pijltjes   om de minuten van de starttijd in te stellen. Valideer door te drukken op .

5) Druk op  om de stoptijd in te stellen: de indicatie **OFF** knippert.



## 4. GEBRUIKERSINTERFACE (vervolg)

---

- 6) Druk op , de urenweergave knippert. Gebruik de pijltjes   om de uren van de stoptijd in te stellen.
- 7) Druk op , de minutenweergave knippert. Gebruik de pijltjes   om de minuten van de stoptijd in te stellen. Valideer door te drukken op .
- 8) Druk op  om terug te gaan naar het vorige scherm.  
De indicaties ON-OFF worden zoals hieronder weergegeven.

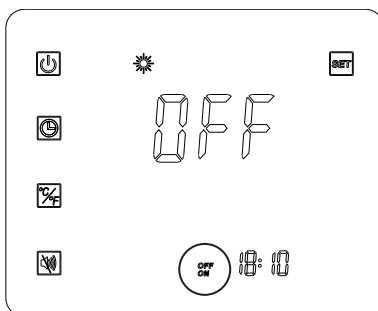

**Nota :** De minuten worden per 10 ingesteld.

Als de instelling van de SILENCE modus klaar is, wordt deze standaard 7 dagen per week geactiveerd.

## 5. ONDERHOUD EN OVERWINTERING

---

### 5.1 Onderhoud

1 keer per jaar moeten er onderhoudswerken plaatsvinden om de levensduur en een goede werking van de warmtepomp te kunnen garanderen.

- Poets de verdamper met een zachte borstel, een luchtstraal of met water **Opgelet, gebruik nooit een hogedrukreiniger**).
- Controleer of de condensaten goed afgevoerd worden.
- Controleer of de elektrische en hydraulische aansluitingen goed afsluiten.
- Controleer de hydraulische dichting van de condensor.



*Voor ieder onderhoud moet de warmtepomp ontkoppeld worden van elke elektrische bron. Onderhoud mag enkel door een gekwalificeerde en bevoegde installateur gebeuren die gewend is met koelmiddelen om te gaan.*

### 5.2 Overwintering

- Zet de warmtepomp in Modus "OFF".
- Ontkoppel de voeding van de warmtepomp.
- Maak de condensor leeg met behulp van de aflatopening om schade te vermijden. (belangrijk risico bij bevroering).
- Sluit de "by-pass"-klep af en schroef de aansluitingen op de in-/uitlaat los.
- Voer het resterende water in de condensor door middel van een luchtpistool af.
- Sluit de watertoevoer en -afvoer van de warmtepomp af om te vermijden dat vreemde voorwerpen binnendringen.
- Bedek de warmtepomp met de meegeleverde overwinteringshoes.



*Eender welke schade veroorzaakt door een slechte overwintering, zorgt ervoor dat de garantie geannuleerd wordt.*

# 6. BIJLAGEN

## 6.1 Elektrische schema's

### ENP6MASC

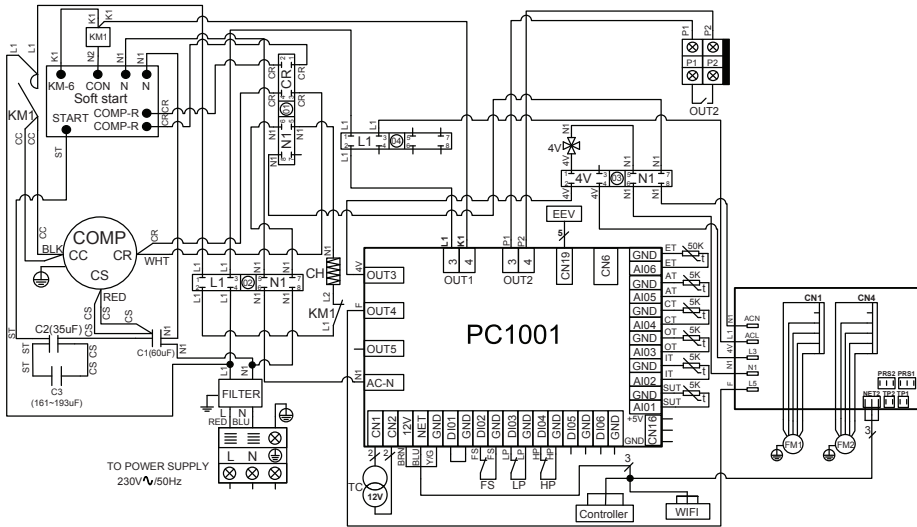

**OPMERKINGEN :**

- |   |  |
|---|--|
| <ul style="list-style-type: none"> <li>1. AT : Luchttemperatuursensor</li> <li>2. COMP : COMPRESSOR</li> <li>3. CT : CONDENSATIETEMPERatuur SENSOR</li> <li>4. EEV : ELEKTRONISCHE DRUKREGELAAR</li> <li>5. FM1-2 : VENTILATORMOTOR</li> <li>6. FS : WATERDETECTOR</li> <li>7. HP : HOGEDRUKSCHAKELAAR</li> <li>8. IT : TEMPERATUURSSENSOR VOOR BINNENKOMEND WATER</li> <li>9. LP : LAGEDRUKSCHAKELAAR</li> </ul> | <ul style="list-style-type: none"> <li>10. OT : TEMPERATUURSSENSOR VOOR BUITENGAAND WATER</li> <li>11. SUT : AANZUIGTEMPERATUURSSENSOR</li> <li>12. TC : TRANSFORMATOR 230V<math>\sim</math> / 12V<math>\sim</math></li> <li>13. 4V : 4-WEGSKRAAN</li> <li>14. KM1 : VERMAGENCONTACTOR</li> <li>15. SOFT START : ELEKTRONISCHE STARTER</li> <li>16. CH : CARTERWEERSTAND</li> <li>17. ET : TEMPERATUURSSENSOR OPSTUWING</li> <li>18. OUT2 : VOLT/VRIJ CONTACT MAX 7 A</li> </ul> |
|---|--|



# 6. BIJLAGEN (vervolg)

## ENP6TASC - ENP7TASC

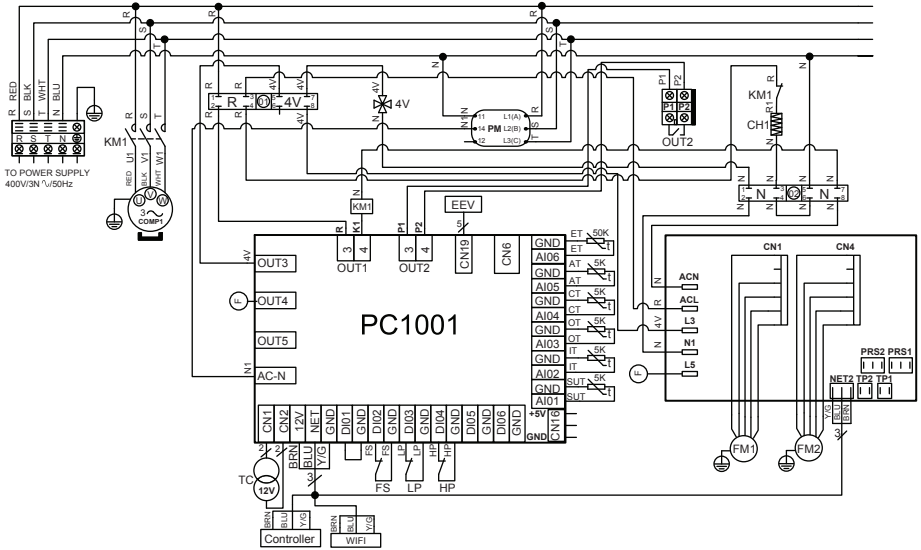

**OPMERKINGEN :**

- 1. AT : Luchttemperatuursensor
- 2. COMP : COMPRESSOR
- 3. CT : CONDENSATIETEMPERatuur SENSOR
- 4. EEV : ELEKTRONISCHE DRUKREGELAAR
- 5. FM1-2 : VENTILATORMOTOR
- 6. FS : WATERDETECTOR
- 7. HP : HOGEDRUKSCHAKELAAR
- 8. IT : TEMPERATUURSENSOR VOOR BINNENKOMEND WATER
- 9. LP : LAGEDRUKSCHAKELAAR

- 10. OT : TEMPERATUURSENSOR VOOR BUITENGAAND WATER
- 11. SUT : AANZUIGTEMPERATUURSENSOR
- 12. TC : TRANSFORMATOR 230V~/ 12V~
- 13. 4V : 4-WEGSKRAAN
- 14. KM1 : VERMAGENCONTACTOR
- 15. PM : FASEREGELAAR
- 16. CH1 : CARTERWEERSTAND
- 17. ET : TEMPERATUURSENSOR OPSTUWING
- 18. OUT2 : VOLT VRIJ CONTACT MAX 7 A

## 6. BIJLAGEN (vervolg)

### 6.2 Aansluitingen prioriteit verwarming eenfasepomp

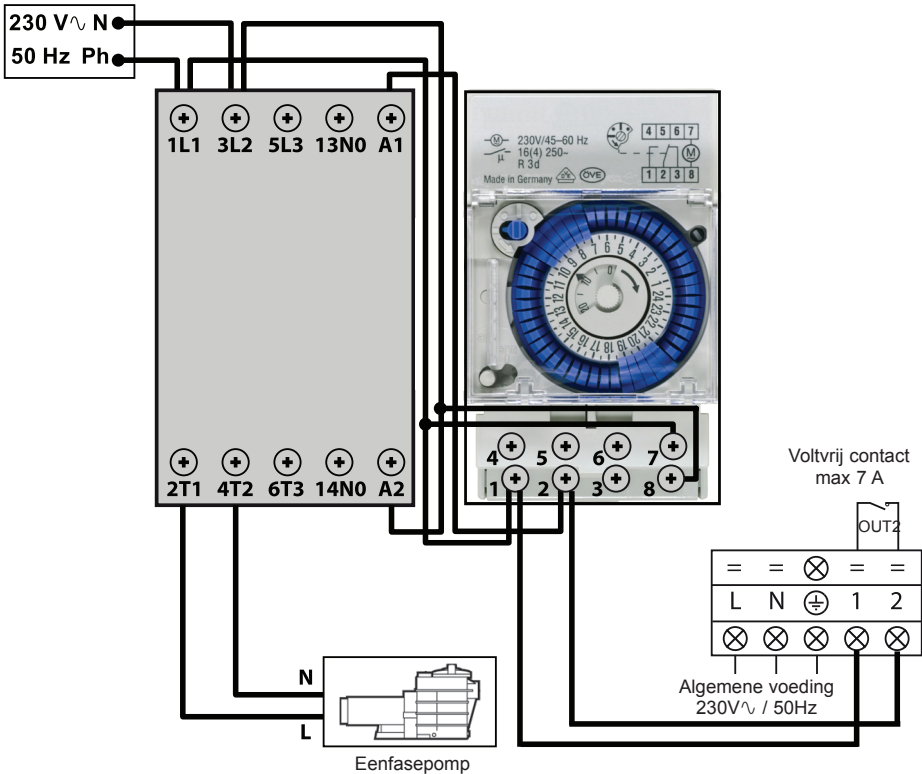

De zuilen 1-2 leveren een spanningvrij contact, zonder polariteit 230 V $\sim$  / 50 Hz.

Sluit de zuilen 1 en 2 met kabels aan zoals op het schema hierboven is aangegeven zodat de werking van de filterpomp wordt ingesteld op een cyclus van 2 minuten per uur als de temperatuur van het bassin lager is dan aanbevolen.

 De voeding van de filterpomp nooit direct aansluiten op de zuilen 1 en 2.



# 6. BIJLAGEN (vervolg)

## 6.2 Aansluitingen prioriteit verwarming driefasenpomp

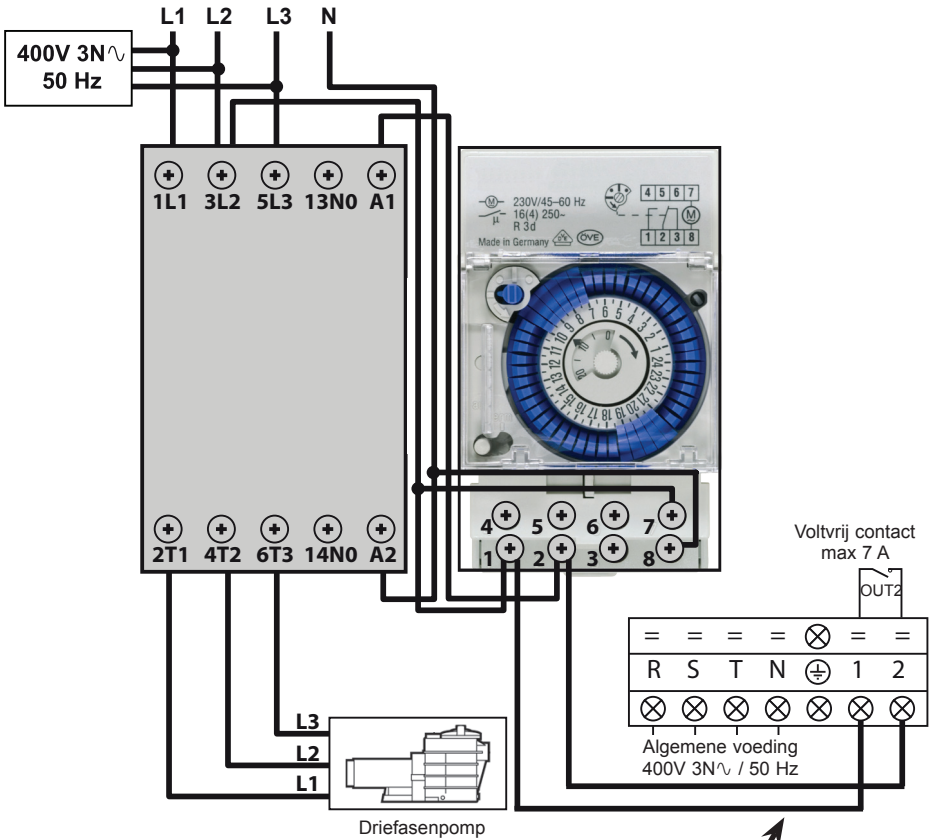

De zuilen 1-2 leveren een spanningvrij contact, zonder polariteit 230 V $\sim$  / 50 Hz.

Sluit de zuilen 1 en 2 met kabels aan zoals op het schema hierboven is aangegeven zodat de werking van de filterpomp wordt ingesteld op een cyclus van 2 minuten per uur als de temperatuur van het bassin lager is dan aanbevolen.

**!** De voeding van de filterpomp nooit direct aansluiten op de zuilen 1 en 2.



## 6. BIJLAGEN (vervolg)

### 6.3 Opengewerkte tekeningen en onderdelen

#### ENP6MASC

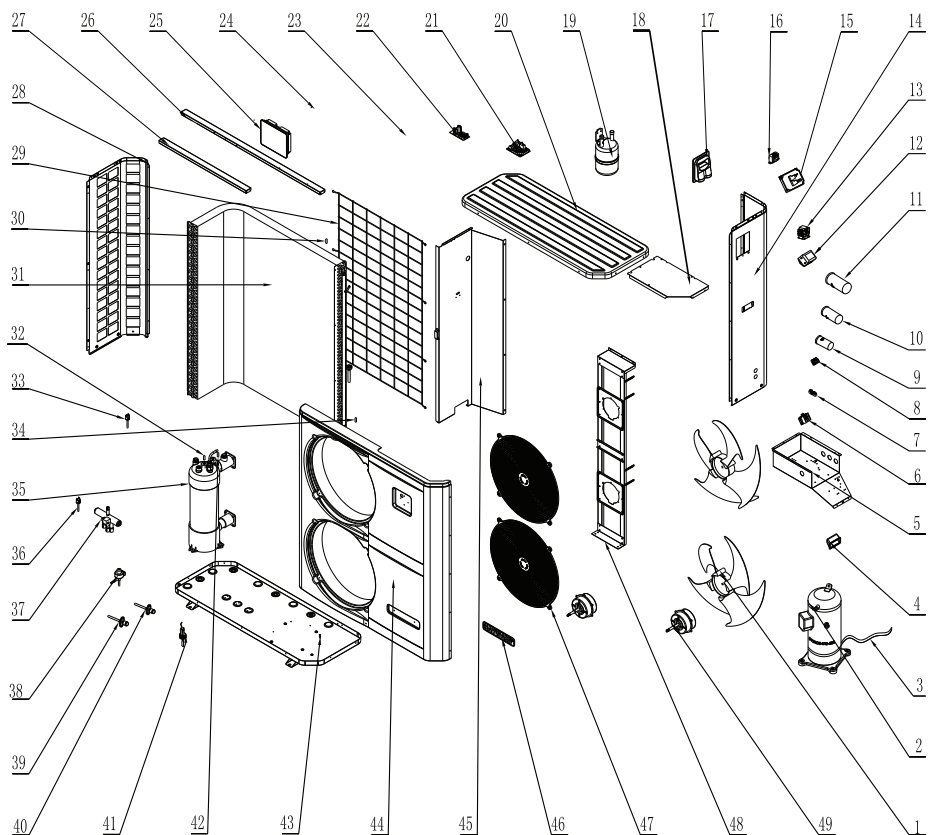

## 6. BIJLAGEN (vervolg)

### ENP6MASC

Nr.	Ref.	Omschrijving	Nr.	Ref.	Omschrijving
1	HWX20000270004	Ventilatorblad	28	HWX32019210028	Linkerpaneel
2	HWX200011112	Compressor	29	HWX32019210031	Bescherming verdamper
3	HWX20003214	Carterweerstand	30	HWX20003242	Luchttemperatuursonde
4	HWX32008220037	Handvat	31	HWX32010120008	Verdamper
5	HWX32019210040	Elektriciteitskast	32	HWX20003242	Sonde watertoevoer
6	HWX20003920	Aansluitblok 3 aansluitingen	33	HWX20013605	Hoge druk pressostaat
7	HWX20003909	Aansluitblok 2 aansluitingen	34	HWX20003242	Temperatuursonde evaporator
8	HWX20003933	Aansluitblok 3 aansluitingen	35	HWX32010120023	Titaan PVC condensor
9	HWX20003504	Condensator compressor (35µF)	36	HWX20003603	Lage druk pressostaat
10	HWX20003510	Condensator compressor (60µF)	37	HWX20011491	4-richtingsklep
11	HWX20000350011	Startcondensator (193µF)	38	HWX20000140346	Elektronisch reduceerventiel
12	HWX20003254	EMC-filter	39	HWX20000140353	Drukafpakking HD&LD
13	HWX200036007	Contactoor Compressor mono	40	HWX20000140353	Drukafpakking HD&LD
14	HWX32010210013	Rechterpaneel	41	HWX200036005	Detector waterdebiet
15	HWX20003151	Elektronische starter	42	HWX20003242	Sonde waterafvoer
16	HWX200037003	Transformator 230V <sub>~</sub> - 12V <sub>~</sub>	43	HWX32019210061	Bodem
17	HWX32009220032	Elektrische toegangsoopening	44	HWX32019210049	Voorpaneel
18	HWX32019210025	Elektrisch beschermingspaneel	45	HWX32019210026	Scheidingspaneel
19	HWX20001440	Vloeistofreservoir	46	HWX20000230596	Logo Hayward
20	HWX32019220001	Bovenpaneel	47	HWX20000220169	Beschermingsrooster ventilator
21	HWX95053114512E	Elektronische kaart	48	HWX32019210022	Motorsteun
22	HWX950531024103	Module DC Inverter	49	HWX20000330132	Motor DC
*23*	HWX20003223	Compressor-Sonde 50kΩ	*50*	HWX20002625	Silent bloc
24	/	/	*51*	HWX200026009	O-ring ID 43-Ep 3,4 mm
25	HWX95005010018	LED-regelaar	*52*	HWX200026061	O-ring ID 48-Ep 5 mm
26	HWX32019210030	Grote steun	*53*	HWX20000240112	Winterhoes
27	HWX32019210029	Kleine steun	*54*	HWX20001345	Aftapstop

NB: de punten \*XX\* zijn niet vermeld op overeenkomstige explosietekening

## 6. BIJLAGEN (vervolg)

### ENP6TASC

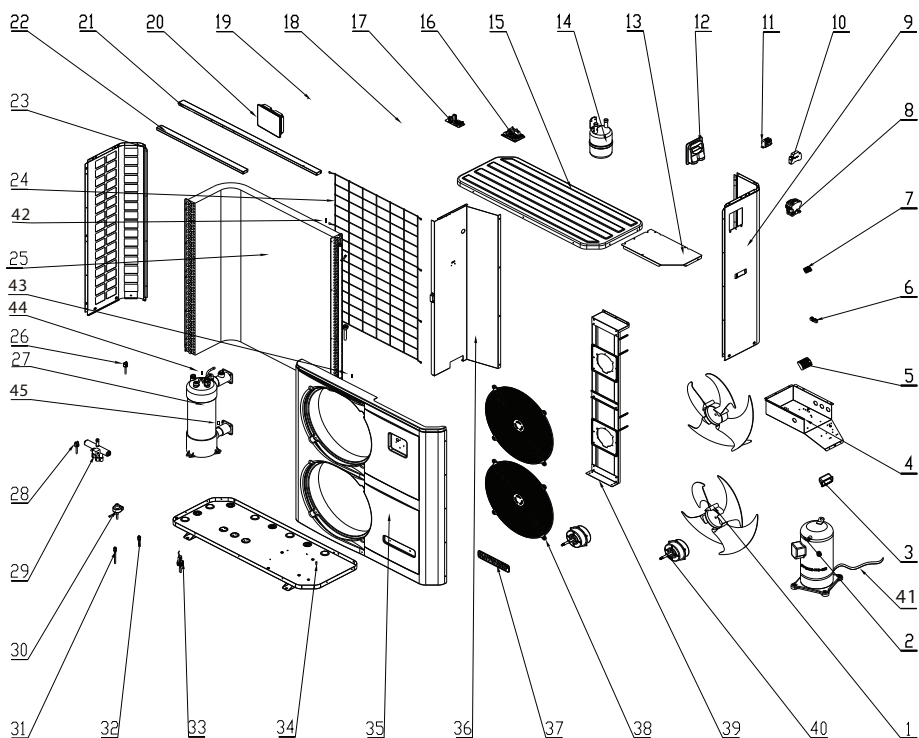

## 6. BIJLAGEN (vervolg)

### ENP6TASC

Nr.	Ref.	Omschrijving	Nr.	Ref.	Omschrijving
1	HWX20000270004	Ventilatorblad	26	HWX20013605	Hoge druk pressostaat
2	HWX20000110146	Compressor	27	HWX32019120007	Titaan PVC condensor
3	HWX32008220037	Handvat	28	HWX20003603	Lage druk pressostaat
4	HWX32019210024	Elektriciteitskast	29	HWX20011491	4-richtingsklep
5	HWX20003902	Aansluitblok 5 aansluitingen Tri	30	HWX20000140346	Elektronisch reduceerventiel
6	HWX20003909	Aansluitblok 2 aansluitingen	31		
7	HWX20003933	Aansluitblok 3 aansluitingen	32		
8	HWX20003653	Schakelaar Compressor TRI	33	HWX200036005	Waterdebiet detector
9	HWX32019210027	Rechterpaneel	34	HWX32019210061	Bodem
10	HWX200036023	Fase controller	35	HWX32019210049	Voorpaneel
11	HWX200037003	Transformator 230V <sub>~</sub> - 12V <sub>~</sub>	36	HWX32019210026	Scheidingspaneel
12	HWX32009220032	Elektrische toegangsopening	37	HWX20000230596	Logo Hayward
13	HWX32019210025	Elektrisch beschermingspaneel	38	HWX20000220169	Beschermingsrooster ventilator
14	HWX20001440	Vloeistofreservoir	39	HWX32019210022	Motorsteun
15	HWX32019220001	Bovenpaneel	40	HWX20000330132	Motor DC
16	HWX95053114510E	Elektronische kaart	41	HWX20003214	Carterweerstand
17	HWX950531024101	Module DC Inverter	42	HWX20003242	Luchttemperatuursonde
*18*	HWX20003223	Compressor-Sonde 50kΩ	43		Temperatuursonde evaporator
19	/	/	44		Sonde watertoevoer
20	HWX95005010018	LED-regelaar	45		Sonde waterafvoer
21	HWX32019210030	Grote steun	*46*	HWX20002625	Silent bloc
22	HWX32019210029	Kleine steun	*47*	HWX200026009	O-ring ID 48-Ep 5 mm
23	HWX32019210028	Linkerpaneel	*48*	HWX200026061	O-ring ID 43-Ep 3,4 mm
24	HWX32019210031	Bescherming verdamper	*49*	HWX20000240112	Winterhoes
25	HWX32010120008	Verdamper	*50*	HWX20001345	Aftapstop

NB: de punten \*XX\* zijn niet vermeld op overeenkomstige explosietekening

## 6. BIJLAGEN (vervolg)

### ENP7TASC

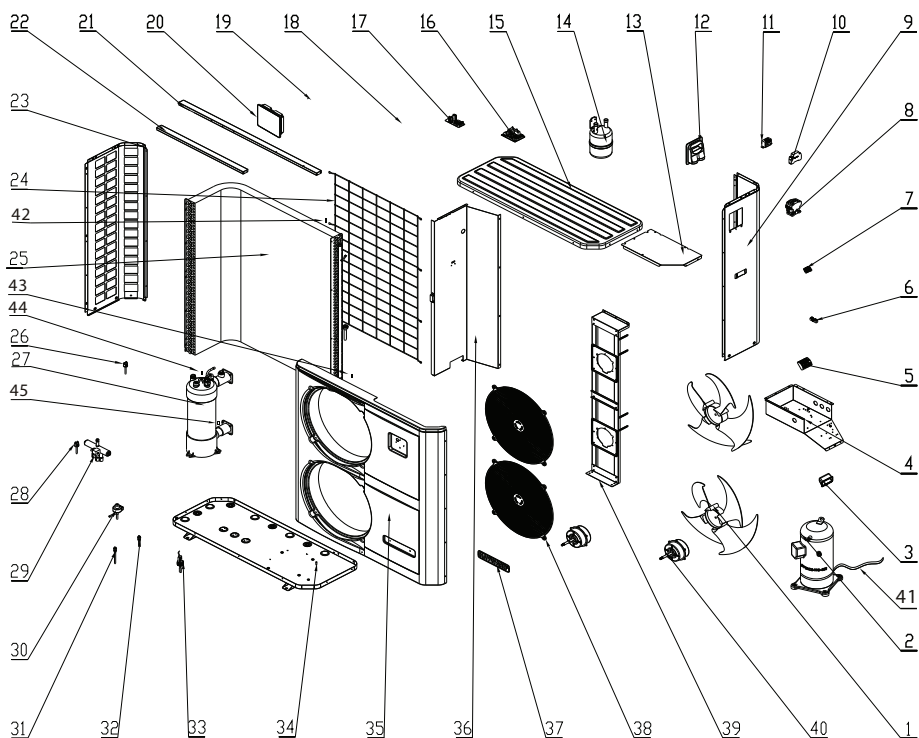



## 6. BIJLAGEN (vervolg)

### ENP7TASC

Nr.	Ref.	Omschrijving	Nr.	Ref.	Omschrijving
1	HWX20000270004	Ventilatorblad	26	HWX20013605	Hoge druk pressostaat
2	HWX20000110138	Compressor	27	HWX32019120007	Titaan PVC condensor
3	HWX32008220037	Handvat	28	HWX20003603	Lage druk pressostaat
4	HWX32019210024	Elektriciteitskast	29	HWX20011491	4-richtingsklep
5	HWX20003902	Aansluitblok 5 aansluitingen Tri	30	HWX20000140398	Elektronisch reduceerventiel
6	HWX20003909	Aansluitblok 2 aansluitingen	31		
7	HWX20003933	Aansluitblok 3 aansluitingen	32		
8	HWX20003653	Schakelaar Compressor TRI	33	HWX200036005	Detector waterdebiet
9	HWX32019210027	Rechterpaneel	34	HWX32019210061	Bodem
10	HWX200036023	Fase controller	35	HWX32019210049	Voorpaneel
11	HWX200037003	Transformator 230V <sub>~</sub> - 12V <sub>~</sub>	36	HWX32019210026	Scheidingspaneel
12	HWX32009220032	Elektrische toegangsopening	37	HWX20000230596	Logo Hayward
13	HWX32019210025	Elektrisch beschermingspaneel	38	HWX20000220169	Beschermingsrooster ventilator
14	HWX20001440	Vloeistofreservoir	39	HWX32019210022	Motorsteun
15	HWX32019220001	Bovenpaneel	40	HWX20000330132	Motor DC
16	HWX95053114511E	Elektronische kaart	41	HWX20003214	Carterweerstand
17	HWX950531024102	Module DC Inverter	42	HWX20003242	Luchttemperatuursonde
*18*	HWX20003223	Compressor-Sonde 50kΩ	43		Temperatuursonde evaporator
19	/	/	44		Sonde watertoevoer
20	HWX95005010018	LED-regelaar	45		Sonde waterafvoer
21	HWX32019210030	Grote steun	*46*	HWX20002625	Silent bloc
22	HWX32019210029	Kleine steun	*47*	HWX200026009	O-ring ID 48-Ep 5 mm
23	HWX32019210028	Linkerpaneel	*48*	HWX200026061	O-ring ID 43-Ep 3,4 mm
24	HWX32019210031	Bescherming verdamper	*49*	HWX20000240112	Winterhoes
25	HWX32019120002	Verdamper	*50*	HWX20001345	Aftapstop

NB: de punten \*XX\* zijn niet vermeld op overeenkomstige explosietekening

## 6. BIJLAGEN (vervolg)

---



### 6.4 Gids voor het probleemoplossing

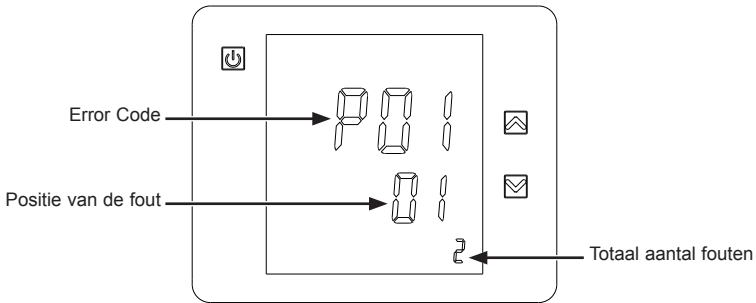

*Sommige handelingen mogen enkel door een bevoegd techniker uitgevoerd worden.*

In geval van een defect, worden de volgende indicaties op het scherm weergegeven:



In geval van meerdere fouten, drukt u op  of  om de foutcodes te bekijken. Zie het onderstaande overzicht.

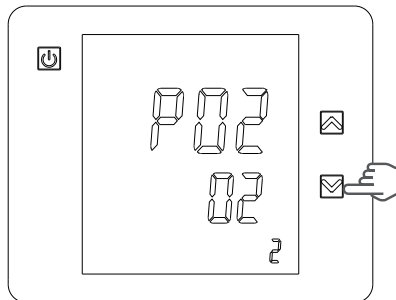

## 6. BIJLAGEN (vervolg)

Probleem	Foutcodes	Omschrijving	Oplossing
Inlaat watertemperatuur sensor fout	P01	De sensor is open of in kortsluiting	Controleer of vervang de sensor
Uitlaat watertemperatuur sensor fout	P02	De sensor is open of in kortsluiting	Controleer of vervang de sensor
Ontdooisensor fout	P05	De sensor is open of in kortsluiting	Controleer of vervang de sensor
Omgevingstemperatuursensor fout	P04	De sensor is open of in kortsluiting	Controleer of vervang de sensor
Defect aspiratiesonde compressor	P07	De sensor is open of in kortsluiting	Controleer of vervang de sensor
Temperatuurverschil tussen waterinvoer en -uitlaat is groot	E06	Volume van waterdebiet is onvoldoende, waterdrukverschil is te zwak/te hoog	Controleer het waterdebiet, of de verstopping in het systeem.
Antivriesbescherming Koude Modus	E07	Hoeveelheid uitgaand water is te zwak.	Controleer het waterdebiet of de sensor voor uitgaand water.
Antivriesbescherming van niveau 1	E19	Omgevingstemperatuur of temperatuur van het inkomend water is de laag.	
Antivriesbescherming van niveau 2	E29	Omgevingstemperatuur of temperatuur van het inkomend water is nog lager.	
Overdrukbescherming	E01	De druk van het koelcircuit is te hoog, of het waterdebiet is te zwak, of de verdamper is verstopt, of het luchtdebiet is te zwak.	Controleer de hogedrukregelaar en de druk van het koelcircuit Controleer het water- of luchtdebiet. Controleer of de debietschakelaar goed werkt. Controleer of de kranen voor binnenkomend en uitgaand water openstaan. Controleer de bypass instelling.
Onderdrukbescherming	E02	Druk van het koelcircuit is te zwak, of het luchtdebiet is te zwak, of de verdamper is verstopt.	Controleer de lagedrukregelaar en de druk van het koelcircuit om na te gaan of er een lek is. Poets de buitenkant van de verdamper. Controleer de rotatiesnelheid van de ventilator. Controleer de vrije luchtcirculatie door de verdamper.
Debietmeter fout	E03	Waterdebiet is onvoldoende of de meter is in kortsluiting of defect.	Controleer het waterdebiet, de filterpomp en de debietmeter om na te gaan of er eventuele storingen zijn.
Communicatieprobleem	E08	Probleem met de LED-controller of het PCB-connectie.	Controleer de verbinding van de kabels NET en NET1.
De compressor start niet	E08	Ontbrekende fase of onjuiste fasevolgorde	controleer de aanwezigheid van de 3 fasen wijzig de fasevolgorde op het elektrische aansluitblok van de warmtepomp

## 6. BIJLAGEN (vervolg)

---

### 6.5 Garantie

#### **GARANTIEVOORWAARDEN**

Alle HAYWARD-producten vallen onder garantie in geval van fabrieks- of materiaalfouten gedurende twee jaar vanaf de aankoopdatum. Elke garantieaanvraag moet samen met een aankoopbewijs met datum ingediend worden. Wij dringen er dus op aan dat u uw factuur bewaart. De HAYWARD-garantie is beperkt tot reparatie of vervanging, bepaald door HAYWARD, van de defecte toestellen zolang ze op een normale wijze en volgens de voorschriften die in de handleiding vermeld, gebruikt zijn, het apparaat niet aangepast is en enkel gebruikt is in met HAYWARD componenten en onderdelen. Schade veroorzaakt door vrieskou en chemische agensen vallen niet onder garantie. Alle andere kosten (transport, werkuren...) worden niet door de garantie gedekt.

HAYWARD kan niet verantwoordelijk gesteld worden voor eender welke directe of indirecte schade veroorzaakt tijdens de installatie, aansluiting of onjuist gebruik van een product.

Om een garantie aan te vragen en herstel of vervanging van een product te eisen, moet u zich tot uw verdeler wenden. Wij zullen geen enkele retour naar de fabriek aanvaarden zonder een vooraf bekomen schriftelijke goedkeuring. Slijtage valt niet onder garantie.

ISENPASC Rev C

# ***ENERGYLINE PRO***

**UNITÀ DI RISCALDAMENTO A POMPA DI CALORE PER PISCINE**



**Manuale d'Uso e di Installazione**

# INDICE

---

<b>1. Premessa</b>	<b>1</b>
<b>2. Specifiche tecniche</b>	<b>2</b>
2.1 Prestazioni dell'Unità di Riscaldamento a Pompa di Calore per Piscine	2
2.2 Soglie di funzionamento	3
2.3 Dimensioni dell'Unità di Riscaldamento a Pompa di Calore per Piscine	4
<b>3. Installazione e collegamento</b>	<b>5</b>
3.1 Schema di principio	5
3.2 Pompa di calore	6
3.3 Collegamento idraulico	6
3.4 Collegamento elettrico	7
3.5 Primo avviamento	8
3.6 Regolazione della portata d'acqua	10
<b>4. Interfaccia utente</b>	<b>11</b>
4.1 Presentazione generale	11
4.2 Configurazione dell'orologio	13
4.3 Configurazione della funzione timer	13
4.4 Selezione della modalità operativa	14
4.5 Configurazione e visualizzazione set point	15
4.6 Blocco e sblocco del touch screen	15
4.7 Regolazione modalità silenzio	16
<b>5. Manutenzione e Svernamento</b>	<b>19</b>
5.1 Manutenzione	19
5.2 Svernamento	19
<b>6. Appendici</b>	<b>20</b>
6.1 Schemi Elettrici	20
6.2 Collegamenti priorità riscaldamento	22
6.3 Esplosi e parti di ricambio	24
6.4 Guida alla Risoluzione dei Problemi	30
6.5 Garanzia	32

Leggere attentamente e riporre in luogo facilmente accessibile per la consultazione.  
La presente documentazione deve essere consegnata al proprietario della piscina, il quale dovrà conservarla in un luogo sicuro.

# 1. PREMESSA

---

Grazie per aver acquistato un'unità di riscaldamento a pompa di calore per piscine Hayward. Per garantire i livelli di qualità richiesti, questo prodotto è stato realizzato in conformità con severi standard di produzione. Il presente manuale contiene tutte le informazioni necessarie per l'installazione, la messa a punto e la manutenzione dell'unità di riscaldamento. Leggere attentamente le indicazioni qui contenute prima di aprire l'unità o eseguire su di essa operazioni di manutenzione. Il produttore di questo articolo non è responsabile in caso di incidenti alle persone o danni all'unità causati da un'installazione ed una messa a punto improprie o da una manutenzione superflua. Assicurarsi di rispettare le presenti istruzioni ad ogni utilizzo. L'unità deve essere installata da personale qualificato.

- La riparazione dell'unità deve essere effettuata da personale qualificato.
- I collegamenti elettrici devono essere effettuati esclusivamente da un professionista qualificato, nel pieno rispetto delle normative in vigore nel paese di installazione. cf. § 3.4.
- Le operazioni di manutenzione e funzionamento devono essere eseguite rispettando la frequenza e le modalità indicate nel presente manuale.
- Utilizzare esclusivamente parti di ricambio originali.
- Il mancato rispetto delle presenti indicazioni annulla la garanzia.
- L'Unità di Riscaldamento a Pompa di Calore per Piscine riscalda l'acqua della piscina e mantiene costante la temperatura. Non utilizzare per scopi diversi da quelli indicati.

Dopo aver letto il presente manuale, riporlo in luogo facilmente accessibile per la consultazione.

Avvertenze per bambini e persone con capacità fisiche ridotte.

Il presente dispositivo non è destinato a persone (in particolar modo i bambini) con capacità mentali, fisiche o sensoriali ridotte, o che non siano state edotte all'uso dello stesso, fatti salvi i casi in cui tali persone abbiano ricevuto assistenza o formazione per l'uso dell'apparecchio da una persona responsabile della loro sicurezza.

Questo prodotto contiene gas fluorurati ad effetto serra disciplinati dal Protocollo di Kyoto.

Tipo di refrigerante: R410A

Valore GWP<sup>(1)</sup>: 1975

A seconda della legislazione europea o locale in vigore, è possibile che venga richiesto di effettuare ispezioni periodiche volte ad accertare eventuali perdite di refrigerante. Per maggiori informazioni, contattare il proprio rivenditore.

---

(1) Potenziale di riscaldamento globale

## 2. SPECIFICHE TECNICHE

---

### 2.1 Prestazioni dell'Unità di Riscaldamento a Pompa di Calore per Piscine

Modelli	ENERGYLINE PRO	ENP6MASC	ENP6TASC	ENP7TASC
Potenzialità termica *	kW	17,8	18,2	23,4
Potenza elettrica assorbita*	kW	3,69	3,7	5,15
Corrente assorbita *	A	16,2	7,69 / 6,89 / 6,33	9,71 / 8,01 / 7,70
Tensione di alimentazione	V Ph/Hz	230V∨ 50Hz	400V 3N∨ 50Hz	400V 3N∨ 50Hz
Calibro fusibile tipo aM	A	20	12	16
Interruttore curva D	A	20	12	16
Numero compressori		1	1	1
Tipo di compressore		Scroll	Scroll	Scroll
Numero ventole		2	2	2
Potenza assorbita ventola	W	50 — 225	50 — 225	50 — 225
Velocità di rotazione dei ventilatori	RPM	600 — 950	830 — 960	800 — 1050
Ventilazione		Horizontal	Horizontal	Horizontal
Livello di pressione acustica (a 1 metro)	dB(A)	45	45	47
Collegamento idraulico	mm	50	50	50
Portata d'acqua nominale*	m <sup>3</sup> /h	6,6	6,6	8
Perdite di carico acqua (max.)	kPa	7	7	18
Dimensioni nette dell'unità (L/I/h)	mm	1138 / 470 / 1264	1138 / 470 / 1264	1138 / 470 / 1264
Peso netto dell'unità	kg	127	123	140

\* Valore a +/- 5% alle condizioni seguenti: Temperatura esterna = 15°C (59°F) / UR = 71% / Temperatura acqua in ingresso = 26°C (78,8°F).  
Conforme norma NF -414 (uso annuale)





## 2. SPECIFICHE TECNICHE (segue)

---

### 2.2 Soglie di funzionamento

Per assicurare un funzionamento sicuro ed efficiente, utilizzare la pompa di calore entro le seguenti soglie di temperatura e umidità.

	Modalità riscaldamento 	Modalità Raffreddamento 
Temperatura esterna	-12°C ~ +35°C	+7°C ~ +43°C
Temperatura acqua	+12°C ~ +40°C	+8°C ~ +40°C
Umidità relativa	< 80%	< 80%
Soglia di configurazione set point	+15°C ~ +32°C	+8°C ~ +32°C



***Se la temperatura o l'umidità non soddisfano le suddette condizioni, è possibile che si verifichi l'intervento di dispositivi di sicurezza che impediscano alla pompa di calore di azionarsi.***



***Per evitare eventuali rischi di deterioramento dei liner la temperatura massima di riscaldamento è limitata a 32°C. Hayward declina ogni responsabilità in caso di uso a temperature superiori a +32°C.***

## 2. SPECIFICHE TECNICHE (segue)

### 2.3 Dimensioni dell'Unità di Riscaldamento a Pompa di Calore per Piscine

Modelli: ENP6MASC / ENP6TASC / ENP7TASC

Unità di misura: mm

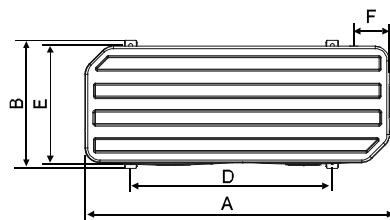
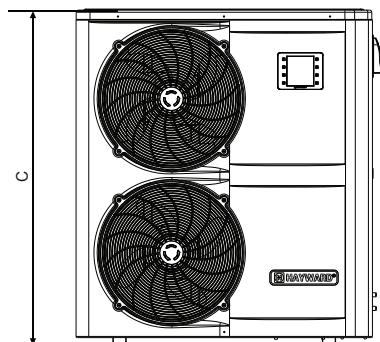
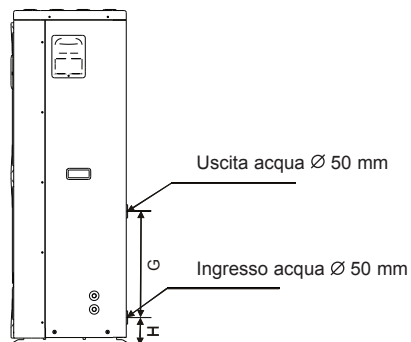

TYPE SIZE (mm)	ENP6MASC	ENP6TASC ENP7TASC
A	1138	1138
B	470	470
C	1264	1264
D	790	790
E	447	447
F	114	114
G	500	400
H	104	104

## 3. INSTALLAZIONE E COLLEGAMENTO

### 3.1 Schema di principio

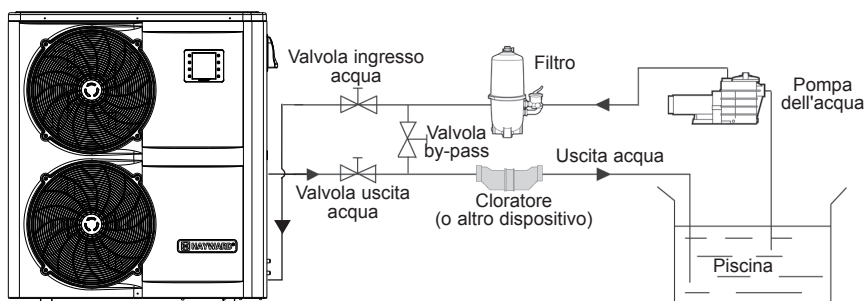

N.B.: L'unità fornita è priva di dispositivi di trattamento o di filtraggio. Gli elementi rappresentati nello schema devono essere forniti dall'installatore.

### 3.2 Pompa di calore



**Installare l'Unità di Riscaldamento a Pompa di Calore per Piscine all'esterno e al di fuori di locali tecnici chiusi.**

**Installare l'unità in luogo riparato e rispettare le distanze minime sottoindicate, al fine di evitare il rischio di ricircolo dell'aria o eventuali diminuzioni delle prestazioni complessive dell'unità stessa.**

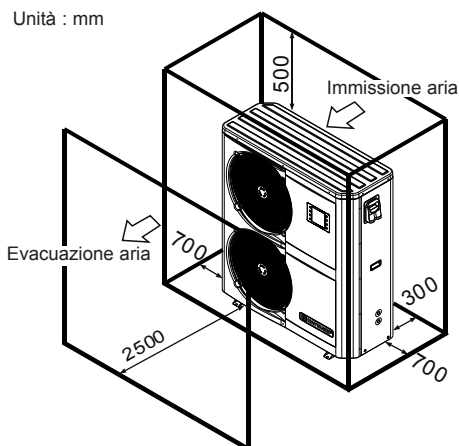

### 3. INSTALLAZIONE E COLLEGAMENTO (segue)

---



**Preferibilmente, installare l'Unità di Riscaldamento a Pompa di calore su soletta in calcestruzzo alleggerito o su apposito supporto in metallo e montare l'unità sui silentblock in dotazione (bulloneria e rondelle non fornite).**

**Distanza max. tra l'unità e la piscina: 15 metri.**

**Lunghezza totale andata/ritorno tubazioni idrauliche: 30 metri.**

**Isolare le tubazioni idrauliche sia interrate che non interrate.**

#### 3.3 Collegamento idraulico

L'unità è dotata di due raccordi di unione del diametro di 50 mm. Utilizzare tubi in PVC per tubazioni idrauliche Ø 50 mm. Collegare la tubazione per l'ingresso dell'acqua dell'unità alla conduttura proveniente dal gruppo di filtraggio, quindi collegare la tubazione per lo scarico dell'acqua alla conduttura utilizzata per immettere acqua nella piscina (cf. schema seguente).

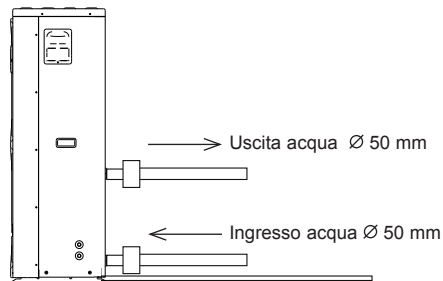

Installare una valvola by-pass tra l'ingresso e l'uscita dell'unità.



**Se si utilizza un cloratore o un cloratore automatico, installare tale dispositivo dopo l'unità, al fine di proteggere il condensatore in Titanio da una concentrazione troppo elevata di prodotto chimico.**



**Per facilitare il drenaggio dell'unità durante la preparazione all'inverno e fornire facile accesso alle operazioni di smontaggio e manutenzione, si consiglia di installare la valvola by-pass e i raccordi di unione in dotazione in corrispondenza dell'ingresso e dell'uscita dell'unità.**

### 3. INSTALLAZIONE E COLLEGAMENTO (segue)

#### 3.4 Collegamento Elettrico



**L'installazione elettrica e il cablaggio del presente dispositivo devono essere conformi alle norme d'installazione locali vigenti.**

F	NF C15-100	GB	BS7671:1992
D	DIN VDE 0100-702	EW	EVHS-HD 384-7-702
A	ÖVE 8001-4-702	H	MSZ 2364-702/1994/MSZ 10-553 1/1990
E	UNE 20460-7-702 1993, RECBT ITC-BT-31 2002	M	MSA HD 384-7-702.S2
IRL	Wiring Rules + IS HD 384-7-702	PL	PN-IEC 60364-7-702:1999
I	CEI 64-8/7	CZ	CSN 33 2000 7-702
LUX	384-7.702 S2	SK	STN 33 2000-7-702
NL	NEN 1010-7-702	SLO	SIST HD 384-7-702.S2
P	RSIUEE	TR	TS IEC 60364-7-702



**Assicurarsi che l'alimentazione elettrica disponibile e la frequenza di rete siano adeguate alla corrente operativa richiesta, tenendo in considerazione l'area di collocazione dell'unità e la corrente necessaria ad alimentare ogni altro dispositivo collegato allo stesso circuito.**

**ENP6MASC 230 V $\sim$  +/- 10 % 50 Hz 1 Phase**

**ENP6TASC 400 V $\sim$  +/- 10 % 50 Hz 3 Phases**

**ENP7TASC 400 V $\sim$  +/- 10 % 50 Hz 3 Phases**



**Accertarsi che l'equilibrio delle fasi non superi il 2%**

**Fare riferimento allo schema dell'impianto elettrico corrispondente in appendice. La scatola di collegamento è posta sul lato destro dell'unità. Tre connessioni sono destinate all'alimentazione elettrica e due al comando della pompa di filtraggio (Asservimento).**

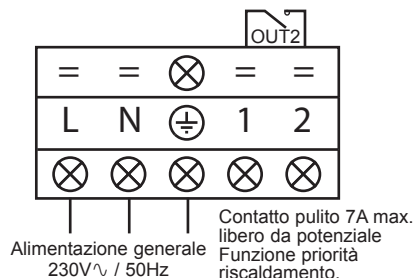
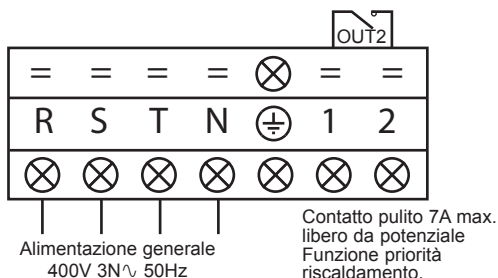

### 3. INSTALLAZIONE E COLLEGAMENTO (segue)

---



**La linea di alimentazione elettrica deve essere opportunamente provvista di salvamotore tipo alimentazione motore (aM) o di interruttore curva D e interruttore differenziale 30mA (v. tabella seguente).**

Modelli		ENP6MASC	ENP6TASC	ENP7TASC
Alimentazione elettrica	V/Ph/Hz	230V~ 50Hz	400V 3N~ 50Hz	400V 3N~ 50Hz
Calibro fusibile tipo aM	A	20 aM	12 aM	16 aM
Interruttore curva D	A	20 D	12 D	16 D
Sezione cavo	mm <sup>2</sup>	3G6 3 x 6	5G2,5 5 x 2,5	5G2,5 5 x 2,5



**Utilizzare un cavo di alimentazione tipo RO 2V / R 2V o equivalente.**



**Le sezioni del cavo sono fornite per una lunghezza massima di 25 m, ma devono comunque essere controllate e adattate a seconda delle condizioni d'installazione.**



**Staccare sempre l'alimentazione principale prima di aprire la scatola elettrica.**

#### 3.5 Primo avviamento

Procedura di avviamento - dopo aver completato l'installazione, attenersi alla seguente procedura:

- 1) Ruotare manualmente i ventilatori per verificarne la libertà di movimento e per assicurarsi che l'elica sia correttamente fissata all'albero motore.
- 2) Assicurarsi che l'unità sia correttamente collegata alla fonte di alimentazione principale (v. schema dell'impianto elettrico in appendice).
- 3) Attivare la pompa di filtraggio.
- 4) Verificare che tutte le valvole dell'acqua siano aperte e che l'acqua fluisca nell'unità prima di avviare qualsiasi processo di riscaldamento o raffreddamento.
- 5) Verificare che la manichetta per lo scarico della condensa sia correttamente collegata e che non vi sia ostacolo al suo funzionamento.
- 6) Attivare l'alimentazione elettrica destinata all'unità, quindi premere il pulsante ON/OFF  sul pannello di controllo.
- 7) Assicurarsi che non vi sia alcun codice ALLARME visualizzato sullo schermo quando l'unità è accesa (v. Guida alla Risoluzione dei Problemi).

### 3. INSTALLAZIONE E COLLEGAMENTO (segue)

- 8) Definire la portata dell'acqua agendo sulla valvola by-pass (v. § 3.6 e 2.1) secondo le indicazioni riportate sulla targhetta identificativa del modello, fino a ottenere una differenza nella temperatura dell'acqua in Ingresso/ Uscita di 2°C.
- 9) Dopo alcuni minuti di utilizzo, assicurarsi che l'aria in uscita sia più fredda (5-10°C).
- 10) Ad unità avviata, spegnere la pompa di filtraggio. L'unità si spegne automaticamente e viene visualizzato il codice errore E03.
- 11) Lasciare l'unità e la pompa piscina in funzione per 24 ore al giorno fino a quando l'acqua non raggiunge la temperatura desiderata. Quando la temperatura dell'acqua in ingresso raggiunge il valore predefinito, l'unità si spegne. L'unità si riavvia automaticamente (fino a quando la pompa della piscina rimane in funzione) quando la temperatura dell'acqua scende di 0,5°C rispetto alla temperatura impostata.

**Interruttore di portata** - L'unità è dotata di un interruttore di portata che ne regola l'accensione, quando la pompa di filtraggio della piscina è in funzione, e lo spegnimento, quando la pompa di filtraggio della piscina è fuori servizio. Se il livello dell'acqua è troppo basso, il codice d'allarme E03 viene visualizzato sul regolatore (v. § 6.4).

**Temporizzazione** - L'unità è dotata di un dispositivo di temporizzazione con ritardo di 3 minuti atto a proteggere i componenti del circuito di controllo e a prevenire avvii intempestivi e interferenze concernenti il contattore. Questa funzione riavvia automaticamente l'unità circa 3 minuti dopo ogni interruzione del circuito di controllo. Tale dispositivo si attiva anche in seguito a una breve interruzione di corrente.

**Sequenzimetro** - Le unità trifase sono dotate di un sequenzimetro che garantisce che il senso di rotazione del compressore sia corretto. Se l'unità non parte, controllare lo stato del sequenzimetro situato nella

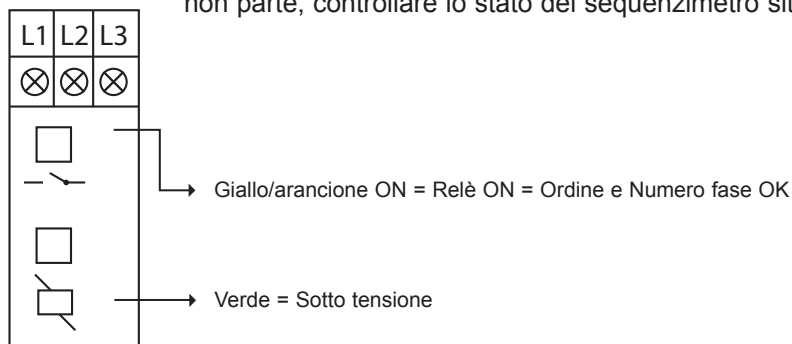

### 3. INSTALLAZIONE E COLLEGAMENTO (segue)

---

scatola di comando.

#### 3.6 Regolazione della portata d'acqua

Tenendo aperte le valvole, regolare la valvola by-pass in modo tale da ottenere una differenza di 2° C tra la temperatura dell'acqua in ingresso e la temperatura dell'acqua in uscita (v. schema di principio § 3.1). È possibile accertarsi della corretta regolazione verificando la temperatura dell'acqua in ingresso e in uscita visualizzata sul pannello di controllo.

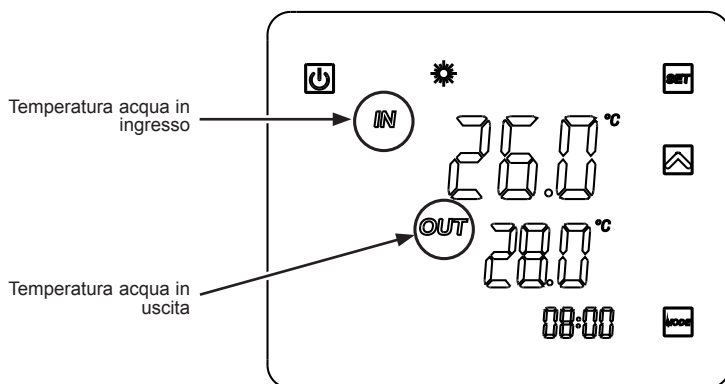

N.B.: L'apertura della valvola by-pass genera una portata minore e un conseguente aumento del  $\Delta T$ .  
La chiusura della valvola by-pass genera una portata maggiore e una conseguente diminuzione del  $\Delta T$ .



## 4. INTERFACCIA UTENTE

### 4.1 Presentazione generale

L'unità è dotata di un pannello di comando digitale touch screen collegato elettricamente e preimpostato in fabbrica in modalità riscaldamento.

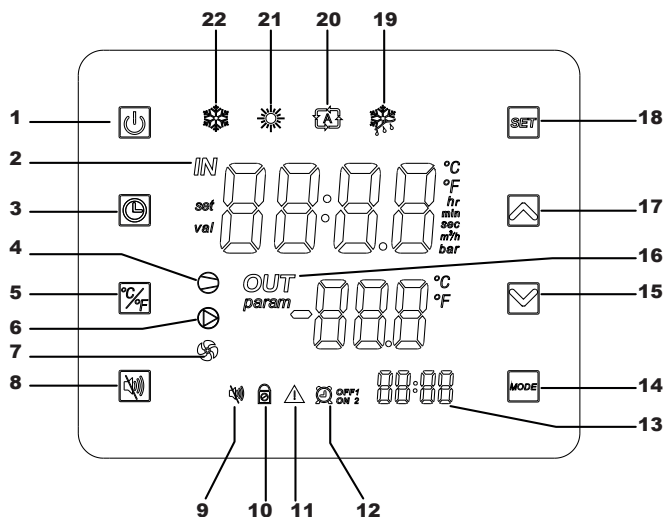

#### Legenda

1		ON/OFF	12		Timers 1 e 2
2	<i>IN</i>	Ingresso acqua	13		Ora Timers
3		Impostazione ora e Timer	14		Selezione modalità
4		Compressore ON	15		Giù / Riduci
5		Conversione °C/°F	16	<i>OUT</i>	Uscita acqua
6		Contatto a seccoOUT2	17		Su / Aumenta
7		Fan ON	18		Salva / Impostazioni
8		Modalità silenzioso	19		Modalità sbrinamento
9		Spia modalità silenzioso	20		Modalità automatica
10		Schermo bloccato	21		Modalità Riscaldamento
11		Allarme	22		Modalità Raffreddamento

## 4. INTERFACCIA UTENTE (segue)

### Modalità OFF

Quando l'unità è in stand-by (Modalità OFF), viene visualizzata sul regolatore la dicitura "OFF".

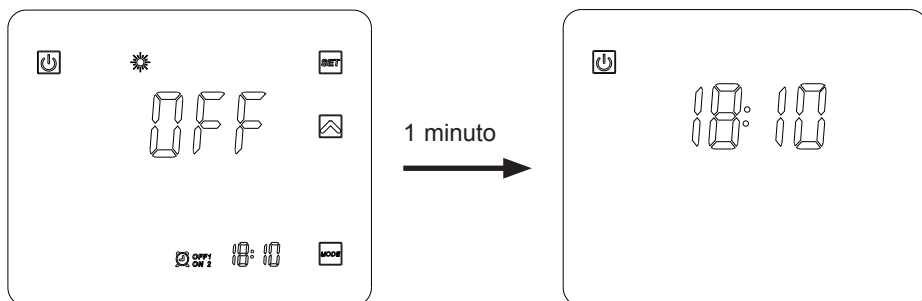

### Modalità ON

Quando l'unità è in funzione o in fase di impostazione (Modalità ON), viene visualizzata sullo schermo del regolatore la temperatura dell'acqua in ingresso e in uscita.

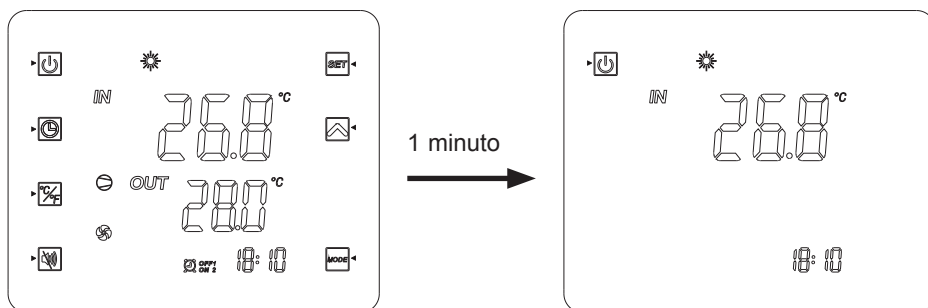









## 4. INTERFACCIA UTENTE (segue)

Al termine delle impostazioni, premere  per confermare.  
Registrazione automaticamente le impostazioni dopo 20s senza azione.

### 4.2 Configurazione dell'orologio

Se il display è stand-by premere il pulsante .









- 1) Premere  per far apparire il simbolo .
- 2) Premere , le ore lampeggiano. Impostare le ore con i pulsanti  .
- 3) Premere  e impostare i minuti usando i pulsanti  .
- 4) Confermare con .

### 4.3 Configurazione della funzione timer











La configurazione di questa funzione è necessaria se si desidera azionare l'unità per un periodo più breve rispetto a quello impostato tramite l'orologio che regola l'azionamento della pompa di filtraggio. In questo modo, è possibile ritardare l'avvio, anticipare l'arresto o impedire l'avviamento dell'unità durante una determinata fascia oraria (ad esempio di notte).



È possibile programmare fino a 2 Timer Partenza (ON1 e ON2) e 2 Timer Stop (OFF1 e OFF2).

#### Programmazione Timer 1 – Avvio

- 1) Premere  per 2s, il Timer ON1  <sup>1</sup> lampeggia (\*).
- 2) Premere  per impostare le ore usando i pulsanti  .
- 3) Premere  per impostare i minuti usando i pulsanti  .
- 4) Confermare con .

#### Programmazione Timer 1 – Fine

- 1) Premere  per 2s, il Timer ON1  <sup>1</sup> lampeggia (\*).  
Premere 1 volta , il Timer OFF1  lampeggia.
- 2) Premere  per impostare le ore usando i pulsanti  .
- 3) Premere  per impostare i minuti usando i pulsanti  .
- 4) Confermare con .

(\*) Per accedere direttamente al Timer ON2  <sup>2</sup>, premere e tenere premuto  per 2s, quindi premere 2 volte .

## 4. INTERFACCIA UTENTE (segue)



### Programmazione Timer 1

Dopo aver impostato il Timer 1 si accede direttamente all'impostazione del

Timer 2:  e .

Procedere come per il Timer 1.



**Nota:** Per accedere direttamente al Timer ON2 , premere e tenere premuto

 per 2s, quindi premere 2 volte .

### Cancellazione Timers (Avvio e Fine)

1) Premere  per 2s, il Timer ON1  lampeggia (\*).

2) Premere , le ore lampeggiano.



3) Premere  per cancellare il Timer .



4) Confermare con .

5) Premere  per 2s, il Timer ON1  lampeggia.

Premere 1 volta , il Timer  lampeggia. (\*)

6) Premere , le ore lampeggiano.

7) Premere  per cancellare il Timer .

(\*) Per accedere ai Timer 2  o , seguire le indicazioni fornite ai punti 1) o 4), quindi premere 2 volte . Procedere come indicato in precedenza.

### 4.4 Selezione della modalità operativa: raffreddamento, riscaldamento o automatico

#### In Modalità "OFF" oppure "ON"

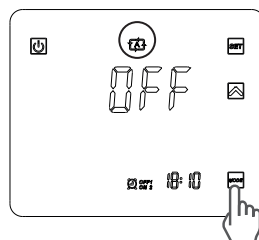
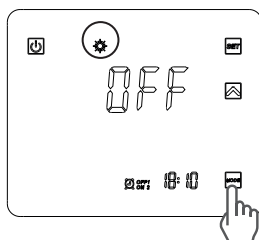
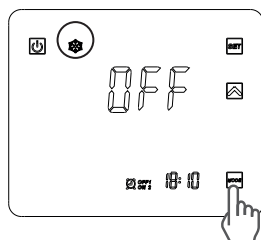

Premere il tasto  per cambiare modalità: raffreddamento, riscaldamento o automatico.



**Se la pompa di calore si trova in solo riscaldamento o solo raffreddamento modalità, il cambio di modalità non è possibile.**

## 4. INTERFACCIA UTENTE (segue)



### 4.5 Configurazione e visualizzazione set point (Temperatura dell'acqua desiderata)

Se il pulsante  non appare sullo schermo, premere .

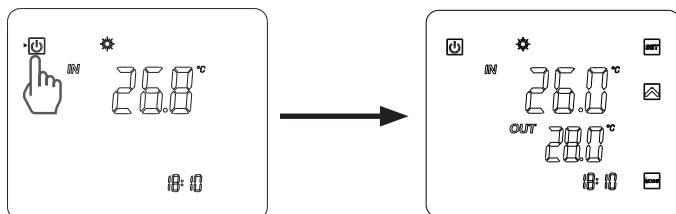
(Che il dispositivo sia in funzione o meno, per visualizzare il set point basterà premere il pulsante .)



#### In Modalità "OFF" e in Modalità "ON"

Visualizzare il set point premendo , quindi impostare il set point desiderato premendo  o .



La configurazione viene effettuata con una precisione di regolazione di 0,5 °C.



***Si raccomanda di non oltrepassare la temperatura di 30°C al fine di evitare di alterare i liner.***

### 4.6 Blocco e sblocco del touch screen

Tenere premuto il pulsante ON/OFF  per 5 sec. fino all'emissione di un segnale sonoro (bip) e alla visualizzazione del simbolo .

Per sbloccare, tenere premuto  per 5 sec. fino all'emissione di un segnale sonoro (bip) e alla visualizzazione del simbolo .

## 4. INTERFACCIA UTENTE (segue)

### 4.7 Configurazione della funzione SILENCE (🔇)



La presente funzione consente di utilizzare la pompa di calore a una velocità di rotazione dei ventilatori ridotta, pari a 600 giri/min. per ENP6MASC, 830 giri/min. per ENP6TASC e 800 giri/min. per ENP7TASC e per 8 ore max., in modo tale da limitare i rumori durante le ore notturne o diurne a seconda della collocazione della pompa rispetto alle abitazioni vicine e/o alla vasca. La funzione può essere Attivata/Disattivata manualmente o tramite un timer.

#### Attivazione Manuale

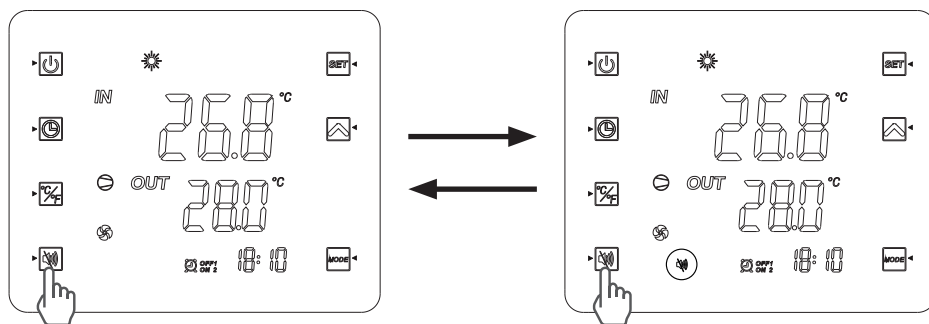
- 1) Premere il pulsante .
- 2) Sul display appare la seguente schermata, la modalità Silenzioso è attivata per 8 ore.
- 3) La velocità di rotazione dei ventilatori si riduce progressivamente tale per un totale di 8 ore max.
- 4) Dopo 8 ore di funzionamento a velocità ridotta la funzione si disattiva automaticamente e i ventilatori ricominciano a funzionare a una velocità dipendente dalla temperatura dell'aria esterna



#### Disattivazione Manuale

- 1) Premere il pulsante .
- 2) La spia  non è più visualizzata sullo schermo: la modalità Silenzioso è disattivata.
- 3) La velocità di rotazione dei ventilatori è regolata automaticamente in base alla temperatura dell'aria esterna.

## 4. INTERFACCIA UTENTE (segue)





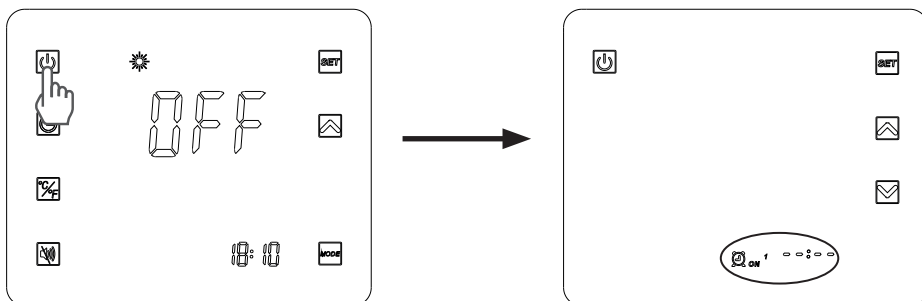

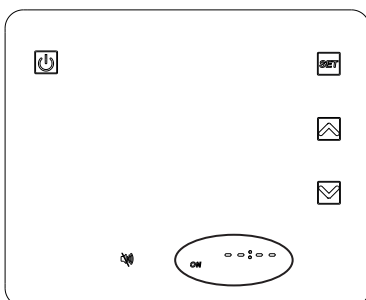

### Programmazione della modalità SILENZIO

- 1) Premere  per 2s : il Timer ON1  ON<sup>1</sup> lampeggia.



- 2) Premere 4 volte  per visualizzare la seguente schermata.





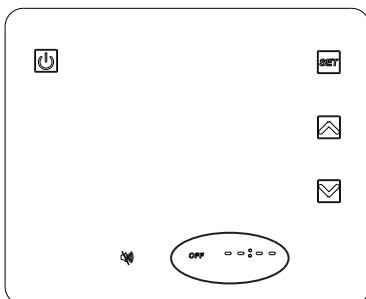





- 3) Premere , le ore lampeggiano. Impostare l'ora di inizio usando le frecce  .
- 4) Premere , i minuti lampeggiano. Impostare i minuti di inizio usando le frecce  . Confermare con .
- 5) Premere  per impostare l'ora di fine: l'indicazione OFF lampeggia.



## 4. INTERFACCIA UTENTE (segue)

---

- 6) Premere , Premere , le ore lampeggiano. Impostare l'ora di fine usando le frecce  .
- 7) Premere , i minuti lampeggiano. Impostare i minuti di fine usando le frecce  . Confermare con .
- 8) Premere  per tornare alla schermata precedente.  
Le indicazioni ON-OFF vengono visualizzate come segue.

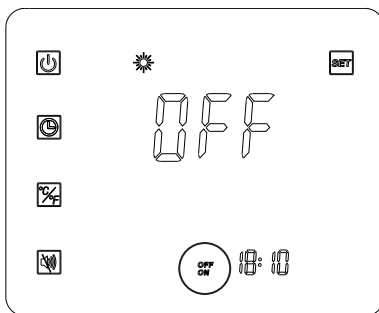

**Nota :** L'ora può essere impostata solo a intervalli di 10 minuti.

Una volta impostata, la modalità SILENCE rimane la modalità predefinita 7 giorni su 7.



## 5. MANUTENZIONE E SVERNAMENTO

---

### 5.1 Manutenzione

Per garantire la longevità e il corretto funzionamento dell'Unità di Riscaldamento a Pompa di Calore per Piscine, le presenti operazioni di manutenzione devono essere effettuate 1 volta all'anno.

- Pulire l'evaporatore con una spazzola morbida, un getto di aria compressa o con acqua (**Attenzione: non utilizzare in nessun caso idropultrici**).
- Controllare che lo scarico della condensa avvenga correttamente.
- Controllare che i collegamenti idraulici e quelli elettrici siano serrati correttamente.
- Controllare la tenuta idraulica del condensatore.



***Prima di eseguire qualsiasi operazione di manutenzione, assicurarsi che l'unità sia scollegata da ogni fonte di corrente elettrica. Le operazioni di manutenzione devono essere effettuate esclusivamente da personale qualificato e abilitato alla manipolazione di fluidi frigoriferi.***

### 5.2 Svernamento

- Mettere l'unità in Modalità "OFF".
- Interrompere l'alimentazione dell'unità.
- Svuotare il condensatore tramite l'apposito scolo per evitare eventuali rischi di degrado. (elevato rischio di congelamento).
- Chiudere la valvola by-pass e svitare i raccordi di unione ingresso/uscita.
- Eliminare dal condensatore l'acqua stagnante residua servendosi di una pistola ad aria compressa.
- Ostruire l'ingresso e l'uscita dell'acqua dell'unità, al fine di evitare l'eventuale intrusione di corpi estranei.
- Coprire l'unità con l'apposito telo per l'inverno.



***Eventuali danni causati da uno svernamento non appropriato annullano la garanzia.***

# 6. APPENDICI

## 6.1 Schemi Elettrici

### ENP6MASC

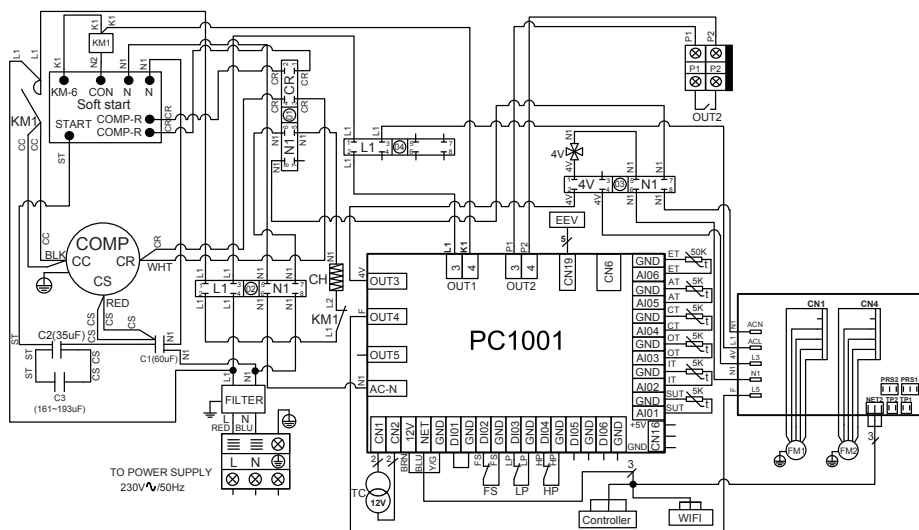

#### LEGENDA:

1. AT : SONDA TEMPERATURA ARIA
2. COMP : COMPRESSORE
3. CT : SONDA TEMPERATURA EVAPORATORE
4. EEV : REGOLATORE DI PRESSIONE ELETTRONICO
5. FM1-2 : MOTORE VENTOLA
6. FS : RILEVATORE ACQUA
7. HP : PRESSOSTATO ALTA PRESSIONE
8. IT : SONDA TEMPERATURA ACQUA IN INGRESSO
9. LP : PRESSOSTATO BASSA PRESSIONE

10. OT : SONDA TEMPERATURA ACQUA IN USCITA
11. SUT : SONDA TEMPERATURA ASPIRAZIONE
12. TC : TRASFORMATORE 230V~/ 12V~
13. 4V : VALVOLA 4 VIE
14. KM1 : CONTATTORE DI POTENZA
15. SOFT START : STARTER ELETTRONICO
16. CH : RESISTENZA CARTER
17. ET : SONDA TEMPERATURA DI MANDATA
18. OUT2 : CONTATTO PULITO LIBERO DA POTENZIALE 7A MAX.

# 6. APPENDICI (segue)

## ENP6TASC - ENP7TASC

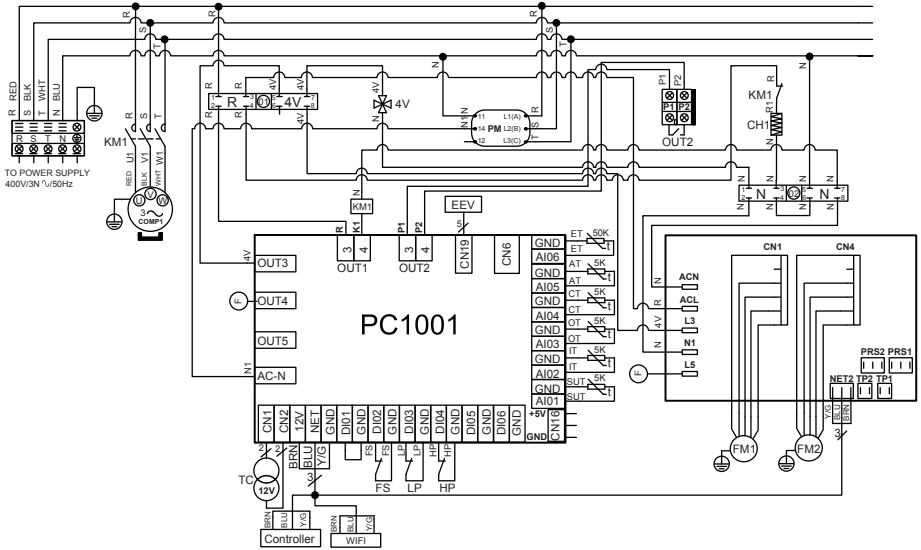

**LEGENDA:**

- 1. AT : SONDA TEMPERATURA ARIA
- 2. COMP : COMPRESSORE
- 3. CT : SONDA TEMPERATURA EVAPORATORE
- 4. EEV : REGOLATORE DI PRESSIONE ELETTRONICO
- 5. FM1-2 : MOTORE VENTOLA
- 6. FS : RILEVATORE ACQUA
- 7. HP : PRESSOSTATO ALTA PRESSIONE
- 8. IT : SONDA TEMPERATURA ACQUA IN INGRESSO
- 9. LP : PRESSOSTATO BASSA PRESSIONE

- 10. OT : SONDA TEMPERATURA ACQUA IN USCITA
- 11. SUT : SONDA TEMPERATURA ASPIRAZIONE
- 12. TC : TRASFORMATORE 230V~/ 12V~/
- 13. 4V : VALVOLA 4 VIE
- 14. KM1 : CONTATTORE DI POTENZA
- 15 : PM : SEQUENZIMETRO
- 16 : CH1 : RESISTENZA CARTER
- 17. ET : SONDA TEMPERATURA DI MANDATA
- 18. OUT2 : CONTATTO PULITO LIBERO DA POTENZIALE 7A MAX.

## 6. APPENDICI (segue)

### 6.2 Collegamenti priorità riscaldamento pompa monofase

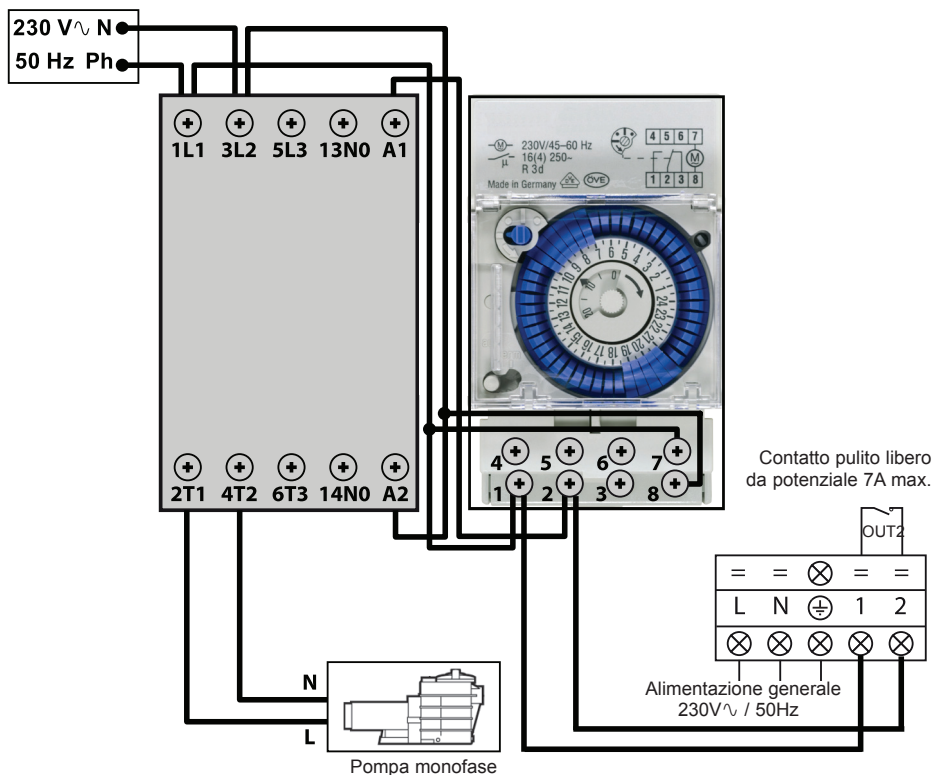

I morsetti 1 e 2 offrono un contatto pulito libero da potenziale, senza polarità 230 V $\sim$  / 50 Hz.

Collegare i morsetti 1 e 2 come indicato nello schema di cablaggio di cui sopra per garantire il funzionamento della pompa di filtraggio per un ciclo di 2 min. ogni ora qualora la temperatura all'interno della vasca fosse inferiore al set point impostato.

 Non collegare l'alimentazione della pompa di filtraggio direttamente ai morsetti 1 e 2.



## 6. APPENDICI (segue)

### 6.2 Collegamenti priorità riscaldamento pompa trifase

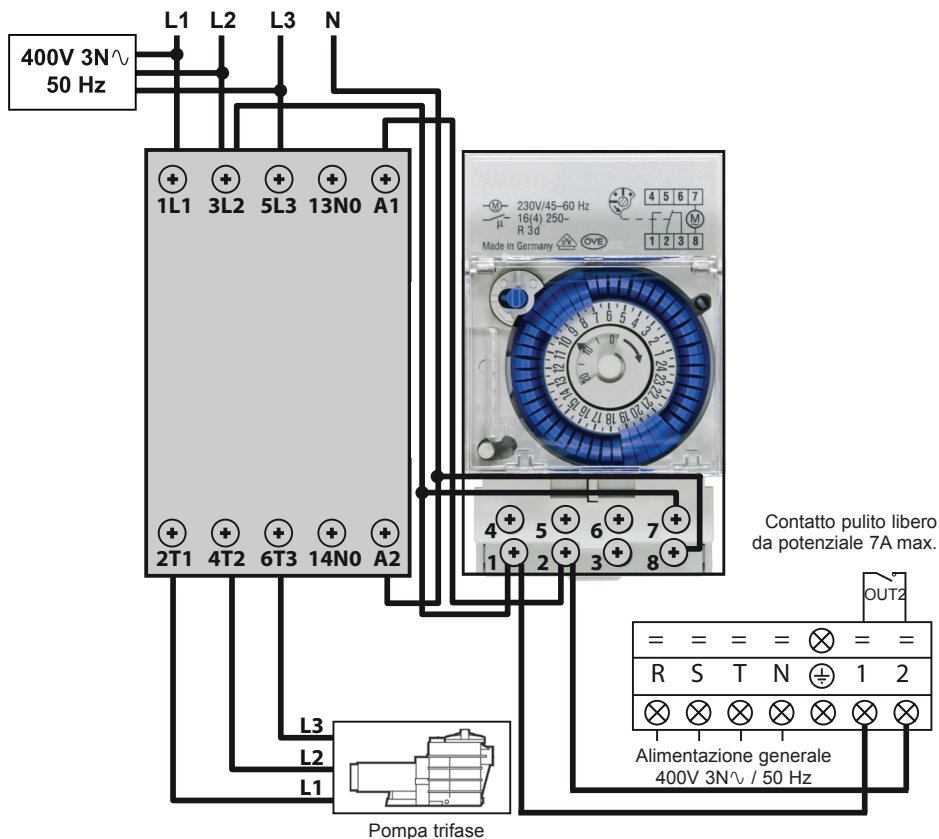

I morsetti 1 e 2 offrono un contatto pulito libero da potenziale, senza polarità 230 V $\sim$  / 50 Hz.

Collegare i morsetti 1 e 2 come indicato nello schema di cablaggio di cui sopra per garantire il funzionamento della pompa di filtraggio per un ciclo di 2 min. ogni ora qualora la temperatura all'interno della vasca fosse inferiore al set point impostato.

 Non collegare l'alimentazione della pompa di filtraggio direttamente ai morsetti 1 e 2.



## 6. APPENDICI (segue)

### 6.3 Esplosi e parti di ricambio

#### ENP6MASC

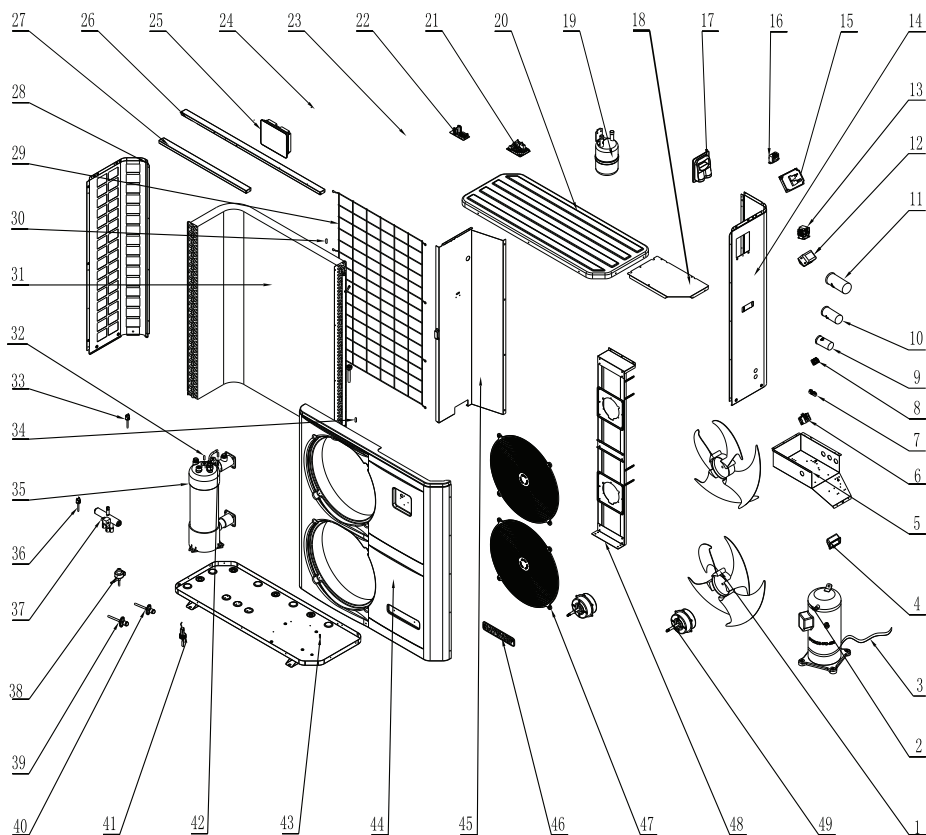

## 6. APPENDICI (segue)

### ENP6MASC

Num.	Rif.	Designazione	Num.	Rif.	Designazione
1	HWX20000270004	Elica ventilatore	28	HWX32019210028	Pannello sx
2	HWX200011112	Compressore	29	HWX32019210031	Protezione evaporatore
3	HWX20003214	Resistenza carter	30	HWX20003242	Sonda temperatura aria
4	HWX32008220037	Impugnatura	31	HWX32010120008	Evaporatore
5	HWX32019210040	Scatola di comando	32	HWX20003242	Sonda ingresso acqua
6	HWX20003920	Morsettiera 3 connessioni	33	HWX20013605	Pressostato alta pressione
7	HWX20003909	Morsettiera 2 connessioni	34	HWX20003242	Sonda temperatura evaporatore
8	HWX20003933	Morsettiera 3 connessioni	35	HWX32010120023	Condensatore Titanio PVC
9	HWX20003504	Condensatore compressore (35 $\mu$ F)	36	HWX20003603	Pressostato bassa pressione
10	HWX20003510	Condensatore compressore (60 $\mu$ F)	37	HWX20011491	Valvola 4 vie
11	HWX20000350011	Condensatore di avviamento (193 $\mu$ F)	38	HWX20000140346	Riduttore di pressione elettronico
12	HWX20003254	Filtro EMC	39	HWX20000140353	Presa della pressione AP&BP
13	HWX200036007	Contattore Compressore mono	40	HWX20000140353	Presa della pressione AP&BP
14	HWX32010210013	Pannello dx	41	HWX200036005	Rilevatore portata acqua
15	HWX20003151	Avviatore elettronico	42	HWX20003242	Sonda uscita acqua
16	HWX200037003	Transformateur 230V $\wedge$ - 12V $\wedge$	43	HWX32019210061	Fondo
17	HWX32009220032	Portello d'accesso scatola elettrica	44	HWX32019210049	Pannello anteriore
18	HWX32019210025	Pannello di protezione scatola elettrica	45	HWX32019210026	Pannello di separazione
19	HWX20001440	Serbatoio liquido	46	HWX20000230596	Logo Hayward
20	HWX32019220001	Pannello superiore	47	HWX20000220169	Griglia di protezione ventilatore
21	HWX95053114512E	Scheda elettronica	48	HWX32019210022	Supporto motore
22	HWX950531024103	Modulo DC Inverter	49	HWX20000330132	Motore DC
*23*	HWX20003223	Sonda compressore 50k $\Omega$	*50*	HWX20002625	Silent block
24	/	/	*51*	HWX200026009	O-ring ID 43 - Spess. 3.4mm
25	HWX95005010018	Regolatore LED	*52*	HWX200026061	O-ring ID 48 - Spess. 5mm
26	HWX32019210030	Tirante grande	*53*	HWX20000240112	Copertura per svernamento
27	HWX32019210029	Tirante piccolo	*54*	HWX20001345	Tappo di scarico

N.B.: I riferimenti \*xx\* non sono indicati nell'esploso corrispondente.

## 6. APPENDICI (segue)

### ENP6TASC

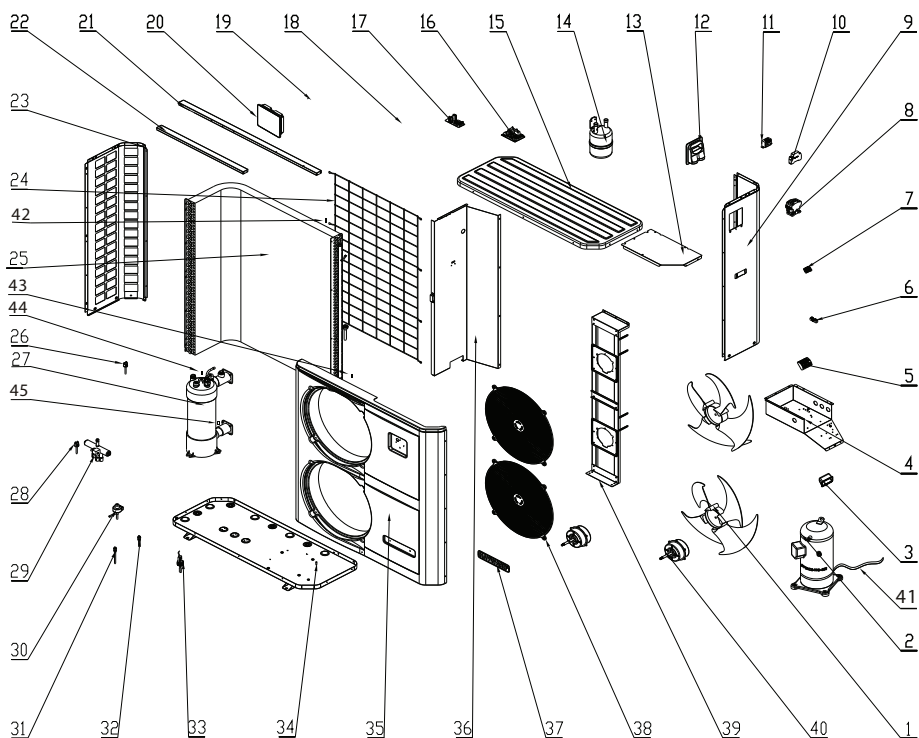



## 6. APPENDICI (segue)

### ENP6TASC

Num.	Rif.	Designazione	Num.	Rif.	Designazione
1	HWX20000270004	Elica ventilatore	26	HWX20013605	Pressostato alta pressione
2	HWX20000110146	Compressore	27	HWX32019120007	Condensatore Titanio PVC
3	HWX32008220037	Impugnatura	28	HWX20003603	Pressostato bassa pressione
4	HWX32019210024	Scatola di comando	29	HWX20011491	Valvola 4 vie
5	HWX20003902	Morsettiera 5 connessioni Tri	30	HWX20000140346	Riduttore di pressione elettronico
6	HWX20003909	Morsettiera 2 connessioni	31		
7	HWX20003933	Morsettiera 3 connessioni	32		
8	HWX20003653	Contattore Compressore TRI	33	HWX200036005	Sensore portata acqua
9	HWX32019210027	Pannello dx	34	HWX32019210061	Fondo
10	HWX200036023	Sequenzimetro	35	HWX32019210049	Pannello anteriore
11	HWX200037003	Transformateur 230V $\surd$ - 12V $\surd$	36	HWX32019210026	Pannello di separazione
12	HWX32009220032	Portello d'accesso scatola elettrica	37	HWX20000230596	Logo Hayward
13	HWX32019210025	Pannello di protezione scatola elettrica	38	HWX20000220169	Griglia di protezione ventilatore
14	HWX20001440	Serbatoio liquido	39	HWX32019210022	Supporto motore
15	HWX32019220001	Pannello superiore	40	HWX20000330132	Motore DC
16	HWX95053114510E	Scheda elettronica	41	HWX20003214	Resistenza carter
17	HWX950531024101	Modulo DC Inverter	42	HWX20003242	Sonda temperatura aria
*18*	HWX20003223	Sonda compressore 50k $\Omega$	43		Sonda temperatura evaporatore
19	/	/	44		Sonda ingresso acqua
20	HWX95005010018	Regolatore LED	45		Sonda uscita acqua
21	HWX32019210030	Tirante grande	*46*	HWX20002625	Silent block
22	HWX32019210029	Tirante piccolo	*47*	HWX200026009	O-ring ID 48 - Spess. 5mm
23	HWX32019210028	Pannello sx	*48*	HWX200026061	O-ring ID 43 - Spess. 3.4mm
24	HWX32019210031	Protezione evaporatore	*49*	HWX20000240112	Copertura per svernamento
25	HWX32010120008	Evaporatore	*50*	HWX20001345	Tappo di scarico

N.B.: I riferimenti \*xx\* non sono indicati nell'esploso corrispondente.

## 6. APPENDICI (segue)

---

### ENP7TASC

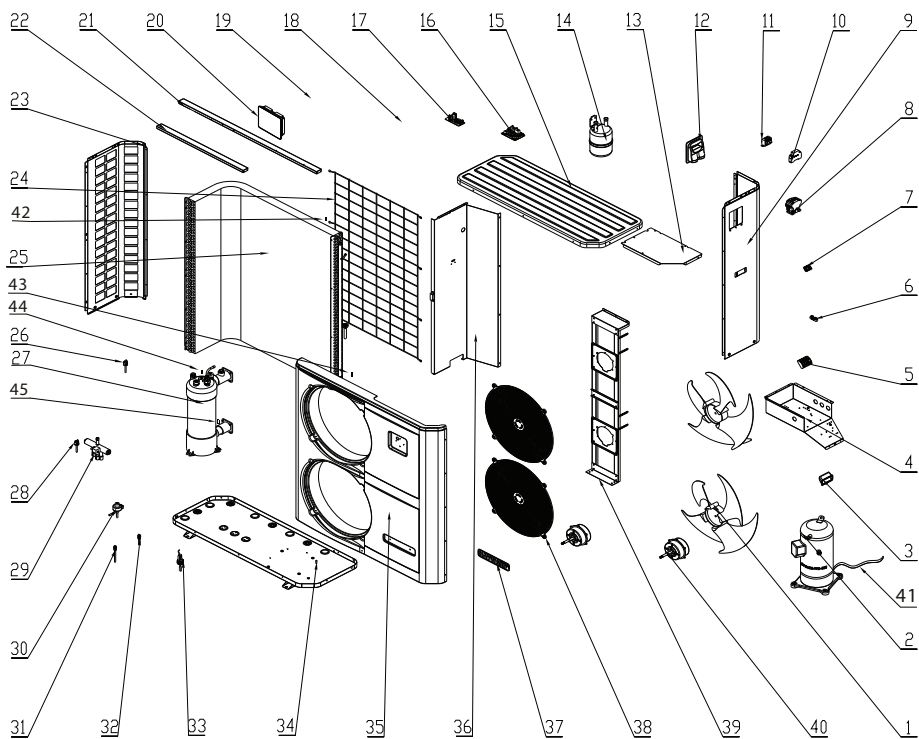

## 6. APPENDICI (segue)

### ENP7TASC

Num.	Rif.	Designazione	Num.	Rif.	Designazione
1	HWX20000270004	Elica ventilatore	26	HWX20013605	Pressostato alta pressione
2	HWX20000110138	Compressore	27	HWX32019120007	Condensatore Titanio PVC
3	HWX32008220037	Impugnatura	28	HWX20003603	Pressostato bassa pressione
4	HWX32019210024	Scatola di comando	29	HWX20011491	Valvola 4 vie
5	HWX20003902	Morsettiera 5 connessioni Tri	30	HWX20000140398	Riduttore di pressione elettronico
6	HWX20003909	Morsettiera 2 connessioni	31		
7	HWX20003933	Morsettiera 3 connessioni	32		
8	HWX20003653	Contattore Compressore TRI	33	HWX200036005	Rilevatore portata acqua
9	HWX32019210027	Pannello dx	34	HWX32019210061	Fondo
10	HWX200036023	Sequenzimetro	35	HWX32019210049	Pannello anteriore
11	HWX200037003	Transformateur 230V $\sqrt{v}$ -12V $\sqrt{v}$	36	HWX32019210026	Pannello di separazione
12	HWX32009220032	Portello d'accesso scatola elettrica	37	HWX20000230596	Logo Hayward
13	HWX32019210025	Pannello di protezione scatola elettrica	38	HWX20000220169	Griglia di protezione ventilatore
14	HWX20001440	Serbatoio liquido	39	HWX32019210022	Supporto motore
15	HWX32019220001	Pannello superiore	40	HWX20000330132	Motore DC
16	HWX95053114511E	Scheda elettronica	41	HWX20003214	Resistenza carter
17	HWX950531024102	Modulo DC Inverter	42	HWX20003242	Sonda temperatura aria
*18*	HWX20003223	Sonda compressore 50k $\Omega$	43		Sonda temperatura evaporatore
19	/	/	44		Sonda ingresso acqua
20	HWX95005010018	Regolatore LED	45		Sonda uscita acqua
21	HWX32019210030	Tirante grande	*46*	HWX20002625	Silent block
22	HWX32019210029	Tirante piccolo	*47*	HWX200026009	-O-ring ID 48 - Spess. 5mm
23	HWX32019210028	Pannello sx	*48*	HWX200026061	O-ring ID 43 - Spess. 3.4mm
24	HWX32019210031	Protezione evaporatore	*49*	HWX20000240112	Copertura per svernamento
25	HWX32019120002	Evaporatore	*50*	HWX20001345	Tappo di scarico

N.B.: I riferimenti \*xx\* non sono indicati nell'esploso corrispondente.

## 6. APPENDICI (segue)

---



### 6.4 Guida alla Risoluzione dei Problemi

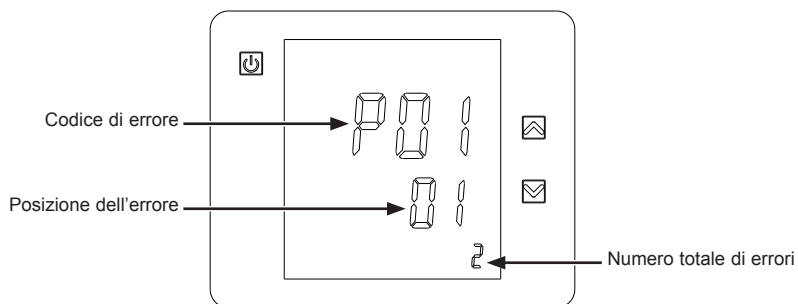

**Alcune delle presenti operazioni devono essere effettuate da un tecnico autorizzato.**

In caso di problemi sullo schermo compaiono le seguenti indicazioni:



Nel caso in cui vengano rilevati più errori, per passare da un codice errore all'altro premere  o . Fare riferimento alla tabella seguente.

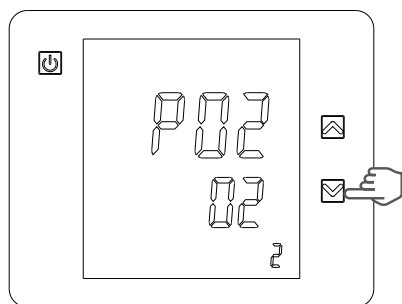

## 6. APPENDICI (segue)

Malfunzionamento	Codice errore	Descrizione	Soluzione
Guasto sonda temperatura acqua in ingresso	P01	Il sensore è aperto o si è verificato un corto circuito.	Controllare o sostituire il sensore.
Guasto sonda acqua in uscita	P02	Il sensore è aperto o si è verificato un corto circuito.	Controllare o sostituire il sensore.
Guasto sonda antigelo	P05	Il sensore è aperto o si è verificato un corto circuito.	Controllare o sostituire il sensore.
Guasto sonda temperatura esterna	P04	Il sensore è aperto o si è verificato un corto circuito.	Controllare o sostituire il sensore.
Guasto sonda di aspirazione compressore	P07	Il sensore è aperto o si è verificato un corto circuito.	Controllare o sostituire il sensore.
Differenza di temperatura tra acqua in ingresso e acqua in uscita troppo ampia	E06	Volume portata d'acqua insufficiente, differenza pressione acqua troppo bassa/troppo elevata	Controllare il volume della portata d'acqua o se il sistema è ostruito da corpi estranei.
Protezione antigelo Modalità raffreddamento	E07	Portata acqua in uscita troppo bassa.	Controllare il volume della portata d'acqua o il sensore della temperatura dell'acqua in uscita.
Protezione antigelo livello 1	E19	Temperatura ambiente o temperatura dell'acqua in ingresso troppo bassa.	
Protezione antigelo livello 2	E29	Temperatura ambiente o temperatura dell'acqua in ingresso ancora più bassa.	
Protezione alta pressione	E01	Pressione del circuito frigorifero troppo alta, portata dell'acqua troppo bassa, evaporatore ostruito o flusso d'aria insufficiente.	Controllare il pressostato alta pressione e la pressione del circuito frigorifero. Controllare il volume della portata d'acqua o il flusso d'aria. Controllare il corretto funzionamento dell'interruttore di portata. Controllare l'apertura delle valvole di ingresso/uscita acqua. Controllare la regolazione del by-pass.
Protezione bassa pressione	E02	Pressione del circuito frigorifero troppo bassa, flusso d'aria insufficiente o evaporatore ostruito.	Controllare il pressostato bassa pressione e la pressione del circuito frigorifero per individuare eventuali perdite. Pulire la superficie dell'evaporatore. Controllare la velocità di rotazione della ventola. Controllare che l'aria circoli liberamente attraverso l'evaporatore.
Guasto sensore di portata	E03	Portata d'acqua insufficiente o sensore in cortocircuito o difettoso	Controllare la portata d'acqua e accertarsi che la pompa e il sensore di portata non abbiano subito danni.
Guasto nel circuito di comunicazione	E08	Guasto del dispositivo di controllo a LED o del collegamento dei circuiti stampati.	Controllare il collegamento dei cavi NET e NET 1.
Il compressore non parte	E08	Fase mancante o ordine fasi non corretto	accertarsi della presenza delle 3 fasi modificare l'ordine delle fasi sulla morsettiera di collegamento elettrico della pompa di calore

## 6. APPENDICI (segue)

---

### 6.5 Garanzia

#### CONDIZIONI DI GARANZIA

Tutti i prodotti Hayward sono garantiti contro tutti vizi de fabbricazione o di materiale per il periodo di due anni a partira dalla data di acquisto. Tutte le richieste di applicazione della garanzia dovranno essere accompagnate da un documento che ne provi la data di acquisto (conservate copia della fattura).

Hayward potra' riparare o sostituire, a suo insindacabile guidizio. I materiali o i componenti riconosciuti diffetosi a condizione che siano stati correttamente installati ed utilizzati, secondo le istruzioni fornite, che non abbiano subito modifiche di alcun genere e siano equipaggiati esclusivamente di ricambi e compomenti originali Hayward. I danni provocati dal gelo o da prodotti chimici non sono coperti dalla garanzia.

Hayward non sara'responsabile in alcun modo di danni diretti o indiretti derivati dal non corretto funzionamento di un suo prodotto.

Per attivare la garanzia e richiedere la riparazione o sostituzione di un articolo, consultate il rivenditore di zona. Nessun reso di materiale sara'accettato senza il nostro preventivo accordo scritto.

Le parti di usura non sono coperte della garanzia.

ISENPASC Rev C

# ***ENERGYLINE PRO***

**VARMEPUMPE TIL SVØMMEBASSENG**



**Installerings- og brukerveiledning**

# INNHold

---

<b>1. Innledning</b>	<b>1</b>
<hr/>	
<b>2. Spesifikasjoner</b>	<b>2</b>
2.1 Varmepumpens ytelse	2
2.2 Driftsområde	3
2.3 Varmepumpens dimensjoner	4
<hr/>	
<b>3. Installering og tilkobling</b>	<b>5</b>
3.1 Skjematisk diagram	5
3.2 Varmepumpe	6
3.3 Vanntilkobling	6
3.4 Elektrisk tilkobling	7
3.5 Førstegangs oppstart	8
3.6 Innstilling av vannstrømmen	10
<hr/>	
<b>4. Brukergrensesnitt</b>	<b>11</b>
4.1 Oversikt	11
4.2 Innstilling av tid	13
4.3 Innstilling av Timer	13
4.4 Valg av driftsmodus	14
4.5 Innstilling og visning av settpunkt	15
4.6 Låse og låse opp berøringsskjermen	15
4.7 Stillemodusinnstilling	16
<hr/>	
<b>5. Vedlikehold og Vinterklargjøring</b>	<b>19</b>
5.1 Vedlikehold	19
5.2 Vinterklargjøring	19
<hr/>	
<b>6. Vedlegg</b>	<b>20</b>
6.1 Elektriske diagrammer	20
6.2 Tilkoblinger oppvarmingsprioritet	22
6.3 Sprengskisse og reservedeler	24
6.4 Veiledning for feilsøking	30
6.5 Garanti	32

Vennligst les nøye og ta vare på for fremtidig referanse.

Dette dokumentet må være levert til svømmebassengets eier, og må oppbevares på et trygt sted.



# 1. INNLEDNING

---

Takk for at du kjøpte denne Hayward varmepumpen til svømmebasseng. Dette produktet har blitt utformet i henhold til strenge produksjonsstandarder for å oppfylle det nødvendige kvalitetsnivået. Denne brukerveiledningen inkluderer all nødvendig informasjon vedrørende installering, feilretting, og vedlikehold. Les denne brukerveiledningen nøye før du åpner eller foretar vedlikeholdsoperasjoner. Produsenten av dette produktet holdes ikke ansvarlig om noen skulle bli skadet, eller om enheten blir skadet under ukorrekt installering, feilretting, eller unødvendig vedlikehold. Det er svært viktig at instruksjonene i brukerveiledningen følges nøye. Enheten må installeres av kvalifisert personell.

- Reparasjoner må kun utføres av kvalifisert personell.
- Alle strømtilkoblinger skal utføres av en godkjent elektriker og ifølge gjeldende standarder i installasjonslandet jf kapittel 3.4.
- Vedlikehold og drift må utføres til anbefalte tidspunkt, som oppgitt i denne brukerveiledningen.
- Bruk kun originale reservedeler.
- Om disse anbefalingene ikke følges blir garantien ugyldig.
- Denne varmepumpen varmer opp bassengvannet og holder temperaturen jevn. Ikke bruk til andre formål.

Etter å ha lest denne brukerveiledningen, ta vare på den for senere referanse. Advarsler vedrørende barn / funksjonshemmede personer:

Dette apparatet er ikke beregnet til bruk av funksjonshemmede personer (medregnet barn), eller personer uten erfaring eller kunnskaper, unntatt hvis en person ansvarlig for deres sikkerhet fører tilsyn med dem eller har gitt dem opplæring om apparatets anvendelse.

Dette produktet inneholder fluorholdige klimagasser som er gjeldende under Kyoto-protokollen.

Type kuldemedium: R410A

GWP-verdi<sup>(1)</sup>: 1975

Periodiske inspeksjoner av lekkasje av kuldemedium kan være nødvendig avhengig av europeisk eller lokalt regelverk. Vennligst kontakt din lokale forhandler for mer informasjon.

---

(1) Global Warming Potential

## 2. SPESIFIKASJONER

---

### 2.1 Varmepumpens ytelse

Modell	ENERGYLINE PRO	ENP6MASC	ENP6TASC	ENP7TASC
Varmekapasitet*	kW	17,8	18,2	23,4
Strømforbruk *	kW	3,69	3,7	5,15
Strøm*	A	16,2	7,69 / 6,89 / 6,33	9,71 / 8,01 / 7,70
Strømforsyning	V Ph/Hz	230V~ 50Hz	400V 3N~ 50Hz	400V 3N~ 50Hz
Sikringsstørrelse av typen aM	A	20	12	16
Effektbryter Kurve D	A	20	12	16
Antall kompressorer		1	1	1
Kompressortype		Scroll	Scroll	Scroll
Antall viffter		2	2	2
Vifte	W	50 — 225	50 — 225	50 — 225
Viftens rotasjonshastighet	RPM	600 — 950	830 — 960	800 — 1050
Vifteretning		Horizontal	Horizontal	Horizontal
Lydtrykknivå (ved 1 meter)	dB(A)	45	45	47
Vanntilkobling	mm	50	50	50
Nominell sirkulasjonsmengde*	m <sup>3</sup> /h	6,6	6,6	8
Fall i vanntrykk (maks.)	kPa	7	7	18
Dimensjoner, netto (L/V/H)	mm	1138 / 470 / 1264	1138 / 470 / 1264	1138 / 470 / 1264
Enhetens nettovekt	kg	127	123	140

\* Verdi på +/- 5 % ved følgende betingelser: Utetemperatur = 15 °C (59 °F) / Relativ fuktighet = 71 % / Temperatur til vanninnløp = 26 °C (78,8 °F).



Samsvarer med NF-standard -414 (årlig bruk)

## 2. SPESIFIKASJONER (fortsetter)

---

### 2.2 Driftsområde

Bruk varmepumpen i de følgende temperatur- og fuktighetsområder for å sikre en trygg og effektiv drift.

	Oppvarmingsmodus 	Kjølemodus 
Utetemperatur	-12°C ~ +35°C	+7°C ~ +43°C
Vanntemperatur	+12°C ~ +40°C	+8°C ~ +40°C
Relativ luftfuktighet	< 80%	< 80%
Innstillingsområde for settpunkt	+15°C ~ +32°C	+8°C ~ +32°C



**Hvis temperatur eller luftfuktighet ikke samsvarer med disse betingelsene, kan sikkerhetsanordninger aktiveres og varmepumpen slutte å fungere.**



**Maksimumstemperaturen for oppvarming er begrenset til 32°C for å unngå forringelse av foringene. Hayward fraskriver seg alt ansvar i tilfelle av en bruk utover 32°C.**

## 2. SPESIFIKASJONER (fortsetter)

### 2.3 Dimensjoner

Modeller: ENP6MASC / ENP6TASC / ENP7TASC

Enhet: mm

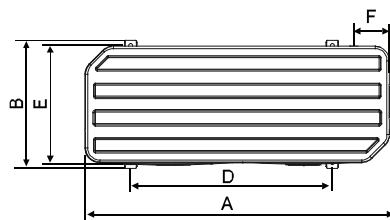
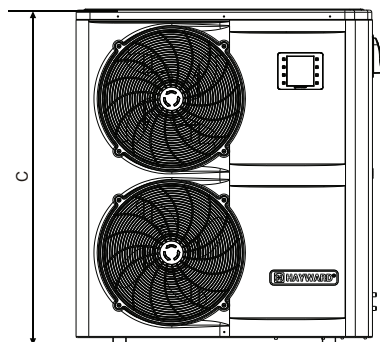
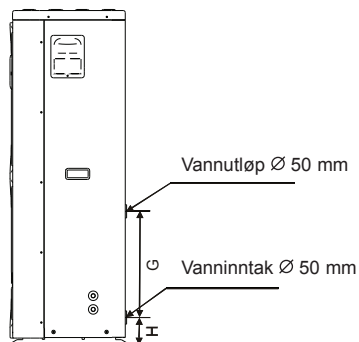

TYPE SIZE (mm)	ENP6MASC	ENP6TASC ENP7TASC
A	1138	1138
B	470	470
C	1264	1264
D	790	790
E	447	447
F	114	114
G	500	400
H	104	104

## 3. INSTALLERING OG TILKOBLING

### 3.1 Skjematisk diagram

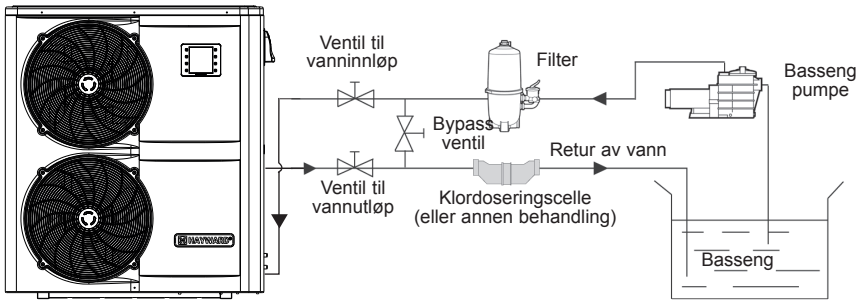

Merk: Varmepumpen er levert uten noe utstyr for behandling eller filtrering. Elementene som presenteres i diagrammer er deler som må leveres av installatøren.

### 3.2 Varmepumpe



**Plasser varmepumpen utendørs, og ikke i lukkede tekniske lokaler.**

**Plassert under beskyttelse, må minsteavstander angitt nedenfor følges for å unngå resirkulering av luft, og en degradering av varmepumpens i totale prestasjoner.**

Enhet: mm

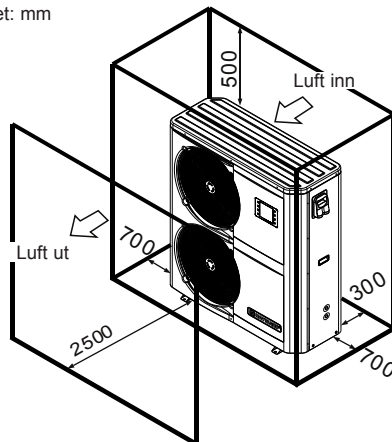

## 3. INSTALLERING OG TILKOBLING (fortsetter)

---



**Helst installere varmpumpen på en frittliggende betongplate eller spesielt feste til dette formålet, og monter varmpumpen på de medfølgende Silentbloc-underlagene (skruer og skiver ikke inkludert).**

**Maksimal avstand for installasjon mellom varmpumpen og bassenget 15 meter.**

**Total tur-retur lengde for vannkanalene 30 meter.**

**Isoler vannkanaler på bakken og under jorden.**

### 3.3 Vanntilkobling

Varmpumpen leveres med to koblingsdeler med diameter på 50 mm. Bruk PVC-rør på Ø 50 mm for vannkanaler. Koble varmpumpens vanninnløp til kanalen fra filteringsenheten, og koble deretter varmpumpens vannutløp til kanalen som går til bassenget (se diagram nedenfor).

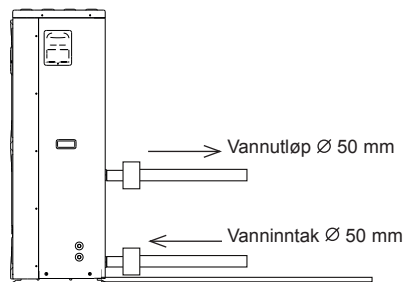

Installer en bypassventil mellom varmpumpens vanninnløp og vannutløp.



**Dersom automatisk fordeler eller klordoseringscelle benyttes, må det være installert etter varmpumpen, for å beskytte Titanium-kondensatoren mot en for stor konsentrasjon av kjemiske stoffer.**



**Sørg for å installere bypassventilen og de medfølgende koblingsdelene ved enhetens vanninnløp og vannutløp, for å forenkle tømning om vinteren, for å forenkle tilgang eller demontering for vedlikehold.**

### 3. INSTALLERING OG TILKOBLING (fortsetter)

#### 3.4 Elektrisk tilkobling



**Den elektriske installasjonen og kabling av dette utstyret må være i overensstemmelse med lokale forskrifter for installasjoner.**

F	NF C15-100	GB	BS7671:1992
D	DIN VDE 0100-702	EW	EVHS-HD 384-7-702
A	ÖVE 8001-4-702	H	MSZ 2364-702/1994/MSZ 10-553 1/1990
E	UNE 20460-7-702 1993, RECBT ITC-BT-31 2002	M	MSA HD 384-7-702.S2
IRL	Wiring Rules + IS HD 384-7-702	PL	PN-IEC 60364-7-702:1999
I	CEI 64-8/7	CZ	CSN 33 2000 7-702
LUX	384-7.702 S2	SK	STN 33 2000-7-702
NL	NEN 1010-7-702	SLO	SIST HD 384-7-702.S2
P	RSIUEE	TR	TS IEC 60364-7-702



**Kontroller at den tilgjengelige strømforsyningen og nettfrekvensen stemmer overens med operasjonelle krav, og tar hensyn til den spesifikke plasseringen til apparatet, og nødvendig strøm til å drive alle andre apparater som er koblet til samme krets.**

**ENP6MASC 230 V $\sim$  +/- 10 % 50 Hz 1 Phase**

**ENP6TASC 400 V $\sim$  +/- 10 % 50 Hz 3 Phases**

**ENP7TASC 400 V $\sim$  +/- 10 % 50 Hz 3 Phases**



**Sjekk at faselikevekten ikke overskrider 2%**

**Følg tilsvarende koblingsskjema i vedlegg.**

**Koblingsboksen ligger på enhetens høyre side. Tre tilkoblinger er til strømforsyning, og to til å styre filtreringspumpen (servomekanisme).**

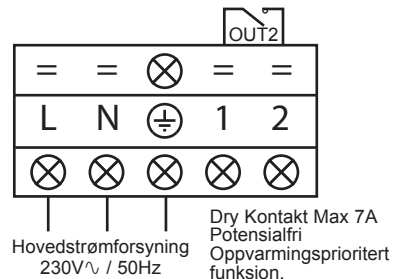
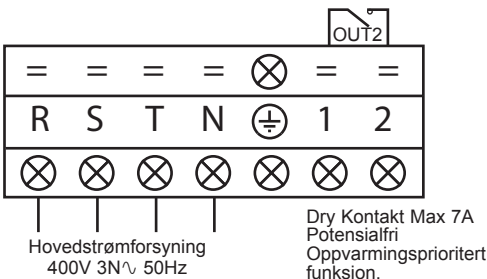

### 3. INSTALLERING OG TILKOBLING (fortsetter)

---



**Strømledningen skal være utstyrt med en sikring av typen aM eller en effektbryter Kurve D, samt en 30mA jordfeilbryter (se tabell nedenfor).**

Modeller		ENP6MASC	ENP6TASC	ENP7TASC
Elektrisk strømforsyning	V/Ph/Hz	230V ~ 50Hz	400V 3N ~ 50Hz	400V 3N ~ 50Hz
Sikringsstørrelse av typen aM	A	20 aM	12 aM	16 aM
Effektbryter Kurve D	A	20 D	12 D	16 D
Kabelseksjon	mm <sup>2</sup>	3G6 3 x 6	5G2,5 5 x 2,5	5G2,5 5 x 2,5



**Bruk en kabel av typen RO 2V / R 2V eller tilsvarende.**



**Kabelseksjonene er gitt for en lengde på maksimalt 25 meter. De må allikevel kontrolleres og tilpasses de gjeldene installasjonsforholdene.**



**Pass alltid på å stanse hovedstrømforsyningen før du åpner den elektriske kontrollboksen.**

#### 3.5 Førstegangs oppstart

Oppstartsprosedyre - når installasjonen er fullført bør du gjøre følgende:

- 1) Roter viften for hånd for å sikre at den kan rotere fritt for hånd, og at spiralen er riktig festet til motorakselen.
- 2) Se til at enheten er riktig tilkoblet til hovedstrømforsyningen (se koblingskjema i vedlegg).
- 3) Slå på filtreringspumpen.
- 4) Se til at alle vannventiler er åpne og at vannet renner inn i enheten før varme eller avkjøling skrur på.
- 5) Sjekk at kondensutløpet er festet riktig og er fri for blokkeringer.
- 6) Aktiver enhetens strømforsyning og trykk på On/Off-knappen  på kontrollpanelet.



### 3. INSTALLERING OG TILKOBLING (fortsetter)

---

- 7) Se til at ingen alarmkode vises når enheten er på (se veiledning for feilsøking).
- 8) Fastsett vannstrømmen ved hjelp av bypassventilen (se kapittel 3.6 og 2.1), som angitt for hver modell, slik at du oppnår en temperaturforskjell på 2 °C mellom vanninnløp og vannutløp.
- 9) Etter den har stått på noen minutter, sjekk at luften som kommer ut av enheten er kjøligere (mellom 5-10 °C).
- 10) Slå av filtreringspumpen mens enheten er i drift. Enheten skrur også av automatisk og viser feilkoden E03.
- 11) La enheten og filtreringspumpen stå på hele døgnet helt til ønsket vanntemperatur er nådd. Enheten slås av når gitt temperatur for vanninnløp er nådd. Enheten vil nå automatisk restarte (så lenge filtreringspumpen er på) når vanntemperaturen blir 2 °C mindre enn angitt temperatur.

**Vannsirkulasjonsbryter** - Enheten er utstyrt med en bryter som aktiverer varmpumpen når filtreringspumpen er på, og skrur den av når pumpen skrur av. Ved mangel på vann, vises alarmkoden E03 på kontrolleren (Se kapittel 6.4).

**Tidsforsinkelse** - enheten er utstyrt med en innebygd 3-minutters omstartsforsinkelse for å beskytte kontrollkretsens deler og for å fjerne omstartssyklus og støy. Denne tidsforsinkelsen vil automatisk omstarte enheten ca. 3 minutter etter hver avbrytelse av kontrollkretsen. Selv et kort strømavbrudd vil aktivere tidsforsinkelsen og forhindre enheten fra å starte før nedtellingen på 3 minutter er over.

**Fasekontroller** - Enheter med trefaset forsyning inneholder en fasekontroller som sørger for at kompressoren går rundt riktig vei. Dersom enheten ikke starter, må du sjekke om fasekontrolleren i strømboksen er i stand.

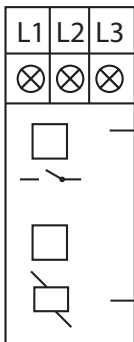

Gul/oransje ON = Relé ON = Faserekkefølge og faseantall er OK

Grønn = På

### 3. INSTALLERING OG TILKOBLING (fortsetter)

---

#### 3.6 Innstilling av vannstrømmen

Ventilene for vanninnløp og vannutløp er åpne, juster bypassventilen for å få en temperaturforskjell på 2 °C mellom vanninnløp og vannutløp (se skjematisk diagram kapittel 3.1). Du kan kontrollere innstillingen ved å se på temperaturene for innløp/utløp direkte på kontrollpanelet.

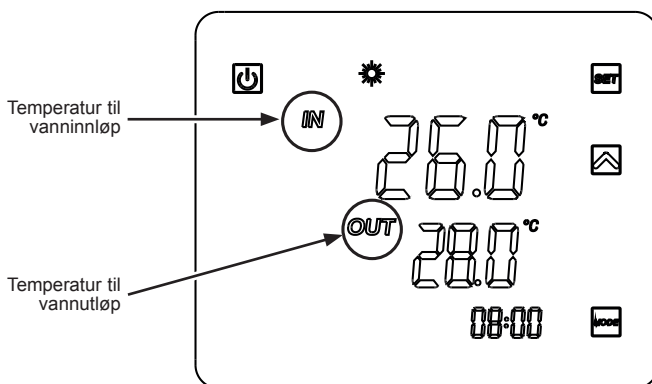

**Merk:** Åpningen av bypassventilen genererer en mindre viktig strømning eller økt  $\Delta T$ .

Lukking av bypassventilen genererer en sterkere strømning, eller en nedgang i  $\Delta T$ .

## 4. BRUKERGRENSESNITT

### 4.1 Oversikt

Varmepumpen er utstyrt med et digitalt kontrollpanel med berørings-skjerm, elektrisk tilkoblet og forhåndsinnstilt i fabrikk til varmedrift.

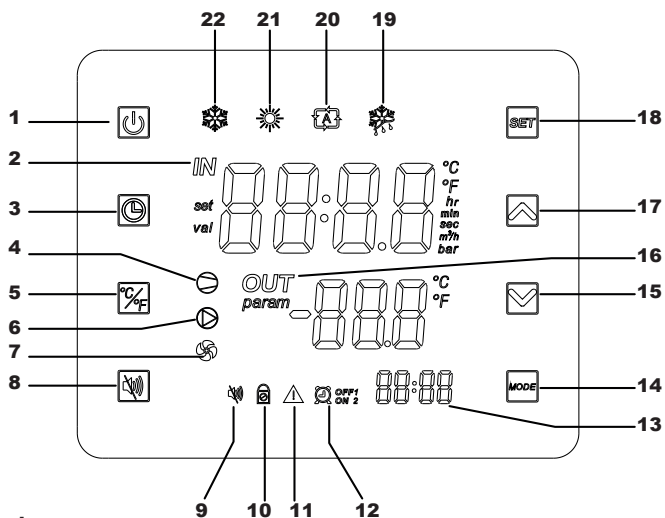

#### Tegnforklaring

1		On/Off
2		Vanninnløp
3		Innstilling av tid og Timer
4		Kompressor ON
5		Konvertering °C/°F
6		Tørr kontakt OUT2
7		Fan ON
8		Silence-modus
9		Indikator for Silence-modus
10		Låst skjerm
11		Alarm

12		Timers 1 og 2
13		Timers Klokkeslett
14		Valg av modus
15		Nedover / Minske
16		Vannutløp
17		Oppover / Øke
18		Lagre / Innstillinger
19		Tine modus
20		Automatisk modus
21		Oppvarmings modus
22		Kjøle modus

## 4. BRUKERGRENSESNITT (fortsetter)

---

### OFF-modus

Når varmepumpen er i standby (OFF-modus) vil teksten "OFF" vises på kontrollskjermen.

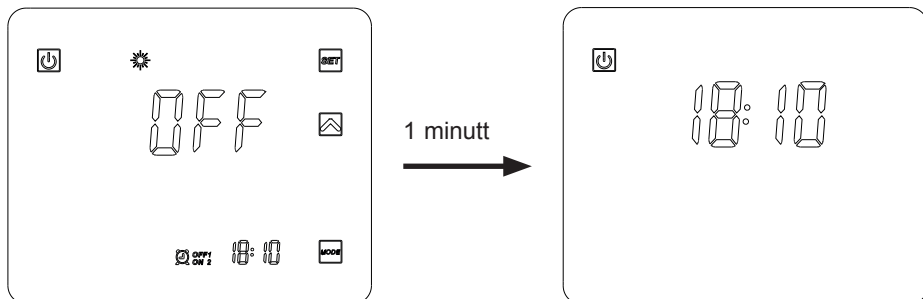

### ON-modus

Når varmepumpen er i drift eller under innstilling (ON-modus) vil temperaturer for vanninnløp og vannutløp vises på kontrollskjermen.

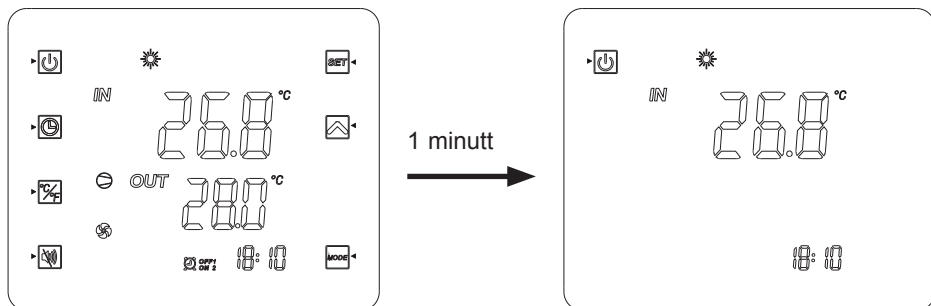









## 4. BRUKERGRENSESNITT (fortsetter)

På slutten av innstillingene, trykker du på  bekrefte.  
Opptakstillinger automatisk etter 20-årene uten handling.

### 4.2 Innstilling av tid

Hvis displayet står i standby-modus, trykk lett på knappen .









- 1) Trykk på  for få frem symbolet .
- 2) Trykk på , klokkeslettet begynner å blinke. Still timetallet ved hjelp av knappene  .
- 3) Trykk på  og still minuttene ved hjelp av knappene  .
- 4) Bekreft ved å trykke på .

### 4.3 Innstilling av Timer











Du stiller inn på denne funksjonen hvis du ønsker å sette varmpumpen i drift i løpet av en kortere periode enn den som er fastsatt av filtreringstimeren. Slik kan du programmere en forsinket start og en tidligere stans, eller rett og slett forby en tidsinnstilling for drift (for eksempel om natten).

Du kan programmere 2 Start-timere (ON1 og ON2) og 2 Stopp-timere (OFF1 og OFF2).

#### Programmere Timer 1 – Start

- 1) Trykk på  i 2 sekunder, Timeren ON1  blinker (\*).
- 2) Trykk på  for å stille timene ved hjelp av knappene  .
- 3) Trykk på  for å stille minuttene ved hjelp av knappene  .
- 4) Bekreft ved å trykke på .

#### Programmere Timer 1 – Stopp



- 1) Trykk på  i 2 sekunder, Timeren ON1  blinker (\*).  
Trykk 1 gang på , timeren OFF1  blinker.
- 2) Trykk på  for å stille timene ved hjelp av knappene  .
- 3) Trykk på  for å stille minuttene ved hjelp av knappene  .
- 4) Bekreft ved å trykke på .

(\*) For å komme direkte på Timer ON2 , trykk  i 2 sekunder, og trykk 2 ganger på .

## 4. BRUKERGRENSESNITT (fortsetter)

### Programmering av Timer 2

Etter å ha justert Timer 1, kommer du direkte til innstillingene av Timer 2:

  $ON_2$  og   $OFF_2$ . Gå fram på samme måte som for Timer 1.

**Nota:** For å komme direkte på Timer ON2 , trykk  i 2 sekunder, og trykk 2 ganger på .

### Sletting av Timere (Start og Stopp)

1) Trykk på  i 2 sekunder, Timeren ON1  blinker (\*).

2) Trykk på , klokkeslettet begynner å blinke.



3) Trykk på  for å slette Timeren .



4) Trykk på  for å bekrefte.

5) Trykk på  i 2 sekunder, Timeren ON1  blinker.

Trykk 1 gang på , ITimeren  blinker. (\*)

6) Trykk på , klokkeslettet begynner å blinke.

7) Trykk på  for å slette Timeren .

(\*) For å komme til Timer 2 eller  og , følg punkt 1) eller 4) og trykk 2 ganger på . Gå fram på samme måte som ovenfor.

### 4.4 Valg av driftsmodus: kjøling, oppvarming eller auto

#### i modus “OFF” eller “ON”

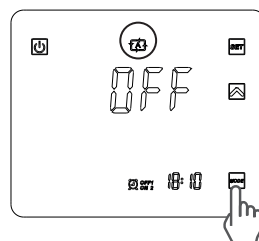
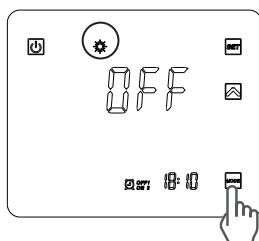
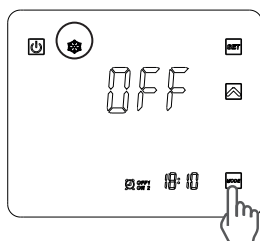

Trykk på  knappen for å bytte modus: kjøling, oppvarming eller auto.



**Hvis varmepumpen er satt i oppvarming bare eller kjølemodus, er ikke mulig skifte av modus.**



## 4. BRUKERGRENSESNITT (fortsetter)

### 4.5 Innstilling og visning av settpunkt (ønsket vanntemperatur)

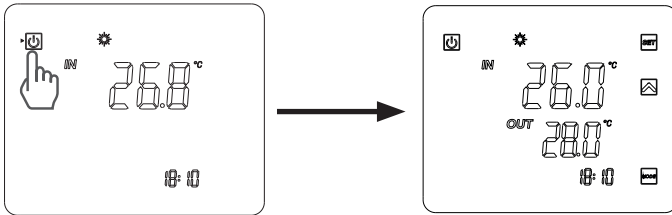
Hvis  knappen ikke er synlig på displayet, trykk lett på . (Enten utstyret er på eller av, er det nok å trykke på knappen  for å se settpunktet.)



#### I modus “OFF” og Modus “ON”





Trykk på knappen  for å vise settpunktet, og trykk deretter på  eller  for å registrere et ønsket settpunkt.

Innstillingen foretas med en nøyaktighet på 0,5 °C.



**Det anbefales å ikke overstige en temperatur på 30 °C for å unngå forandring i basseng-liners.**

### 4.6 Låse og låse opp berøringsskjermen

Trykk på tasten  i 5 sek. til det høres et pipesignal, og symbolet  vises. For å låse opp, trykk  i 5 sek. til det høres et pipesignal, og symbolet  vises.

## 4. BRUKERGRENSESNITT (fortsetter)

### 4.7 Innstilling av funksjon SILENCE (🔇)

Denne funksjonen gjør at varmepumpen kan brukes med redusert viftehastighet på 600 omdreininger/min for ENP6MASC, 830 omdreininger/min for ENP6TASC og 800 omdreininger/min for ENP7TASC i maksimalt 8 timer, noe som gjør at man kan redusere sjenerende støy om natten eller om dagen i forhold til hvor den er plassert med hensyn til naboer eller til bassenget.



Denne funksjonen kan aktiveres/deaktiveres enten manuelt eller ved hjelp av en tidtaker.

#### Manuell aktivering

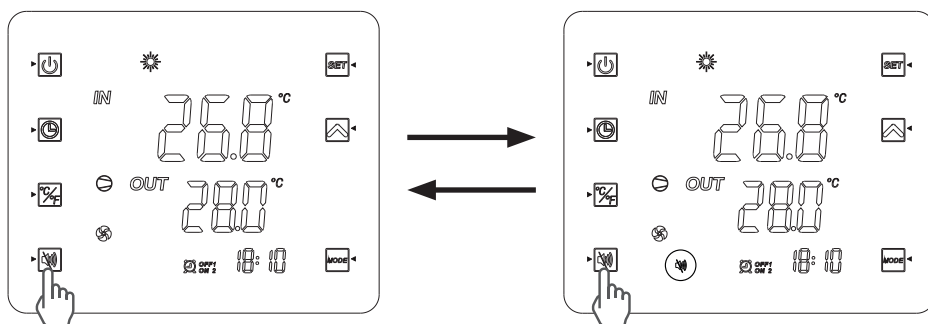
- 1) Trykk på knappen .
- 2) Bildet nedenfor vises på skjermen, Silence-modusen er aktivert for de følgende 8 timene.
- 3) Viftene reduseres gradvis hastigheten en periode på 8 timer.
- 4) Etter 8 timers drift blir funksjonen automatisk slått av og viftehastigheten vil gjenoppta funksjon av utetemperaturen.



#### Manuell deaktivering

- 1) Trykk på knappen .
- 2) Skjermen indikerer  som vist nedenfor, stille-modus er deaktivert.
- 3) Viftene tilplasser viftehastigheten etter utetemperaturen.



## 4. BRUKERGRENSESNITT (fortsetter)



### Programmering av STILLE-modus

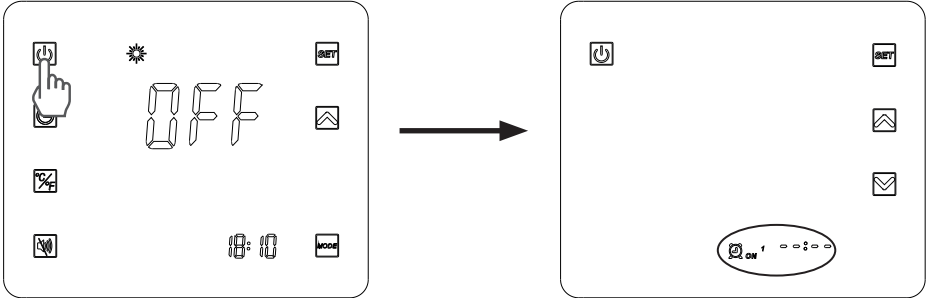

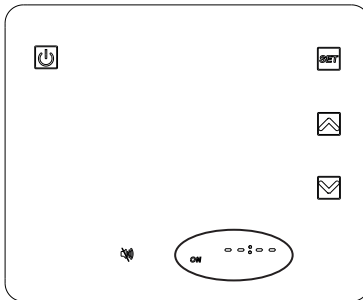

1) Trykk på  i 2 sekunder, Timeren ON1  ON <sup>1</sup> blinker.



2) Trykk 4 ganger på  til du kommer til displayet avbildet nedenfor.



3) Trykk på , klokkeslettet begynner å blinke. Bruk pilene   for å stille inn timetallet for oppstart.





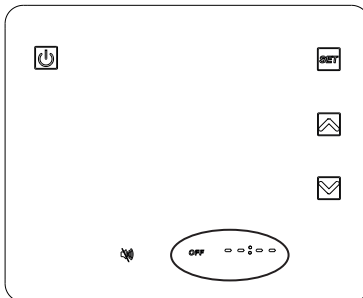



4) Trykk på , minuttene blinker. Bruk pilene   for å stille inn minuttene for oppstart. Bekreft ved å trykke på .

5) Trykk på  for å stille inn stopptiden: ordet OFF blinker.



## 4. BRUKERGRENSESNIITT (fortsetter)

---

- 6) Trykk på , klokkeslettet begynner å blinke. Bruk pilene   for å stille inn timetallet for stopptiden.
- 7) Trykk på , minuttene blinker. Bruk pilene   for å stille inn minuttene for stopptiden. Bekreft ved å trykke på .
- 8) Trykk på  for å komme tilbake til forrige skjerm. ON-OFF vises slik som herunder avbildet.

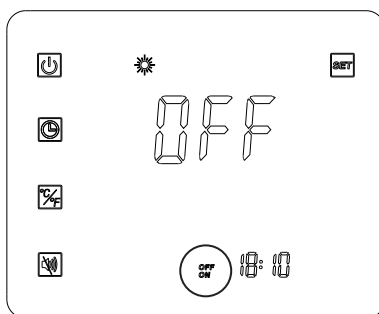

**Nota :** Ikke stilt inn minuttene og fra 10 til 10.

Når modusinnstillingen SILENCE er fullført, er den aktivert som standard 7d/7d.

## 5. VEDLIKEHOLD OG VINTERKLARGJØRING

---

### 5.1 Vedlikehold

Disse vedlikeholdsoperasjonene må utføres en gang i året for å sikre lang levetid og god drift av varmpumpen.

- Rengjør fordampere med en myk børste eller med en luft- eller vannstråle (**NB! Bruk aldri høytrykksspyler**).
- Kontroller evakuering av kondensat.
- Kontroller at elektriske og hydrauliske koblinger sitter godt
- Kontroller vann tettheten til kondensatoren.



***Før alt vedlikehold må varmpumpen være frakoblet alle strømkilder. Vedlikeholdsoperasjoner skal bare utføres av personell som er kvalifisert til å håndtere kuldemedier.***

### 5.2 Vinterklargjøring

- Sett varmpumpen i "OFF"-modus.
- Slå av varmpumpens strømforsyning.
- Tøm kondensatoren ved hjelp av tømmeventilen for å unngå fare for degradering. (høy risiko for frost).
- Lukk bypassventilen og skru løs koblingsdelene til vanninnløp/vannutløp.
- Fjern maksimalt med stillestående vann som er igjen i kondensatoren ved hjelp av en blåsepistol.
- Forsegle varmpumpens vanninnløp og vannutløp for å hindre at fremmedlegemer kommer seg inn.
- Dekk til varmpumpen med vinterbelegget som er tiltenkt dette formålet.



***Alle skader som er forårsaket av uriktig vinterklargjøring vil ugyldiggjøre garantien.***

# 6. VEDLEGG

## 6.1 Koblingsskemaer

### ENP6MASC

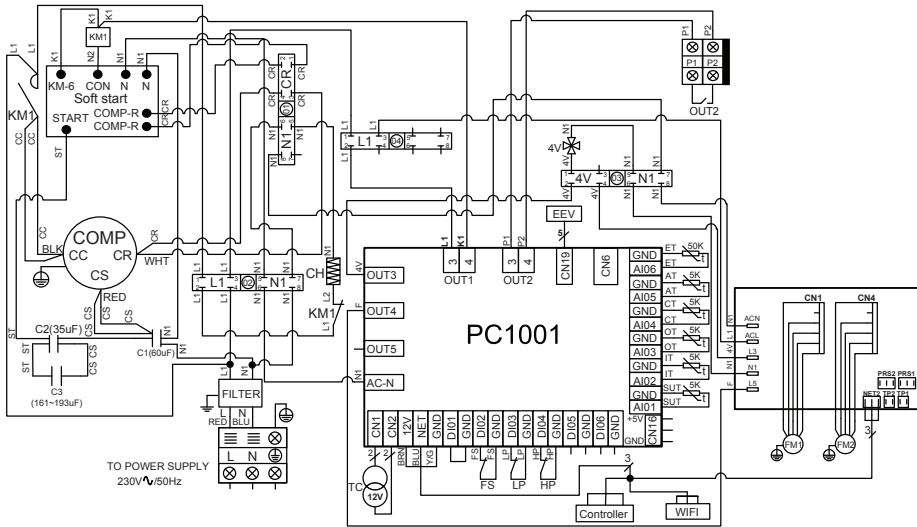

#### MERKNADER:

1. AT : SENSOR FOR LUFTTEMPERATUR
2. COMP : KOMPRESSOR
3. CT : SENSOR FOR FORDAMPET TEMPERATUR
4. EEV : ELEKTRONISK EKSPANSJONSVENTIL
5. FM1-2 : VIFTEMOTOR
6. FS : VANNSENSOR
7. HP : HØYTRYKKSBRUYTER
8. IT : TEMPERATURSENSOR TIL VANNINNLØP
9. LP : LAVTRYKKSBRUYTER
10. OT : TEMPERATURSENSOR TIL VANNUTLØP
11. SUT : SENSOR FOR SUGETEMPERATUR
12. TC : OMFORMER 230V ~ / 12V ~
13. 4V : 4-VEIS VENTIL
14. KM1 : EFFEKTKONTAKTOR
15. SOFT STARTER : ELEKTRONISK STARTER
16. CH : BUNNKASSEVARMER
17. ET : TEMPERATURSENSOR FOR UTLADNING
18. OUT2 : POTENSIALFRI KONTAKT, MAKS. 7A

# 6. VEDLEGG (fortsetter)

## ENP6TASC - ENP7TASC

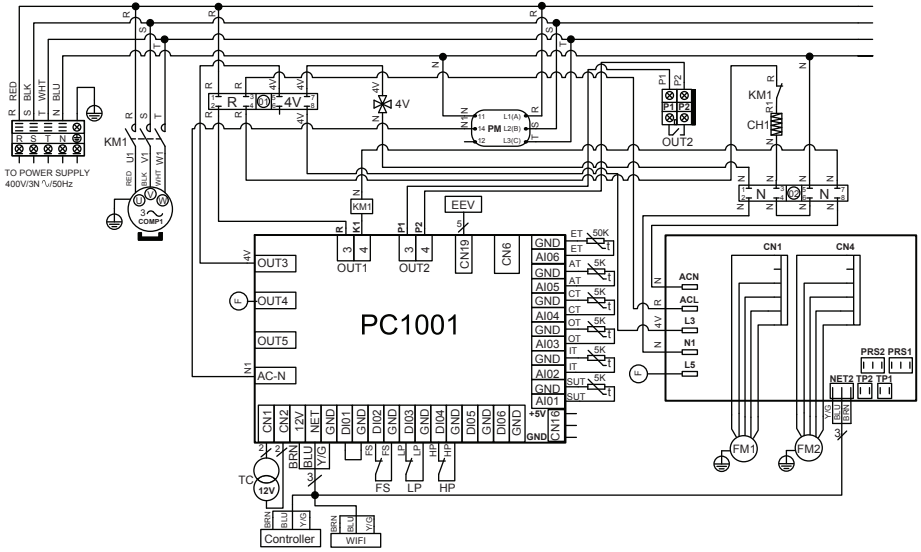

**MERKNADER:**

1. AT : SENSOR FOR LUFFTEMPERATUR
2. COMP : KOMPRESSOR
3. CT : SENSOR FOR FORDAMPET TEMPERATUR
4. EEV : ELEKTRONISK EKSPANSJONSVENTIL
5. FM1-2 : VIFTEMOTOR
6. FS : VANNSENSOR
7. HP : HØYTRYKKSRYTER
8. IT : TEMPERATURSENSOR TIL VANNINNLØP
9. LP : LAVTRYKKSRYTER

10. OT : TEMPERATURSENSOR TIL VANNUTLØP
11. SUT : SENSOR FOR SUGETEMPERATUR
12. TC : OMFORMER 230V ~ / 12V ~
13. 4V : 4-VEIS VENTIL
14. KM1 : EFFEKTKONTAKTOR
15. PM : FASEKONTROLLER
16. CH1 : BUNNKASSEVARMER
17. ET : TEMPERATURSENSOR FOR UTLADNING
18. OUT2 : POTENSIALFRI KONTAKT, MAKS. 7A

## 6. VEDLEGG (fortsetter)

### 6.2 Kobling med prioritet på trefaset varmpumpe

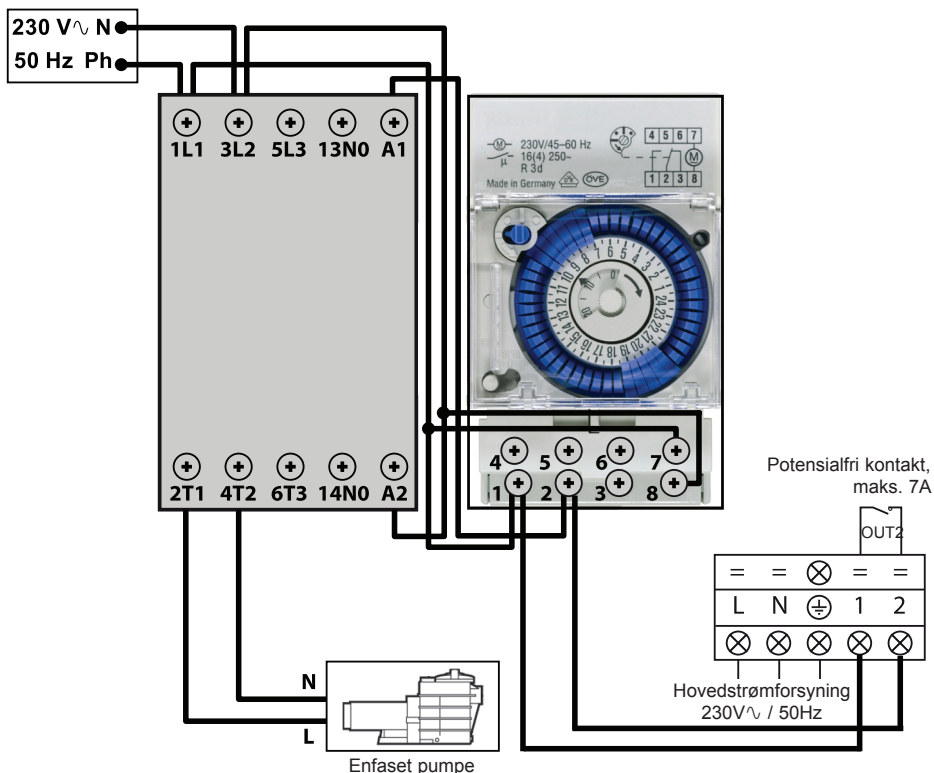

“Terminalene 1 og 2 gir et tørt kontaktpotensial uten polaritet 230 V~/ 50 Hz.

Kabling til klemmene 1 og 2 i samsvar med ledningene beskrevet ovenfor, for å kontrollere driften av pumpen ved filtrering syklus 2 min hver time hvis temperaturen i tanken er under det innstilte punktet. “

 Aldri koble strømtilførselen til filterpumpen direkte på terminalene 1 og 2.



## 6. VEDLEGG (fortsetter)

### 6.2 Kobling med prioritet på trefaset varmepumpe

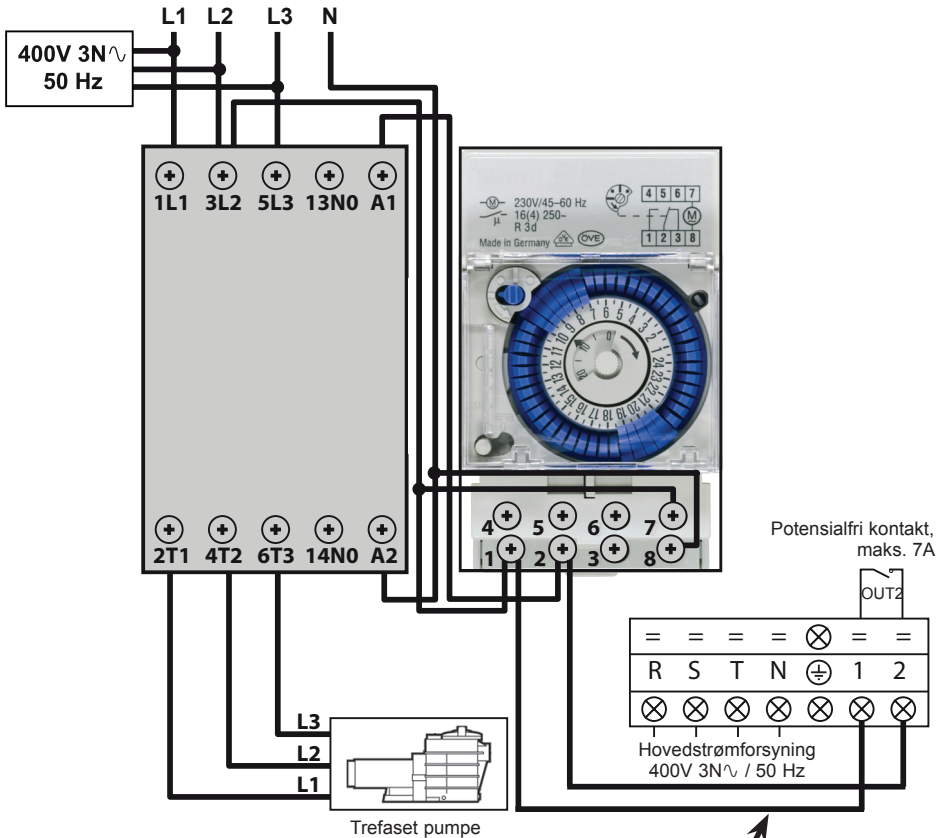

“Terminalene 1 og 2 gir et tørt kontaktpotensial uten polaritet 230 V $\sim$  / 50 Hz.

Kabling til klemmene 1 og 2 i samsvar med ledningene beskrevet ovenfor, for å kontrollere driften av pumpen ved filtrering syklus 2 min hver time hvis temperaturen i tanken er under det innstilte punktet. “

 Aldri koble strømtilførselen til filterpumpen direkte på terminalene 1 og 2.



## 6. VEDLEGG (fortsetter)

### 6.3 Sprengskisse og reservedeler

#### ENP6MASC

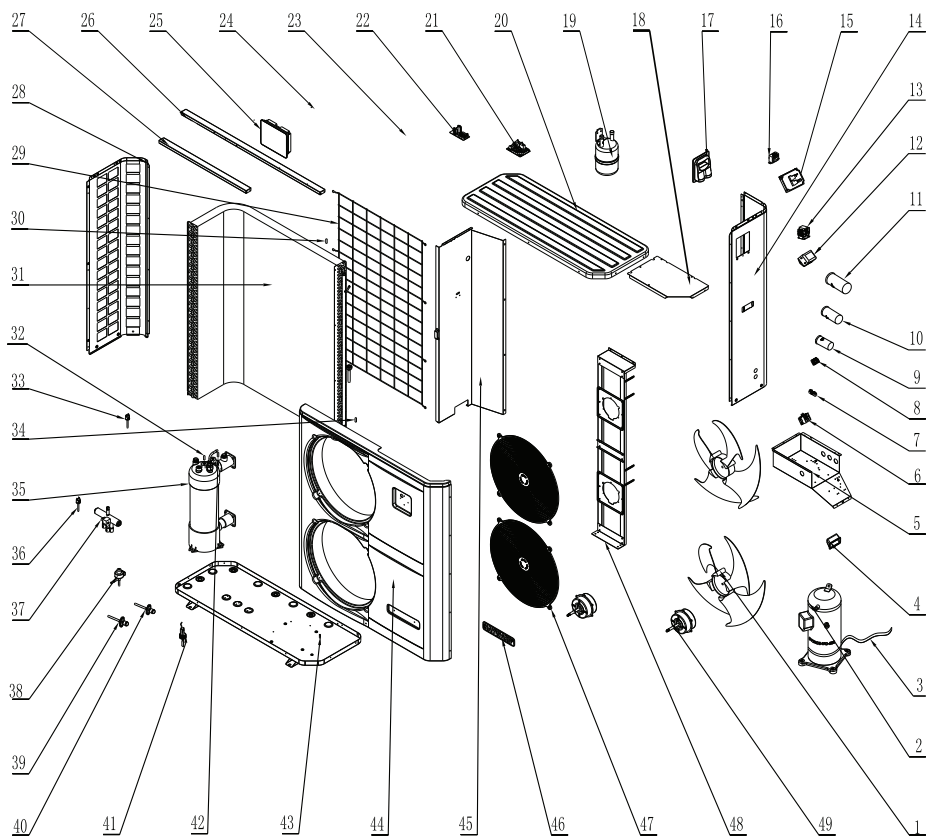



## 6. VEDLEGG (fortsetter)

### ENP6MASC

Nr.	Ref.	Betegnelse	Nr.	Ref.	Betegnelse
1	HWX20000270004	Vifteproprell	28	HWX32019210028	Venstre panel
2	HWX200011112	Kompressor	29	HWX32019210031	Fordamperbeskyttelse
3	HWX20003214	Bunnkassevarmer	30	HWX20003242	Lufttemperaturmåler
4	HWX32008220037	Håndtak	31	HWX32010120008	Fordamper
5	HWX32019210040	Strømboks	32	HWX20003242	Sensor til vanninnløp
6	HWX20003920	Terminal med 3 koblinger	33	HWX20013605	Høytrykksbryter
7	HWX20003909	Terminal med 2 koblinger	34	HWX20003242	Sensor for fordampert temperatur
8	HWX20003933	Terminal med 3 koblinger	35	HWX32010120023	Kondensator Titanium PVC
9	HWX20003504	Kompressorkondensator (35µF)	36	HWX20003603	Lavtrykksbryter
10	HWX20003510	Kompressorkondensator (60µF)	37	HWX20011491	4-veis ventil
11	HWX20000350011	Startkondensator (193µF)	38	HWX20000140346	Elektronisk ekspansjonsventil
12	HWX20003254	EMC filter	39	HWX20000140353	Trykkran H&L
13	HWX200036007	Kompressorkontaktor mono	40	HWX20000140353	Trykkran H&L
14	HWX32010210013	Høyre panel	41	HWX200036005	Sensor for vannstrømning
15	HWX20003151	Elektronisk starter	42	HWX20003242	Sensor til vannutløp
16	HWX200037003	Transformator 230V <sub>~</sub> - 12V <sub>~</sub>	43	HWX32019210061	Bunn
17	HWX32009220032	Deksel for elektrisk tilgang	44	HWX32019210049	Frontpanel
18	HWX32019210025	Panel til elektrisk beskyttelse	45	HWX32019210026	Skillepanel
19	HWX20001440	Væskebeholder	46	HWX20000230596	Hayward-logo
20	HWX32019220001	Øvre panel	47	HWX20000220169	Beskyttelsesgitter for viften
21	HWX95053114512E	Elektronisk kort	48	HWX32019210022	Motorstøtte
22	HWX950531024103	Likestrømsinvertermodul	49	HWX20000330132	Likestrømsmotor
*23*	HWX20003223	kompressor probe 50kΩ	*50*	HWX20002625	Anti-vibrasjonsmontering
24	/	/	*51*	HWX200026009	O-ring ID 43-tykkelse 3.4 mm
25	HWX95005010018	LED-regulator	*52*	HWX200026061	O-ring ID 48-tykkelse 5 mm
26	HWX32019210030	Stor stiver	*53*	HWX20000240112	Vinterkledning
27	HWX32019210029	Liten stiver	*54*	HWX20001345	Tappeplugg

Merknad: \* xx \* merkene er ikke referert til i tilsvarende deleetegninger.

## 6. VEDLEGG (fortsetter)

### 6.3 Sprengskisse og reservedeler

#### ENP6TASC

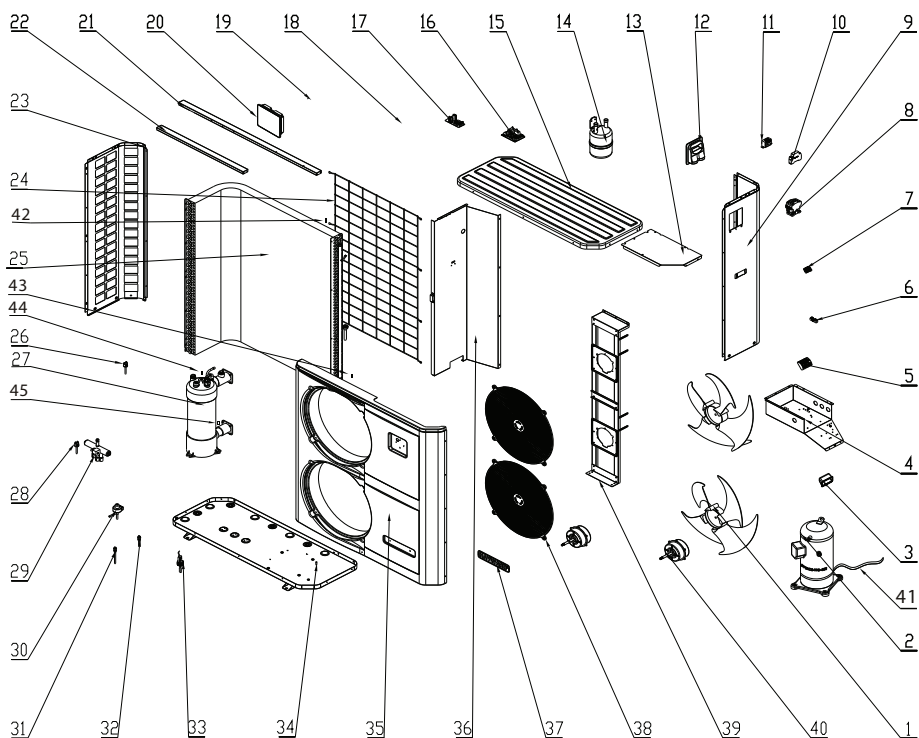

## 6. VEDLEGG (fortsetter)

### ENP6TASC

Nr.	Ref.	Betegnelse	Nr.	Ref.	Betegnelse
1	HWX20000270004	Vifteproprell	26	HWX20013605	Høytrykksbryter
2	HWX20000110146	Kompressor	27	HWX32019120007	Kondensator Titanium PVC
3	HWX32008220037	Håndtak	28	HWX20003603	Lavtrykksbryter
4	HWX32019210024	Strømboks	29	HWX20011491	4-veis ventil
5	HWX20003902	Terminal 5 tilkoblinger Tri	30	HWX20000140346	Elektronisk ekspansjonsventil
6	HWX20003909	Terminal med 2 koblinger	31		
7	HWX20003933	Terminal med 3 koblinger	32		
8	HWX20003653	Kompressorkontaktor TRI	33	HWX200036005	Detektor for vannmengde
9	HWX32019210027	Høyre panel	34	HWX32019210061	Bunnpanel
10	HWX200036023	Fasekontroller	35	HWX32019210049	Frontpanel
11	HWX200037003	Transformator 230V $\sqrt{v}$ -12V $\sqrt{v}$	36	HWX32019210026	Skillepanel
12	HWX32009220032	Deksel for elektrisk tilgang	37	HWX20000230596	Hayward-logo
13	HWX32019210025	Panel til elektrisk beskyttelse	38	HWX20000220169	Beskyttelsesgitter for viften
14	HWX20001440	Væskebeholder	39	HWX32019210022	Motorstøtte
15	HWX32019220001	Øvre panel	40	HWX20000330132	Likestrømsmotor
16	HWX95053114510E	Elektronisk kort	41	HWX20003214	Bunnkassevarmer
17	HWX950531024101	Likestrømsinvertermodul	42	HWX20003242	Lufttemperaturmåler
*18*	HWX20003223	kompressor probe 50k $\Omega$	43		Sensor for fordampet temperatur
19	/	/	44		Sensor til vanninnløp
20	HWX95005010018	LED-regulator	45		Sensor til vannutløp
21	HWX32019210030	Stor stiver	*46*	HWX20002625	Anti-vibrasjonsmontering
22	HWX32019210029	Liten stiver	*47*	HWX200026009	O-ring ID 48-tykkelse 5 mm
23	HWX32019210028	Venstre panel	*48*	HWX200026061	O-ring ID 43-tykkelse 3,4 mm
24	HWX32019210031	Fordamperbeskyttelse	*49*	HWX20000240112	Vinterkledning
25	HWX32010120008	Fordamper	*50*	HWX20001345	Tappeplugg

Merknad: \* xx \* merkene er ikke referert til i tilsvarende deleetegninger.

## 6. VEDLEGG (fortsetter)

ENP7TASC

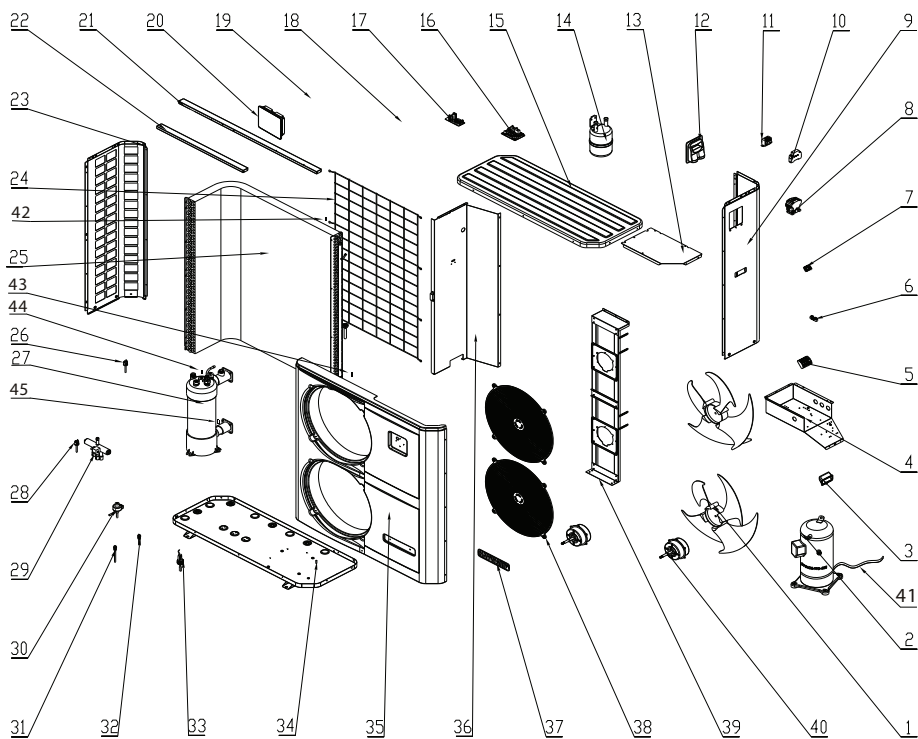

## 6. VEDLEGG (fortsetter)

### ENP7TASC

Nr.	Ref.	Betegnelse	Nr.	Ref.	Betegnelse
1	HWX20000270004	Viftepropell	26	HWX20013605	Høytrykksbryter
2	HWX20000110138	Kompressor	27	HWX32019120007	Kondensator Titanium PVC
3	HWX32008220037	Håndtak	28	HWX20003603	Lavtrykksbryter
4	HWX32019210024	Strømboks	29	HWX20011491	4-veis ventil
5	HWX20003902	Terminal 5 tilkoblinger Tri	30	HWX20000140398	Elektronisk ekspansjonsventil
6	HWX20003909	Terminal med 2 koblinger	31		
7	HWX20003933	Terminal med 3 koblinger	32		
8	HWX20003653	Kompressorkontaktor TRI	33	HWX200036005	Sensor for vannstrømning
9	HWX32019210027	Høyre panel	34	HWX32019210061	Bunnpanel
10	HWX200036023	Fasekontroller	35	HWX32019210049	Frontpanel
11	HWX200037003	Transformator 230V $\sqrt{v}$ -12V $\sqrt{v}$	36	HWX32019210026	Skillepanel
12	HWX32009220032	Deksel for elektrisk tilgang	37	HWX20000230596	Hayward-logo
13	HWX32019210025	Panel til elektrisk beskyttelse	38	HWX20000220169	Beskyttelsesgitter for viften
14	HWX20001440	Væskebeholder	39	HWX32019210022	Support Moteur
15	HWX32019220001	Øvre panel	40	HWX20000330132	Likestrømsmotor
16	HWX95053114511E	Elektronisk kort	41	HWX20003214	Bunnkassevarmer
17	HWX950531024102	Likestrømsinvertermodul	42	HWX20003242	Lufttemperaturmåler
*18*	HWX20003223	kompressor probe 50k $\Omega$	43		Sensor for fordampet temperatur
19	/	/	44		Sensor til vanninnløp
20	HWX95005010018	LED-regulator	45		Sensor til vannutløp
21	HWX32019210030	Stor stiver	*46*	HWX20002625	Anti-vibrasjonsmontering
22	HWX32019210029	Liten stiver	*47*	HWX200026009	O-ring ID 48-tykkelse 5 mm
23	HWX32019210028	Venstre panel	*48*	HWX200026061	O-ring ID 43-tykkelse 3,4 mm
24	HWX32019210031	Fordamperbeskyttelse	*49*	HWX20000240112	Vinterkledning
25	HWX32019120002	Fordamper	*50*	HWX20001345	Tappeplugg

Merknad: \* xx \* merkene er ikke referert til i tilsvarende deletegninger.

## 6. VEDLEGG (fortsetter)

---

### 6.4 Veiledning for feilsøking



*Enkelte operasjoner må utføres av en kvalifisert tekniker.*

I tilfelle feil, vil følgende meldinger vises på skjermen:

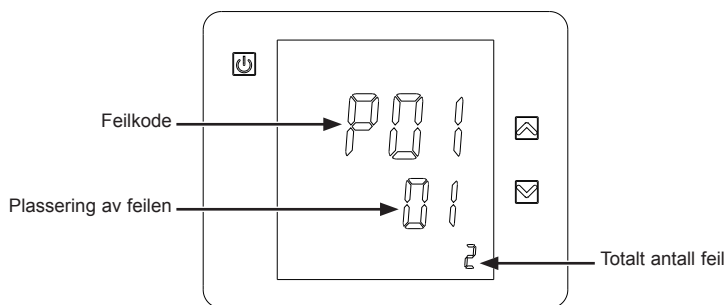

Hvis det oppstår flere feil, trykk på  eller  for å bla fra den ene feilkoden til den neste. Se tabellen lenger ned.

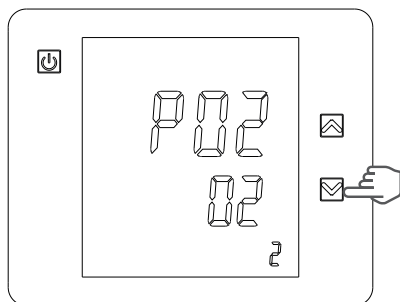

## 6. VEDLEGG (fortsetter)

Feil	Feilkoder	Beskrivelse	Løsning
Feil i temperatursensor til vanninnløp	P01	Sensoren er åpen eller det er en kortslutning.	Sjekk eller skift ut sensoren.
Feil i temperatursensor til vannutløp	P02	Sensoren er åpen eller det er en kortslutning.	Sjekk eller skift ut sensoren.
Feil på avrimingssensor	P05	Sensoren er åpen eller det er en kortslutning.	Sjekk eller skift ut sensoren.
Feil på sensor til utendørstemperatur	P04	Sensoren er åpen eller det er en kortslutning.	Sjekk eller skift ut sensoren.
Standard kompressoraspirasjon	P07	Sensoren er åpen eller det er en kortslutning.	Sjekk eller skift ut sensoren.
Temperaturforskjellen mellom vanninnløp og vannutløp er for stor	E06	Det er ikke nok vannsirkulasjon, forskjellen i vannsirkulasjon er for lav/for stor.	Sjekk vannsirkulasjonen, eller blokkeringer i systemet.
Tinesyklus Kjølemodus	E07	Vannutløpet er for lavt.	Sjekk vannsirkulasjonen eller vannutløpets temperatursensor.
Første nivå av frostbeskyttelse om vinteren	E19	Rom- eller innløpstemperatur er for lav.	
Andre nivå av frostbeskyttelse om vinteren	E29	Rom- eller innløpstemperatur er enda lavere.	
Høytrykksbeskyttelse	E01	Trykket i kjølekretsen er for høy, vannsirkulasjonsgraden er for lav, fordampere er tett, luftsirkulasjon er for lav.	Sjekk høytrykksbryteren og trykket i kjølekretsen. Sjekk vann- og luftsirkulasjonen. Kontroller at vannsirkulasjonsbryteren fungerer som den skal. Kontroller ventilåpninger for vanninnløp/vannutløp. Kontroller innstilling av bypass.
Lavtrykksbeskyttelse	E02	Trykket i kjølekretsen er for lavt, vannsirkulasjonsgraden er for lav eller fordampere er tett.	Sjekk lavtrykksbryteren og trykket i kjølekretsen for å vurdere om der er en lekkasje. Rengjør overflaten på fordampere. Sjekk hastigheten til vifterotasjonen. Sjekk den frie flyten av luft gjennom fordampere.
Feil i sensor for vannstrømning	E03	For lite vann, eller kortsluttet eller defekt sensor	Sjekk vannstrømmen, sjekk filteringspumpen og strømningssensoren for å se etter eventuelle defekter.
Kommunikasjonsfeil	E08	Feil i LED-kontroller eller PCB-forbindelsen.	Kontroller kabeltilkoblingene NET og NET 1.
Kompressoren starter ikke	E08	Enten mangler det en fase, eller er faserekkefølgen feil	sjekk at alle 3 faser er på plass endre faserekkefølgen i koblingsboksen på varmpumpa.

## 6. VEDLEGG (fortsetter)

---

### 6.5 Garanti

#### **GARANTIBETINGELSER**

HAYWARD garanterer at deres produkter er fri for defekter i materiale og i utførelse for en periode på to år fra innkjøpsdato. Ved evt. garantikrav, må kvittering for kjøpet fremlegges. Vi ber om at kvitteringen blir tatt vare på av kjøper.

HAYWARD garanti er, etter HAYWARD eget valg, begrenset til erstatning eller reparasjon av defekte produkter som har vært i normal bruk og behandlet i henhold til instruksjonsboken, uten at det har vært foretatt endringer av produktet, og at bare ekte HAYWARD deler har vært brukt. Skader som skyldes frost og kjemiske reaksjoner er ikke omfattet av denne garanti.

HAYWARD er ikke ansvarlig for noen andre kostnader (flytting, arbeidskostnader osv...), heller ikke for direkte eller indirekte skader som skyldes funksjonsfeil ved et produkt.

For å sette i gang et garantikrav og å be om reparasjon eller erstatning av et produkt, vennligst ta kontakt med forhandleren. Forsendelse av produkter direkte til vår fabrikk blir ikke akseptert uten vår skriftlige forhåndsgodkjenning.

Slitasjedeler omfattes ikke av garantien.



ISENPASC Rev C

# ***ENERGYLINE PRO***

**ТЕПЛОВОЙ НАСОС ДЛЯ ПЛАВАТЕЛЬНОГО БАССЕЙНА**



**Руководство по монтажу и эксплуатации**

# СОДЕРЖАНИЕ

---

<b>1. Введение</b>	<b>1</b>
<hr/>	
<b>2. Технические характеристики</b>	<b>2</b>
2.1 Технические данные теплового насоса	2
2.2 Рабочий диапазон	3
2.3 Размеры	4
<hr/>	
<b>3. Установка и подключение</b>	<b>5</b>
3.1 Принципиальная схема	5
3.2 Тепловой насос	6
3.3 Гидротехническое подключение	6
3.4 Электрическое подключение	7
3.5 Первый запуск	8
3.6 Установка пропускной способности насоса	10
<hr/>	
<b>4. Интерфейс пользователя</b>	<b>11</b>
4.1 Общие сведения	11
4.2 Установка времени	13
4.3 Настройка функции таймер	13
4.4 Выбор режима работы	14
4.5 Установка и визуализация заданного значения	15
4.6 Блокировка и разблокировка тактильного экрана	15
4.7 Настройки бесшумного режима	16
<hr/>	
<b>5. Техническое обслуживание и консервация на зиму</b>	<b>19</b>
5.1 Техническое обслуживание	19
5.2 Консервация на зиму	19
<hr/>	
<b>6. Приложения</b>	<b>20</b>
6.1 Электрические схемы	20
6.2 Включение подогрева в качестве приоритета	22
6.3 Вид в разборе и съемные элементы	24
6.4 Справочник по устранению неисправностей	30
6.5 Гарантия	32

Внимательно прочитать и сохранить для дальнейших консультаций.

Этот документ необходимо передать владельцу плавательного бассейна, чтобы он его сохранил в надежном месте.

# 1. ВВЕДЕНИЕ

---

Благодарим Вас за приобретение данного теплового насоса для плавательного бассейна производства компании Nuward. Данное изделие разработано в соответствии со строгими производственными стандартами для удовлетворения предъявляемых требований по качеству. Данное руководство включает в себя всю информацию, необходимую для установки изделия, устранения неисправностей и его технического обслуживания. Перед тем, как распаковать изделия или перед осуществлением его технического обслуживания внимательно ознакомьтесь с данным руководством. Производитель данного изделия не несет никакой ответственности за причинение травм потребителю или повреждение изделия вследствие его неправильной установки, за устранение нарушений в работе или бесполезное техническое обслуживание. Крайне важно всегда следовать инструкциям, изложенным в данном руководстве. Устройство должно быть установлено силами квалифицированного персонала.

- Ремонт должен осуществляться силами квалифицированного персонала.
- Все операции по электрическому подключению должны осуществляться квалифицированным электриком-профессионалом и в соответствии с нормами, действующими в стране, где производится установка, см. § 3.4.
- Техническое обслуживание и необходимые процедуры должны осуществляться с частотой и в сроки, определенные в настоящем руководстве.
- Используйте только оригинальные запасные части.
- Несоблюдение данных рекомендаций ведет к отмене гарантийных обязательств.
- Данный тепловой насос нагревает воду в плавательном бассейне, поддерживает постоянную температуру и не предназначен для использования в других целях.

После прочтения данного руководства держите его под рукой для дальнейшего использования.

Замечания относительно детей / людей с ограниченными физическими возможностями :

Данное изделие не предназначено для использования лицами (особенно детьми), физические, сенсорные или умственные способности которых ограничены, или лицами, не имеющими необходимого опыта или знаний, если только они не совершают этого под присмотром или не получили инструкции касательно использования изделия от лица, несущего за них ответственность.

Данное изделие содержит газ фреон, применение которого оговорено в Киотском протоколе.

Тип хладагента : R410A

Значение в рамках потенциала глобального потепления<sup>(1)</sup> : 1975

В рамках европейского или местного законодательства могут проводиться периодические проверки на предмет возможной утечки хладагента. Для получения дополнительной информации обратитесь к Вашему местному дистрибьютору.

---

(1) Возможность глобального потепления

## 2. ТЕХНИЧЕСКИЕ ХАРАКТЕРИСТИКИ

### 2.1 Технические данные теплового насоса

Модели	ENERGYLINE PRO	ENP6MASC	ENP6TASC	ENP7TASC
Теплотворная производительность *	kW	17,8	18,2	23,4
Потребляемая электрическая мощность *	kW	3,69	3,7	5,15
Рабочий ток *	A	16,2	7,69 / 6,89 / 6,33	9,71 / 8,01 / 7,70
Напряжение питания	V/Ph/Hz	230V $\sphericalangle$ 50Hz	400V 3N $\sphericalangle$ 50Hz	400V 3N $\sphericalangle$ 50Hz
Предел срабатывания предохранителя, тип aM (предохранитель для защиты электродвигателей и кабелей)	A	20	12	16
Автоматический выключатель, кривая D	A	20	12	16
Количество компрессоров		1	1	1
Тип компрессора		Scroll	Scroll	Scroll
Количество вентиляторов		2	2	2
Мощность вентилятора	Вт	50 — 225	50 — 225	50 — 225
Скорость вращения вентиляторов	об./мин.	600 — 950	830 — 960	800 — 1050
Вентиляция		Horizontal	Horizontal	Horizontal
Уровень акустического давления (на 1 м)	дБ(А)	45	45	47
Гидротехническое подключение	мм	50	50	50
Номинальная пропускная способность*	м <sup>3</sup> /час	6,6	6,6	8
Снижения давления воды (макс)	кПа	7	7	18
Чистые размеры устройства (длина/ширина/высота)	мм	1138 / 470 / 1264	1138 / 470 / 1264	1138 / 470 / 1264
Вес нетто устройства	кг	127	123	140

\* Значение +/- 5% при следующих условиях: Температура окружающей среды = 15°C (59° по Фаренгейту) / относительная влажность = 71% / Температура воды на входе = 26°C (78,8° по Фаренгейту).



Соответствие системе NF -414 (ежегодное использование).

## 2. ТЕХНИЧЕСКИЕ ХАРАКТЕРИСТИКИ

### (продолжение)

#### 2.2 Рабочий диапазон

Для обеспечения надежной и эффективной работы теплового насоса используйте его в следующих рабочих диапазонах температур и влажности.

	Режим подогрева 	Режим Охлаждение 
Температура окружающей среды	-12°C ~ +35°C	+7°C ~ +43°C
Температура воды	+12°C ~ +40°C	+8°C ~ +40°C
Относительная влажность	< 80%	< 80%
Рабочий диапазон заданного значения	+15°C ~ +32°C	+8°C ~ +32°C



***Если температура или влажность не соответствуют указанным условиям, может сработать защитное устройство, и тогда тепловой насос может отключиться.***



***Максимальная температура нагрева ограничена до 32°C во избежание повреждения покрытия. Фирма Nauward не несет ответственности в случае эксплуатации при температуре выше 32°C.***

## 2. ТЕХНИЧЕСКИЕ ХАРАКТЕРИСТИКИ

### (продолжение)

### 2.3 Размеры

Модели : ENP6MASC / ENP6TASC / ENP7TASC

Устройство : мм

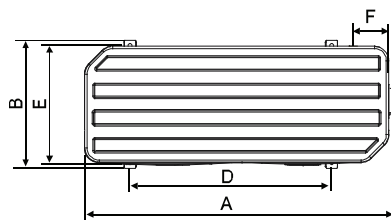
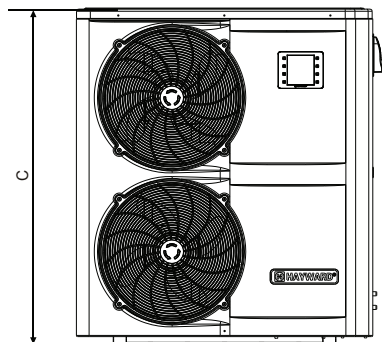
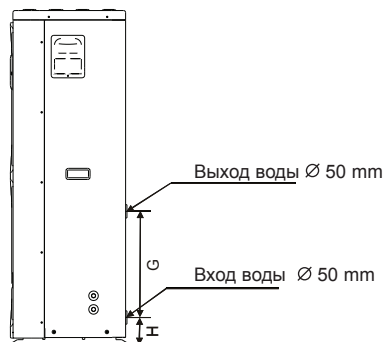

TYPE SIZE (MM)	ENP6MASC	ENP6TASC ENP7TASC
A	1138	1138
B	470	470
C	1264	1264
D	790	790
E	447	447
F	114	114
G	500	400
H	104	104

## 3. УСТАНОВКА И ПОДКЛЮЧЕНИЕ

### 3.1 Принципиальная Схема

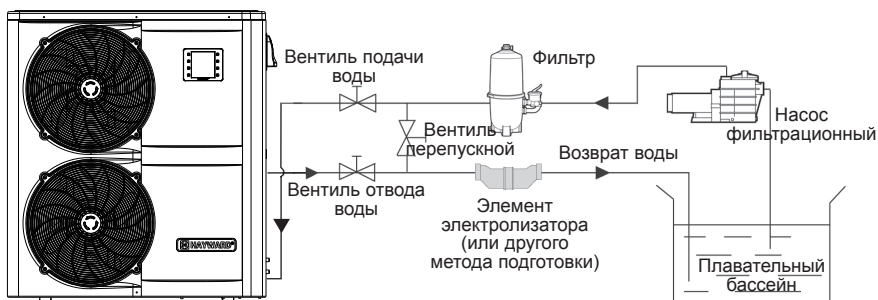

Примечание : Тепловой насос поставляется без какого-либо дополнительного оборудования для подготовки или фильтрации воды. Представленные на схеме элементы поставляются фирмой, осуществляющей установку.

### 3.2 Тепловой насос



**Разместите тепловой насос на открытом воздухе, отдельно от любого другого закрытого оборудования.**

**Разместите его под навесом, с соблюдением всех указанных минимальных расстояний до других предметов, чтобы избежать всех рисков, связанных с рециркуляцией воздуха и возможного отрицательного влияния теплового насоса на состояние окружающей среды.**

Устройство : мм

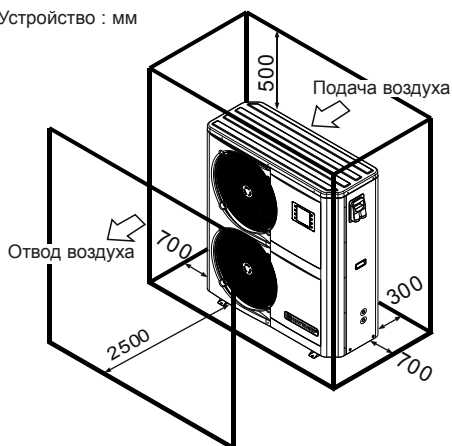

### 3. УСТАНОВКА И ПОДКЛЮЧЕНИЕ (продолжение)



*Желательно установить тепловой насос на отдельной бетонной площадке или в другом предусмотренном для этого месте, с использованием входящих в комплект поставки сайлентблоков (болты и шайбы в комплект поставки не входят).*

*Максимальное расстояние между тепловым насосом и плавательным бассейном не должно превышать 15 м.*

*Общая длина шлангов подачи и отвода воды не должна превышать 30 м.*

*Изолировать шланги от поверхности земли и не закапывать.*

#### 3.3 Гидротехническое подключение

Тепловой насос поставляется с двумя штуцерными соединениями диаметром 50 мм с накидной гайкой. Для подвода воды используйте ПВХ шланги Ø 50 мм. Соедините входное отверстие для воды теплового насоса со шлангом, ведущим к фильтрационному блоку, затем соедините выходное отверстие для воды теплового насоса со шлангом, подающим воду в бассейн (см. приведенную ниже схему).

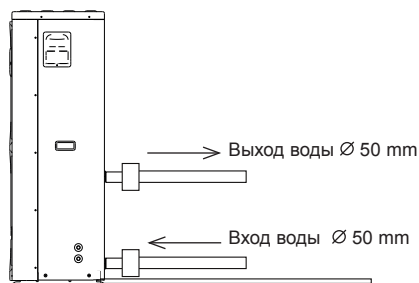

Установите так называемый "перепускной" вентиль между входным и выходным отверстиями теплового насоса.



*Если используются автоматическое питательное устройство или электризатор, они должны быть установлены непосредственно после теплового насоса с целью предохранения конденсатора Titane от чрезмерного накопления в нем химических продуктов.*



*Постарайтесь установить перепускной вентиль и поставляемые штуцерные соединения на одном уровне с входом и выходом воды на устройстве, чтобы упростить спуск воды на зимний период, облегчив таким образом доступ к элементам и демонтаж на период технического обслуживания.*



### 3. УСТАНОВКА И ПОДКЛЮЧЕНИЕ (продолжение)

#### 3.4 Электрическое Подключение



**Электроподключение и все соединения данного оборудования должны соответствовать местным действующим правилам установки.**

Франция	NF C15-100	Великобритания	BS7671:1992
Дания	DIN VDE 0100-702	Англия и Уэльс	EVHS-HD 384-7-702
А	ÖVE 8001-4-702	Венгрия	MSZ 2364-702/1994/MSZ 10-553 1/1990
Испания	UNE 20460-7-702 1993, RECBT ITC-BT-31 2002	Мэн	MSA HD 384-7-702.S2
Ирландия	Монтажные правила + IS HD 384-7-702	Польша	PN-IEC 60364-7-702:1999
Италия	CEI 64-8/7	Чехия	CSN 33 2000 7-702
Люксембург	384-7.702 S2	Словакия	STN 33 2000-7-702
Нидерланды	NEN 1010-7-702	Словения	SIST HD 384-7-702.S2
Португалия	RSIUÉE	Турция	TS IEC 60364-7-702



**Убедитесь, что имеющиеся в наличии электропитание и частота соответствуют требуемым параметрам тока, приняв во внимание специфическую установку прибора и потребности всех других устройств, подключенных к данной цепи.**

**ENP6MASC 230 V $\sphericalangle$  +/- 10 % 50 Hz 1 Phase**

**ENP6TASC 400 V $\sphericalangle$  +/- 10 % 50 Hz 3 Phases**

**ENP7TASC 400 V $\sphericalangle$  +/- 10 % 50 Hz 3 Phases**



**Убедитесь в том, что фазовое равновесие не превышает 2%**

**Соблюдайте требования соответствующей схемы соединений в приложении.**

**Соединительная коробка находится с правой стороны устройства. Три контактных соединения предназначены для подключения электропитания, два других - для подключения механизма управления фильтрационного насоса (Системы автоматического управления).**

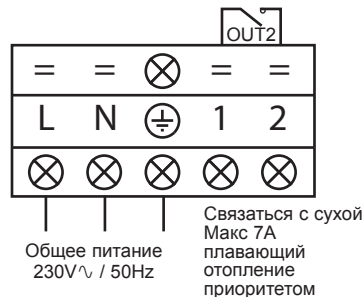
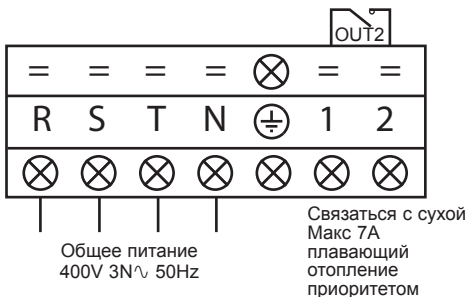

### 3. УСТАНОВКА И ПОДКЛЮЧЕНИЕ (продолжение)



*Цепь электропитания должна быть снабжена соответствующим защитным устройством (предохранителем для защиты электродвигателей и кабелей типа aM) или автоматическим выключателем (кривая D), а также дифференциальным автоматом на 30 мА (см. следующую таблицу).*

Модели		ENP6MASC	ENP6TASC	ENP7TASC
Электропитание	В/Фаза/ Гц	230V~/ 50Hz	400V 3N~/ 50Hz	400V 3N~/ 50Hz
Предел срабатывания предохранителя (*)	A	20 aM	12 aM	16 aM
Автоматический выключатель, кривая D	A	20 D	12 D	16 D
Сечение кабеля	мм <sup>2</sup>	3G6 3 x 6	5G2,5 5 x 2,5	5G2,5 5 x 2,5

(\*) тип aM, предохранитель для защиты электродвигателей и кабелей



*Используйте кабель питания типа RO 2V / R 2V или аналогичный.*



*Сечения кабеля даны из расчета максимальной длины - 25 м. Тем не менее, необходимо их проверять и адаптировать согласно условиям установки.*



*Перед открытием блока электроуправления всегда отключайте источник основного питания.*

#### 3.5 Первый запуск

Процедура запуска - после того, как закончена установка, неуклонно следуйте следующему порядку действий :

- 1) Проверните вентиляторы рукой для проверки их свободного вращения и соответствия крепления винта на валу мотора.
- 2) Убедитесь в том, что устройство правильно подключено к источнику основного питания (см. схему соединения в приложении).
- 3) Включите фильтрационный насос.
- 4) Перед тем как перейти к режимам подогрева или охлаждения, проверьте, чтобы все вентили были открыты и чтобы вода поступала в устройство.
- 5) Проверьте, чтобы трубка оттока конденсата была правильно установлена, чтобы не создавалось никаких помех.
- 6) Включите электропитание устройства, затем нажмите кнопку Пуск/ Стоп  на панели управления.

### 3. УСТАНОВКА И ПОДКЛЮЧЕНИЕ (продолжение)

- 7) Убедитесь в том, что в то время, как устройство находится в режиме ВКЛ, не горит ни один код ТРЕВОГИ (см. справочник по устранению неисправностей).
- 8) Установите пропускную способность для воды с помощью перепускного вентиля (см. § 3.6 и 2.1) на уровне, предусмотренном для соответствующей модели, так, чтобы разница температур воды на входе/выходе составляла 2°C.
- 9) После нескольких минут работы проверьте, чтобы температура воздуха, выходящего из устройства, понизилась (была между 5 и 10°).
- 10) Не выключая устройства, остановите фильтрационный насос. Устройство должно автоматически отключиться и показать код ошибки E03.
- 11) Оставьте устройство и насос плавательного бассейна включенными круглосуточно, пока температура воды не достигнет желаемого уровня. Когда температура воды на входе достигнет заданного значения, устройство отключится. Оно снова самостоятельно включится (при условии, что будет включен насос плавательного бассейна), если температура в плавательном бассейне понизится хотя бы на 0.5°C от заданной.

**Контроллер пропускной способности** - Устройство снабжено контроллером пропускной способности, который включает тепловой насос при включенном фильтрационном насосе плавательного бассейна, и отключает тепловой насос при неработающем фильтрационном насосе. При отсутствии поступления воды на экране регулятора загорится код ошибки E03 (См. § 6.4).

**Задержка** - устройство работает с задержкой в 3 минуты с целью защиты компонентов управляющей цепи, устранения любой нестабильности при повторном запуске и всех помех в цепи контактора. Благодаря данной задержке устройство автоматически включается примерно через 3 минуты после полного отключения управляющей цепи. Таким же образом кратковременное отключение тока активизирует цепь задержки включения.

**Фазовый контроллер** - Трехфазные блоки включают в себя фазовый контроллер для обеспечения правильного направления вращения компрессора. Если устройство не запускается, проверьте состояние фазового контроллера, расположенного в электрошкафе.

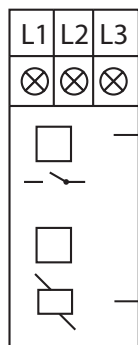

Желтый/оранжевый ВКЛ = Реле ВКЛ = Порядок и число фаз в норме

Зеленый = под напряжением

## 3. УСТАНОВКА И ПОДКЛЮЧЕНИЕ (продолжение)

### 3.6 Установка пропускной способности насоса

Открыв вентили входа и выхода воды, отрегулируйте так называемый "перепускной" вентиль так, чтобы разница между температурами воды на входе и выходе составляла 2°C (см. § 3.1 принципиальной схемы). Вы можете проверить правильность регулировки, контролируя отображаемые на командной панели значения температур воды на входе и выходе.

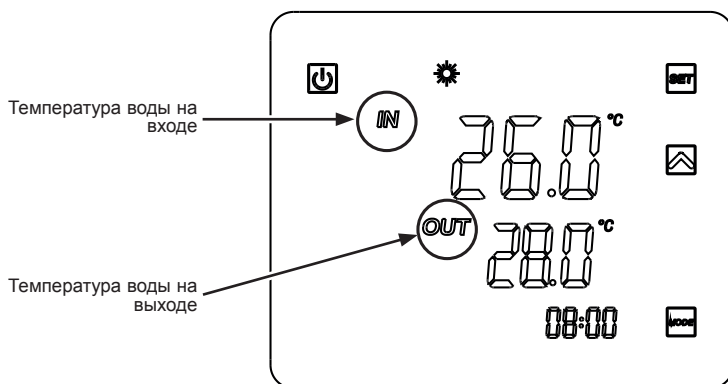

Примечание : Открытие так называемого "перепускного" вентиля понижает влияние пропускной способности на повышение разницы температур  $\Delta T$ .  
Закрытие так называемого "перепускного" вентиля повышает влияние пропускной способности на понижение разницы температур  $\Delta T$ .

## 4. ИНТЕРФЕЙС ПОЛЬЗОВАТЕЛЯ

### 4.1 Общие сведения

Тепловой насос оборудован панелью цифрового управления с тактильным экраном, соединенной электрически с устройством и настроенным на заводе на режим подогрева.

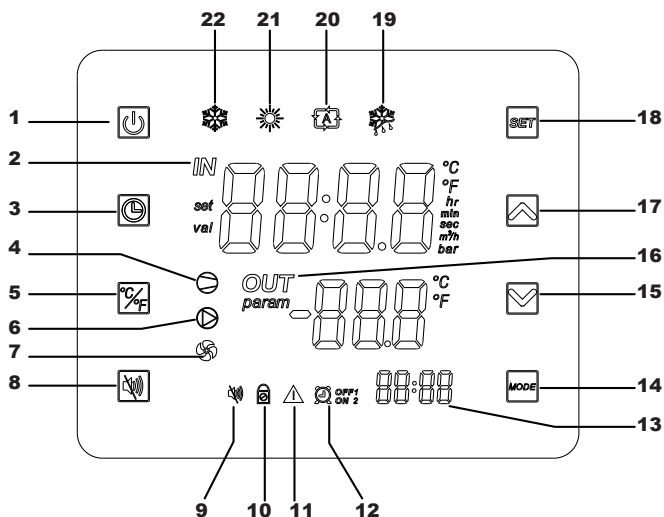

#### Условные обозначения

1		Пуск/Стоп
2	<i>IN</i>	Воды на входе
3		Установка времени и Таймера
4		Компрессор ON
5		Конвертация °C/°F
6		Сухой контакт OUT2
7		Вентилятор ON
8		Указатель режима тишины
9		Контрольный указатель режима тишины
10		Экран заблокирован
11		Тревога

12		Таймеры 1 и 2
13		Время таймеров
14	<b>MODE</b>	Выбор режима
15		Перемещение вниз/ Уменьшение
16	<i>OUT</i>	Воды на выходе
17		Перемещение вверх/ Увеличение
18	<b>SET</b>	Сохранение/Настройки
19		Режим оттаивания
20		Режим Автоматический
21		Режим Подогрева
22		Режим Охлаждения

## 4. ИНТЕРФЕЙС ПОЛЬЗОВАТЕЛЯ (продолжение)

### Режим ВЫКЛ.

Когда тепловой насос находится в спящем режиме (Режим ВЫКЛ), на экране регулятора видна надпись "ВЫКЛ".

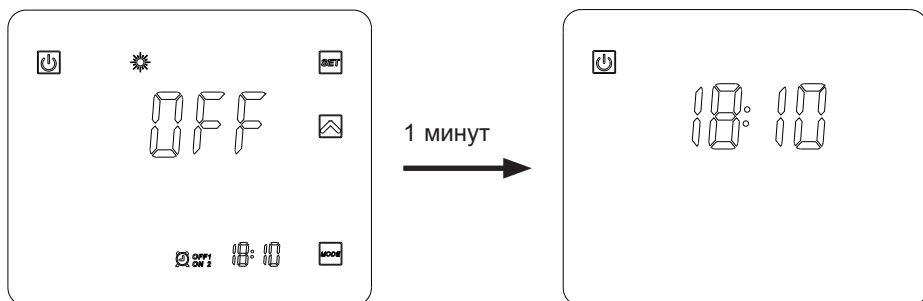

### Режим ВКЛ.

Когда тепловой насос находится в рабочем или регулировочном режиме (Режим ВКЛ), на экране регулятора отражаются температура воды на входе и выходе.

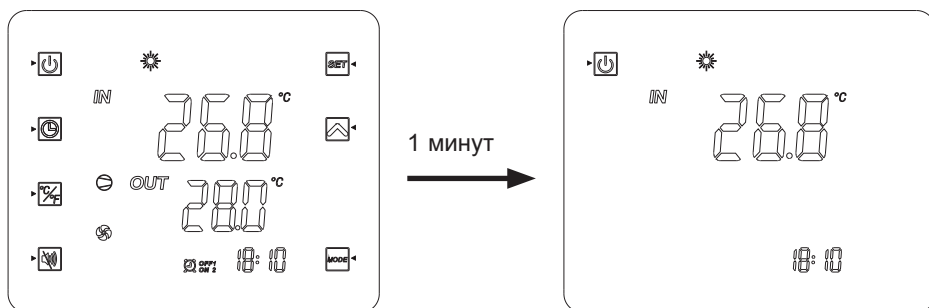









## 4. ИНТЕРФЕЙС ПОЛЬЗОВАТЕЛЯ (продолжение)

В конце настройки нажмите  для подтверждения.

Параметры записи автоматически после 20-х годов без действия.

### 4.2 Установка времени

Если экран находится в спящем режиме, коротко нажмите на кнопку .









- 1) Нажмите  для отображения символа .
- 2) Нажмите , отображаемое время станет мигать. Настройте часы при помощи кнопок  .
- 3) Нажмите  затем установите минуты при помощи кнопок  .
- 4) Подтвердите нажатием на .

### 4.3 Настройка функции Таймер











Установка этой функции нужна в том случае, если Вы хотите, чтобы тепловой насос работал в течение более короткого периода времени по сравнению с установленным временем фильтрации. Вы также можете запрограммировать произвольное время включения и выключения или просто отключить временной рабочий диапазон (например, ночью).



Существует возможность программирования двух Таймеров Запуска (ON1 и ON2) и двух Таймеров Остановки (OFF1 и OFF2).

#### Программирование Таймера 1 – Départ

- 1) Поддержка в течение  2с, Таймер ON1  <sup>1</sup> начнет мигать (\*).
- 2) Нажмите  для настройки часов при помощи кнопок  .
- 3) Нажмите  для настройки минут при помощи кнопок  .
- 4) Подтвердите нажатием на .

#### Программирование Таймера 1 – Остановка



- 1) Поддержка в течение  2с, Таймер ON1  <sup>1</sup> начнет мигать (\*).  
Однократно нажмите на , Таймер OFF1  <sup>1</sup> начнет мигать.
- 2) Нажмите  для настройки часов при помощи кнопок  .
- 3) Нажмите  для настройки минут при помощи кнопок  .
- 4) Подтвердите нажатием на .

(\*) Для прямого перехода к Таймеру ON2  <sup>2</sup> удерживайте   
в течение 2с, затем дважды нажмите на .



## 4. ИНТЕРФЕЙС ПОЛЬЗОВАТЕЛЯ (продолжение)

### Программирование Таймера 2

















После настройки Таймера 1 осуществляется прямой переход к Таймеру 2:

 **ON 2** И  **OFF 2**.

Выполняйте те же действия, что и для Таймера 1.

**нота:** Для прямого перехода к Таймеру ON2  **ON 2** удерживайте  в течение 2с, затем дважды нажмите на .

### Удаление Таймеров (Запуск и Остановка)

- 1) Поддержка в течение  2с, Таймер ON1  **ON 1** начнет мигать. (\*)
  - 2) Нажмите , отображаемое время станет мигать.
  - 3) Нажмите  для удаления Таймера  **ON 1**.
  - 4) Нажмите  для подтверждения.
  - 5) Поддержка в течение  2с, Таймер ON1  **ON 1** начнет мигать. Однократно нажмите на , Таймер  **OFF 1** начнет мигать. (\*)
  - 6) Нажмите , отображаемое время станет мигать.
  - 7) Нажмите  для удаления Таймера  **OFF 1**.
- (\*) Для доступа к Таймерам 2  **ON 2** или  **OFF 2**, выполните этапы 1) или 4), затем дважды нажмите на . Выполните вышеуказанные действия.

## 4.4 Выбор режима работы: охлаждение, нагрев или автоматический

### В Режиме “ВЫКЛ.” или “ВКЛ.”

Нажмите кнопку  для переключения режимов: охлаждение, нагрев или автоматический.

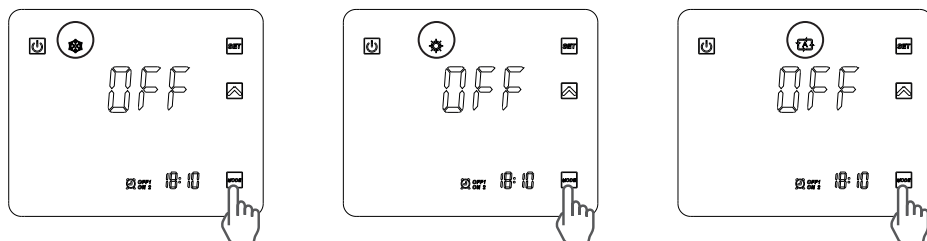



**Если тепловой насос установлен в отопления или охлаждения в режим только, смена режима не возможно.**





## 4. ИНТЕРФЕЙС ПОЛЬЗОВАТЕЛЯ (продолжение)

### 4.5 Установка и визуализация заданного значения (Желаемая температура воды)

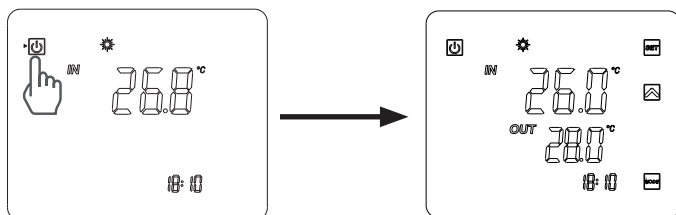
Если кнопку  не видно на экране, коротко нажмите на . (Во время работы или при остановке достаточно нажать кнопку  для отображения заданного значения.)





#### В Режиме "ВЫКЛ." и Режиме "ВКЛ."



Нажмите кнопку  для отображения заданного значения, затем нажмите на  или  для определения необходимого заданного значения. Установка возможна с шагом 0,5 °С.



*Чтобы избежать деформации жаровых трубок, рекомендуется никогда не превышать температуру 30°C.*

### 4.6 Блокировка и разблокировка тактильного экрана

Нажать на кнопку Пуск/Стоп  на 5 сек., пока не раздастся звуковой сигнал и не появится символ .

Для разблокировки нажать  на 5 сек., пока не раздастся звуковой сигнал и не исчезнет символ .

## 4. ИНТЕРФЕЙС ПОЛЬЗОВАТЕЛЯ (продолжение)

### 4.7 Настройка функции бесшумного режима SILENCE (🔇)

Эта функция позволяет использовать тепловой насос со скоростью вращения лопастей вентилятора, сниженной до 600 об./мин. для ENP6MASC, 830 об./мин. для ENP6TASC и 800 об./мин. для ENP7TASC в течение максимум 8 часов, чтобы уменьшить уровень шума в ночное и/или дневное время согласно местонахождению теплового насоса по отношению к окрестным жилым домам и/или водоемам.



Эта функция может быть активирована/деактивирована вручную или с помощью таймера.

#### Активация режима вручную

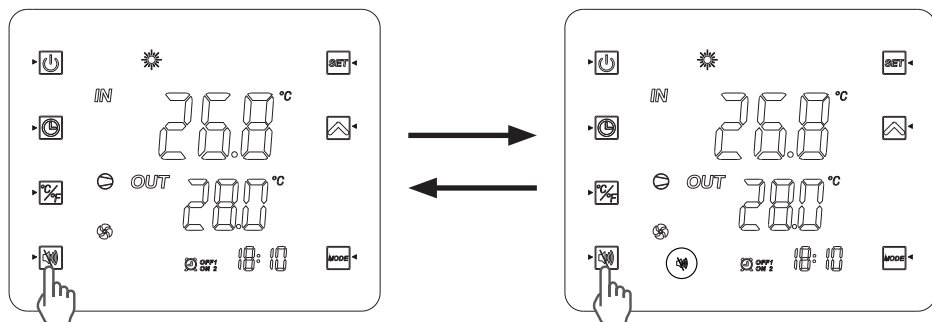
- 1) Нажмите на кнопку .
- 2) Нижеуказанное отображение появится на экране, режим Тишина активирован на 8 ближайших часов.
- 3) Скорость вращения вентиляторов постепенно будет снижаться до и сохранится в течение не более 8 часов.
- 4) Через 8 часов работы функция будет автоматически отключена, и скорость вращения вентиляторов восстановится в зависимости от внешней температуры воздуха.



#### Ручная деактивация

- 1) Нажмите на кнопку .
- 2) Контрольный указатель  пропадет с экрана: режим Тишина отключен.
- 3) Вентиляторы устанавливают скорость вращения в зависимости от внешней температуры воздуха

## 4. ИНТЕРФЕЙС ПОЛЬЗОВАТЕЛЯ (продолжение)



### Настройка беззвучного режима

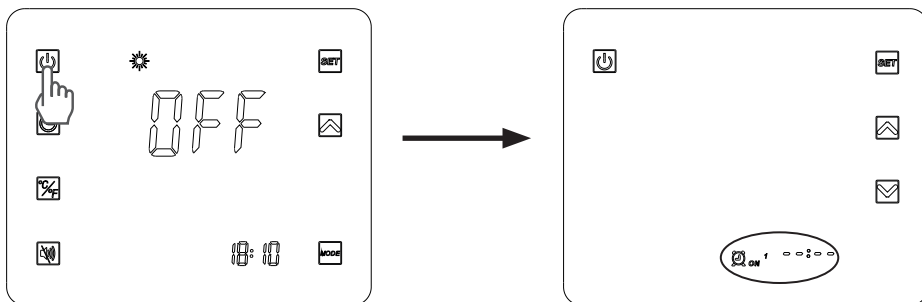

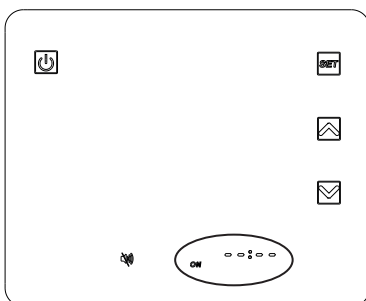

1) Поддержка в течение  2с, Таймер ON1  ON<sup>1</sup> начнет мигать.



2) Нажмите 4 раза на  до появления нижеуказанного экрана.



3) Нажмите , отображаемые часы станут мигать. Используйте стрелки   для настройки часов запуска.





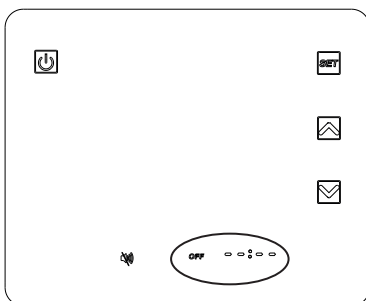



4) Нажмите , отображаемые минуты станут мигать. Используйте стрелки   для настройки минут запуска. Подтвердите нажатием на .

5) Нажмите  для настройки времени окончания: индикация OFF начнет мигать.



## 4. ИНТЕРФЕЙС ПОЛЬЗОВАТЕЛЯ (продолжение)

---

- 6) Нажмите , отображаемые часы станут мигать. Используйте стрелки   для настройки часа окончания.
- 7) Нажмите , отображаемые минуты станут мигать. Используйте стрелки   для настройки минут окончания. Подтвердите нажатием на .
- 8) Нажмите  для возврата на предыдущий экран.  
Индикаторы ON-OFF отображаются так, как указано ниже.

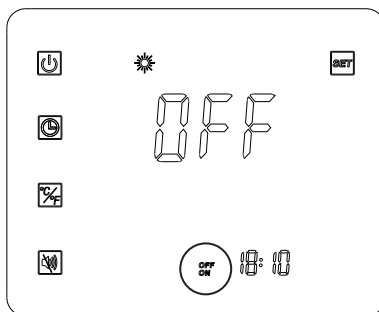

**нота:** Шаг интервала для настройки минут равен 10.

После завершения настройки бесшумного режима он остается активированным по умолчанию 7 дней в неделю.

## 5. ТЕХНИЧЕСКОЕ ОБСЛУЖИВАНИЕ И КОНСЕРВАЦИЯ НА ЗИМУ

---

### 5.1 Техническое обслуживание

Для гарантирования продолжительной и надежной работы теплового насоса рекомендуется раз в год проводить следующие операции по обслуживанию устройства.

- Очистите испаритель с помощью мягкой зубной щетки или воздушной/водяной струи (**Внимание: никогда не используйте для очистки высокое давление**).
- Проверьте, что конденсат хорошо стекает.
- Проверьте надежность гидротехнических и электрических соединений.
- Проверьте гидравлическую герметичность конденсатора.



*Перед производством любых работ по техническому обслуживанию теплового насоса необходимо отсоединить его от источника питания. Все операции по техническому обслуживанию должны производиться только специально подготовленным персоналом, имеющим опыт работы с жидкими хладагентами.*

### 5.2 Консервация на зиму

- Переведите тепловой насос в режим "ВЫКЛ."
- Отключите тепловой насос от источника питания.
- Слейте содержимое конденсатора для предотвращения риска повреждения (риск возможного замерзания).
- Закройте "перепускной" вентиль и отсоедините штуцерные соединения входа/выхода.
- С помощью пистолета высокого давления максимально выдуйте остатки воды из конденсатора.
- Перекройте вход и выход для воды теплового насоса для предотвращения попадания туда инородных тел.
- Укройте тепловой насос предназначенным для этих целей зимним чехлом.



*Любые неполадки, вызванные неправильной консервацией на зимний период, аннулируют гарантию.*

# 6. ПРИЛОЖЕНИЯ

## 6.1 Электрические схемы

### ENP6MASC

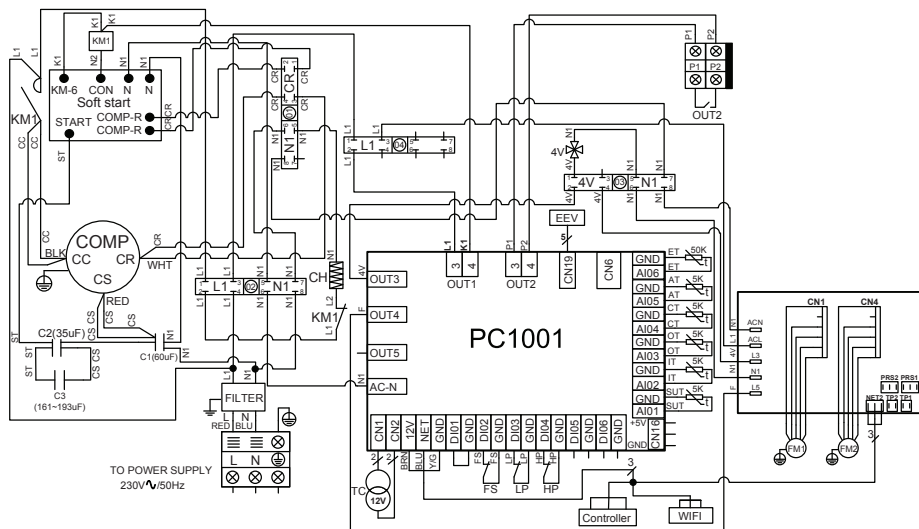

#### ПРИМЕЧАНИЯ :

1. AT : ДАТЧИК ТЕМПЕРАТУРЫ ВОЗДУХА
2. COMP : КОМПРЕССОР
3. СТ : ДАТЧИК ТЕМПЕРАТУРЫ ИСПАРИТЕЛЯ
4. EEV : ЭЛЕКТРОННЫЙ РЕДУКТОР
5. FM1-2 : МОТОР ВЕНТИЛЯТОРА
6. FS : ДЕТЕКТОР НАЛИЧИЯ ВОДЫ
7. HP : ПРЕССОСТАТ ВЫСОКОГО ДАВЛЕНИЯ
8. IT : ДАТЧИК ТЕМПЕРАТУРЫ ВОДЫ НА ВХОДЕ
9. LP : ПРЕССОСТАТ НИЗКОГО ДАВЛЕНИЯ
10. OT : ДАТЧИК ТЕМПЕРАТУРЫ ВОДЫ НА ВЫХОДЕ
11. SUT : ДАТЧИК ТЕМПЕРАТУРЫ ВСАСЫВАНИЯ
12. TC : ТРАНСФОРМАТОР 230 В $\sim$  / 12 В $\sim$
13. 4V : 4-Х КАНАЛЬНЫЙ ВЕНТИЛЬ
14. KM1 : КОНТАКТОР МОЩНОСТИ
15. SOFT STARTER : Электронный пусковой механизм
16. CH : СОПРОТИВЛЕНИЕ КОЖУХА
17. ET : ДАТЧИК ТЕМПЕРАТУРЫ НАГРЕТАНИЯ
18. OUT2 : СВОБОДНЫЙ КОНТАКТ С МАКСИМАЛЬНЫМ ПОТЕНЦИАЛОМ 7А

## 6. ПРИЛОЖЕНИЯ (продолжение)

### ENP6TASC - ENP7TASC

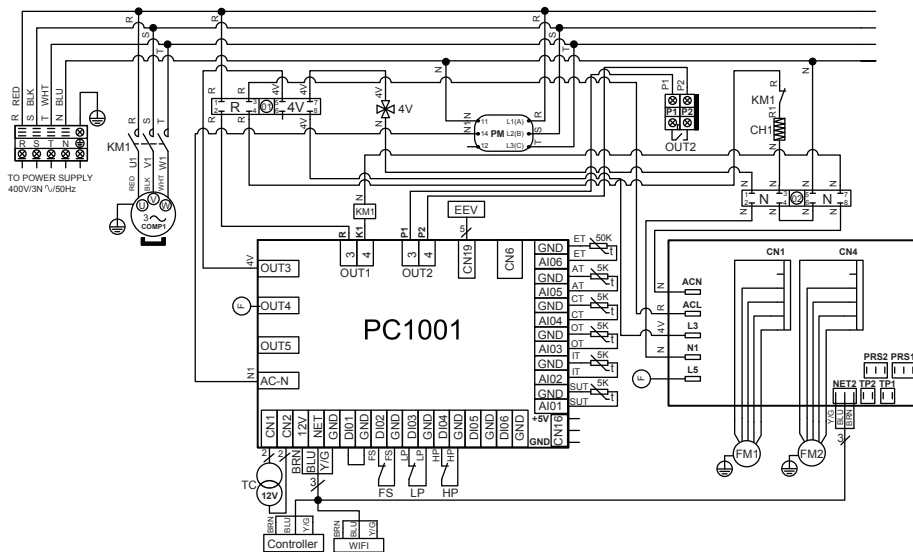

#### ПРИМЕЧАНИЯ :

1. AT : ДАТЧИК ТЕМПЕРАТУРЫ ВОЗДУХА
2. COMP : КОМПРЕССОР
3. CT : ДАТЧИК ТЕМПЕРАТУРЫ ИСПАРИТЕЛЯ
4. EEV : ЭЛЕКТРОННЫЙ РЕДУКТОР
5. FM1-2 : МОТОР ВЕНТИЛЯТОРА
6. FS : ДЕТЕКТОР НАЛИЧИЯ ВОДЫ
7. HP : ПРЕССОСТАТ ВЫСОКОГО ДАВЛЕНИЯ
8. IT : ДАТЧИК ТЕМПЕРАТУРЫ ВОДЫ НА ВХОДЕ
9. LP : ПРЕССОСТАТ НИЗКОГО ДАВЛЕНИЯ
10. OT : ДАТЧИК ТЕМПЕРАТУРЫ ВОДЫ НА ВЫХОДЕ
11. SUT : ДАТЧИК ТЕМПЕРАТУРЫ ВСАСЫВАНИЯ
12. TC : ТРАНСФОРМАТОР 230 В $\sim$  / 12 В $\sim$
13. 4V : 4-Х КАНАЛЬНЫЙ ВЕНТИЛЬ
14. KM1 : КОНТАКТОР МОЩНОСТИ
15. PM : ФАЗОВЫЙ КОНТРОЛЛЕР
16. CH1 : СОПРОТИВЛЕНИЕ КОЖУХА
17. ET : ДАТЧИК ТЕМПЕРАТУРЫ НАГРЕТАНИЯ
18. OUT2 : СВОБОДНЫЙ КОНТАКТ С МАКСИМАЛЬНЫМ ПОТЕНЦИАЛОМ 7А

## 6. ПРИЛОЖЕНИЯ (продолжение)

### 6.2 Включение подогрева в качестве приоритета

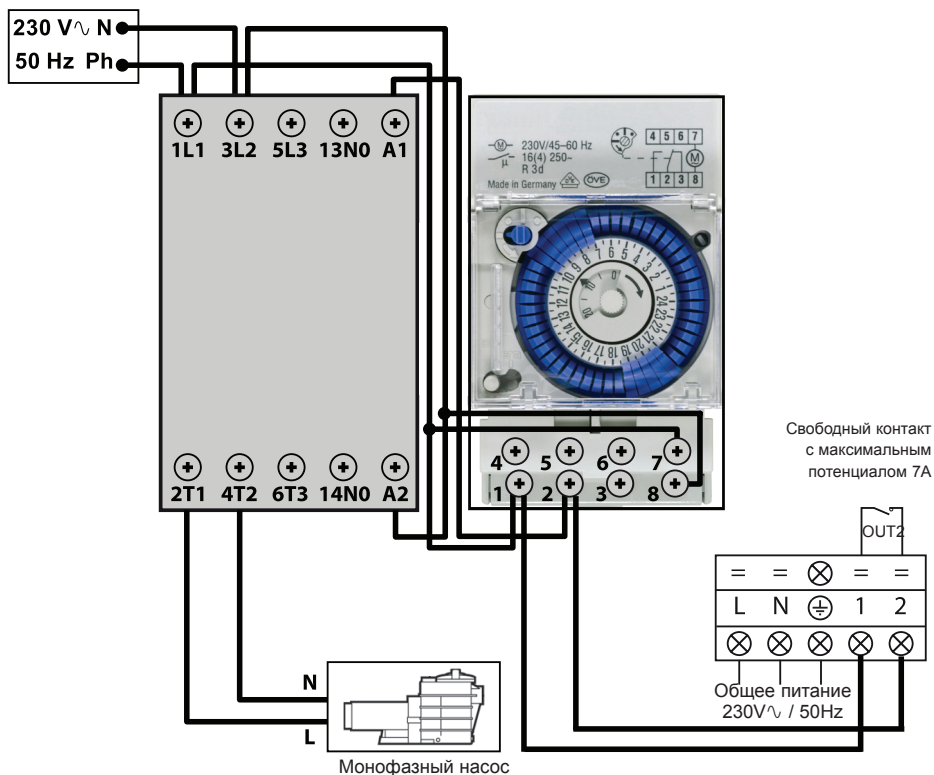

Разъемы 1 и 2 обеспечивают подачу питания на бесполярный контакт при напряжении 230V~ / 50Hz. Подключите кабели к разъемам 1 и 2 в соответствии с указанной монтажной схемой для автоматической регулировки насоса фильтрации по циклам в 2 минуты каждый час, когда температура резервуара снижается ниже установленного значения.

 **Никогда не подключать питание фильтрационного насоса прямо к клеммам 1 и 2.**





## 6. ПРИЛОЖЕНИЯ (продолжение)

### 6.2 Включение подогрева в качестве приоритета для трехфазного насоса

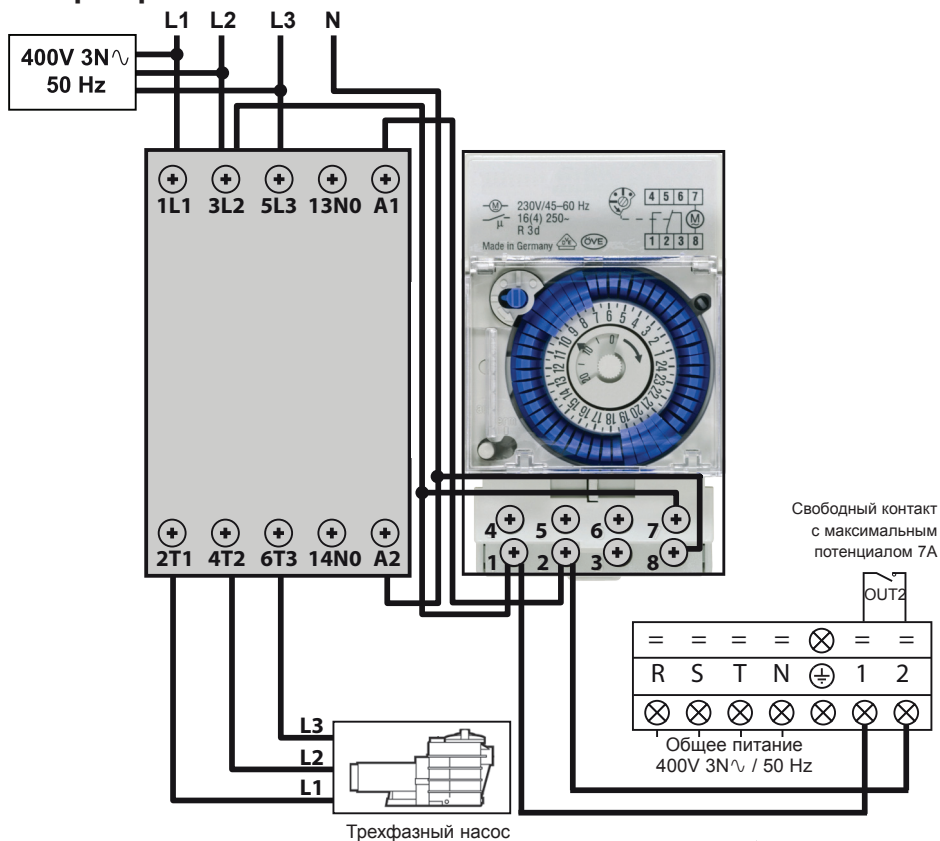

Разъемы 1 и 2 обеспечивают подачу питания на бесполярный контакт при напряжении 230V $\sim$  / 50Hz. Подключите кабели к разъемам 1 и 2 в соответствии с указанной монтажной схемой для автоматической регулировки насоса фильтрации по циклам в 2 минуты каждый час, когда температура резервуара снижается ниже установленного значения.

 **Никогда не подключать питание фильтрационного насоса прямо к клеммам 1 и 2.**





## 6. ПРИЛОЖЕНИЯ (продолжение)

### ENP6MASC

Индикация	Справочный номер	Название	Индикация	Справочный номер	Название
1	HWX20000270004	Винт вентилятора	28	HWX32019210028	Левая панель
2	HWX200011112	компрессор	29	HWX32019210031	Защита испарителя
3	HWX20003214	Сопротивление кожуха	30	HWX20003242	Датчик температуры воздуха
4	HWX32008220037	Рукоятка	31	HWX32010120008	Испаритель
5	HWX32019210040	Электрошкаф	32	HWX20003242	Датчик воды на входе
6	HWX20003920	Клеммная колодка на 3 контактов	33	HWX20013605	Прессостат высокого давления
7	HWX20003909	Клеммная колодка на 2 контактов	34	HWX20003242	Датчик температуры испарителя
8	HWX20003933	Клеммная колодка на 3 контактов	35	HWX32010120023	Охладитель из ПВХ Titane
9	HWX20003504	Конденсатор компрессора (35 мкФ)	36	HWX20003603	Прессостат низкого давления
10	HWX20003510	Конденсатор компрессора (60 мкФ)	37	HWX20011491	4-х канальный вентиль
11	HWX20000350011	Пусковой конденсатор (193 мкФ)	38	HWX20000140346	Электронный редуктор
12	HWX20003254	фильтр ЭМС	39	HWX20000140353	Отбор давления высокого & низкого
13	HWX200036007	Контактор Компрессора	40	HWX20000140353	Отбор давления высокого & низкого
14	HWX32010210013	Правая панель	41	HWX200036005	Детектор пропускной способности
15	HWX20003151	Электронный пусковой механизм	42	HWX20003242	Датчик воды на выходе
16	HWX200037003	Трансформатор 230 В <sub>~</sub> - 12 В <sub>~</sub>	43	HWX32019210061	Дно
17	HWX32009220032	Лючок доступа к электроконтактам	44	HWX32019210049	Передняя панель
18	HWX32019210025	Защитная панель электроотсека	45	HWX32019210026	Разделительная панель
19	HWX20001440	Резервуар для жидкости	46	HWX20000230596	Логотип Hayward
20	HWX32019220001	Верхняя панель	47	HWX20000220169	Защитная сетка вентилятора
21	HWX95053114512E	Электронная плата	48	HWX32019210022	Опора Мотора
22	HWX950531024103	Двигатель постоянного тока	49	HWX20000330132	Двигатель постоянного тока
*23*	HWX20003223	Зонд компрессор 50кΩ	*50*	HWX20002625	Амортизирующий блок
24	/		*51*	HWX200026009	Уплотнительное кольцо ID 43-Ер 3,4 мм
25	HWX95005010018	Светодиодный регулятор	*52*	HWX200026061	Уплотнительное кольцо ID 48-Ер 5 мм
26	HWX32019210030	Ребро жесткости крупное	*53*	HWX20000240112	Защита от атмосферных осадков
27	HWX32019210029	Ребро жесткости малое	*54*	HWX20001345	Сливная пробка

Примечание: Метки \*xx\* не обозначены на соответствующем покомпонентном изображении.

## 6. ПРИЛОЖЕНИЯ (продолжение)

### 6.3 Вид в разборе и съемные элементы ENP6TASC

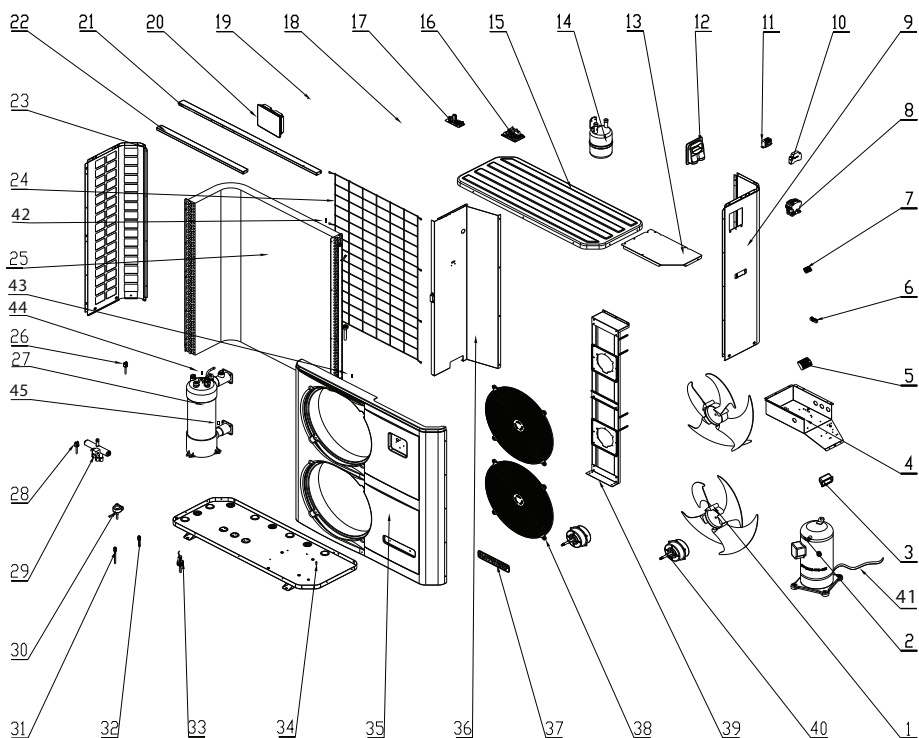

## 6. ПРИЛОЖЕНИЯ (продолжение)

### ENP6TASC

Индикация	Справочный номер	Название	Индикация	Справочный номер	Название
1	HWX20000270004	Винт вентилятора	26	HWX20013605	Прессостат высокого давления
2	HWX20000110146	Компрессор	27	HWX32019120007	Охладитель из ПВХ Titane
3	HWX32008220037	Рукоятка	28	HWX20003603	Прессостат низкого давления
4	HWX32019210024	Электрошкаф	29	HWX20011491	4-х канальный вентиль
5	HWX20003902	Контакт 5 соедин. Разд.	30	HWX20000140346	Электронный редуктор
6	HWX20003909	Клеммная колодка на 2 контактов	31		
7	HWX20003933	Клеммная колодка на 3 контактов	32		
8	HWX20003653	Контактор Компрессора TRI	33	HWX200036005	Детектор пропускной способности
9	HWX32019210027	Правая панель	34	HWX32019210061	Дно
10	HWX200036023	Фазовый контроллер	35	HWX32019210049	Передняя панель
11	HWX200037003	Трансформатор 230 В <sup>~</sup> - 12 В <sup>~</sup>	36	HWX32019210026	Разделительная панель
12	HWX32009220032	Лючок доступа к электроконтактам	37	HWX20000230596	Логотип Hayward
13	HWX32019210025	Защитная панель электроотсека	38	HWX20000220169	Защитная сетка вентилятора
14	HWX20001440	Резервуар для жидкости	39	HWX32019210022	Опора Мотора
15	HWX32019220001	Верхняя панель	40	HWX20000330132	Двигатель постоянного тока
16	HWX95053114510E	Электронная плата	41	HWX20003214	Сопротивление кожуха
17	HWX950531024101	Двигатель постоянного тока	42	HWX20003242	Датчик температуры воздуха
*18*	HWX20003223	Зонд компрессор 50kΩ	43		Датчик температуры испарителя
19	/	/	44		Датчик воды на входе
20	HWX95005010018	Светодиодный регулятор	45		Датчик воды на выходе
21	HWX32019210030	Ребро жесткости крупное	*46*	HWX20002625	Амортизирующий блок
22	HWX32019210029	Ребро жесткости малое	*47*	HWX200026009	Уплотнительное кольцо ID 48-Ер 5 мм
23	HWX32019210028	Левая панель	*48*	HWX200026061	Уплотнительное кольцо ID 43-Ер 3,4 мм
24	HWX32019210031	Защита испарителя	*49*	HWX20000240112	Защита от атмосферных осадков
25	HWX32010120008	Испаритель	*50*	HWX20001345	Сливная пробка

Примечание: Метки \*xx\* не обозначены на соответствующем покомпонентном изображении.

## 6. ПРИЛОЖЕНИЯ (продолжение)

ENP7TASC

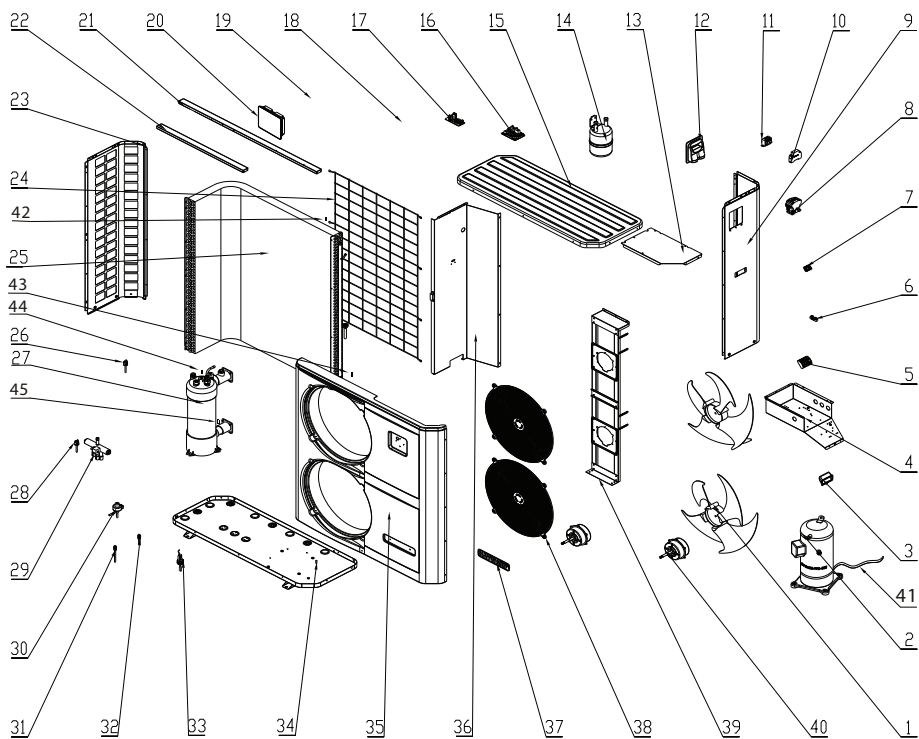

## 6. ПРИЛОЖЕНИЯ (продолжение)

### ENP7TASC

Индикация	Справочный номер	Название	Индикация	Справочный номер	Название
1	HWX20000270004	Винт вентилятора	26	HWX20013605	Прессостат высокого давления
2	HWX20000110138	Компрессор	27	HWX32019120007	Охладитель из ПВХ Titane
3	HWX32008220037	Рукоятка	28	HWX20003603	Прессостат низкого давления
4	HWX32019210024	Электрощкаф	29	HWX20011491	4-х канальный вентиль
5	HWX20003902	Контакт 5 соед. Разд.	30	HWX20000140398	Электронный редуктор
6	HWX20003909	Клеммная колодка на 2 контактов	31		/
7	HWX20003933	Клеммная колодка на 3 контактов	32		/
8	HWX20003653	Контактор Компрессора TRI	33	HWX200036005	Детектор пропускной способности
9	HWX32019210027	Правая панель	34	HWX32019210061	Дно
10	HWX200036023	Фазовый контроллер	35	HWX32019210049	Передняя панель
11	HWX200037003	Трансформатор 230 В <sup>~</sup> - 12 В <sup>~</sup>	36	HWX32019210026	Разделительная панель
12	HWX32009220032	Лючок доступа к электроконтактам	37	HWX20000230596	Логотип Hayward
13	HWX32019210025	Защитная панель электроотсека	38	HWX20000220169	Защитная сетка вентилятора
14	HWX20001440	Резервуар для жидкости	39	HWX32019210022	Опора Мотора
15	HWX32019220001	Верхняя панель	40	HWX20000330132	Двигатель постоянного тока
16	HWX95053114511E	Электронная плата	41	HWX20003214	Сопротивление кожуха
17	HWX950531024102	Module DC Inverter	42	HWX20003242	Датчик температуры воздуха
*18*	HWX20003223	Зонд компрессор 50kΩ	43		Датчик температуры испарителя
19	/	/	44		Датчик воды на входе
20	HWX95005010018	Светодиодный регулятор	45		Датчик воды на выходе
21	HWX32019210030	Ребро жесткости крупное	*46*	HWX20002625	Амортизирующий блок
22	HWX32019210029	Ребро жесткости малое	*47*	HWX200026009	Уплотнительное кольцо ID 48-Ер 5 мм
23	HWX32019210028	Левая панель	*48*	HWX200026061	Уплотнительное кольцо ID 43-Ер 3,4 мм
24	HWX32019210031	Защита испарителя	*49*	HWX20000240112	Защита от атмосферных осадков
25	HWX32019120002	Испаритель	*50*	HWX20001345	Сливная пробка

Примечание: Метки \*xx\* не обозначены на соответствующем покомпонентном изображении.

## 6. ПРИЛОЖЕНИЯ (продолжение)

---



### 6.4 Справочник по устранению неисправностей

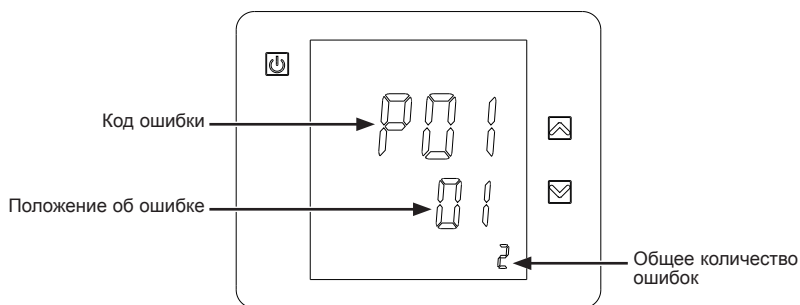

*Некоторые операции должны выполняться квалифицированными специалистами.*

В случае неисправности следующие индикаторы появятся на экране:



В случае повторяющейся ошибки, нажмите  или  и прокрутите коды ошибок. См. таблицу ниже.

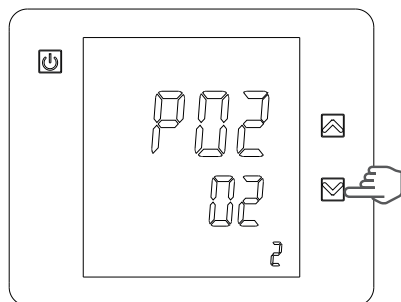



## 6. ПРИЛОЖЕНИЯ (продолжение)

Неисправности	Коды ошибок	Описание	Устранение
Неисправность датчика воды на входе	P01	Датчик открыт или произошло короткое замыкание.	Проверить или заменить датчик.
Неисправность датчика воды на выходе	P02	Датчик открыт или произошло короткое замыкание.	Проверить или заменить датчик.
Неисправность датчика оттаивания	P05	Датчик открыт или произошло короткое замыкание.	Проверить или заменить датчик.
Неисправность датчика температуры окружающей среды	P04	Датчик открыт или произошло короткое замыкание.	Проверить или заменить датчик.
Отсутствие зонда всасывания компрессора	P07	Датчик открыт или произошло короткое замыкание.	Проверить или заменить датчик.
Слишком большая разница температур воды на выходе и на входе	E06	Недостаточная пропускная способность, разница давления воды незначительна / чрезмерна.	Проверить пропускную способность или наличие закупоривания системы.
Защита от замерзания Холодный режим	E07	Количество воды на выходе слишком мало.	Проверить пропускную способность или датчик температуры воды на выходе.
Защита от замерзания - уровень 1	E19	Температура окружающей среды или воды на входе слишком низкая.	
Защита от замерзания - уровень 2	E29	Температура окружающей среды или воды на входе еще ниже.	
Защита от высокого давления	E01	Давление в холодильной системе слишком высокое, или пропускная способность слишком низкая, или засорен испаритель, или приток воздуха слишком слабый.	Проверить прессиостат высокого давления и давление в холодильной системе. Проверить пропускную способность в отношении воды и воздуха. Проверить исправность контроллера пропускной способности. Проверить, открыты ли вентили на входе и выходе воды. Проверить регулировку перепускной системы.
Защита от низкого давления	E02	Давление в холодильной системе слишком низкое, или слабый приток воздуха, или закупорен испаритель.	Проверьте прессиостат низкого давления и давление в холодильной системе, чтобы убедиться в наличии возможной утечки. Очистить поверхность испарителя. Проверить скорость вращения вентилятора. Проверить наличие свободного доступа воздуха к испарителю.
Неисправность детектора пропускной способности	E03	Недостаточная пропускная способность в отношении воды, или короткое замыкание детектора, или детектор неисправен	Проверьте пропускную способность в отношении воды, фильтрационный насос и детектор пропускной способности на предмет возможных неисправностей.
Сбои в передаче информации	E08	Неисправность светодиодного контроллера или плохое подключение блока управления процессором.	Проверьте соединение кабелей NET и NET 1.
Компрессор не запускается	E08	не хватает фазы или неверный порядок фаз	проверить наличие 3 фаз изменить порядок фаз на уровне контакта электрического подключения теплового насоса

## 6. ПРИЛОЖЕНИЯ (продолжение)

---

### 6.5 Гарантия

#### ГАРАНТИЙНЫЕ ОБЯЗАТЕЛЬСТВА

На всю продукцию компании HAYWARD в течение двух лет с момента приобретения распространяется гарантия отсутствия дефектов, связанных с работой или материалами. Настоящая гарантия действительна лишь при предъявлении документа, подтверждающего факт и дату покупки. В связи с этим мы рекомендуем сохранять товарный чек.

Гарантия компании HAYWARD сводится лишь к ремонту или замене, по выбору компании HAYWARD, дефектного изделия при условии его нормальной эксплуатации в соответствии с требованиями инструкции по эксплуатации, отсутствия каких-либо модификаций изделия и использования компонентов и запасных частей исключительно компании HAYWARD.

Действие гарантии не распространяется на последствия воздействия мороза и химических веществ. Все прочие расходы (доставка, производство работ, ...) не включены в гарантию.

Компания HAYWARD не несет ответственности за любой ущерб, прямой или косвенный, являющийся следствием неправильной установки, подключения или работы изделия.

Для того чтобы воспользоваться гарантией и потребовать возмещения стоимости или замены изделия, обратитесь к Вашему продавцу. Возврат изделия на завод-изготовитель невозможен без нашего предварительного письменного согласия. Гарантия не распространяется на быстроизнашивающиеся детали.



**HAYWARD POOL EUROPE**

Parc Industriel de la Plaine de l'Ain  
Allée des Chênes  
01150 Saint-Vulbas  
France  
<http://www.hayward.fr>

